

# Modelling and Simulation Made Easy with Simulink®

**Tiffany Liang**  
Application Engineer  
MathWorks

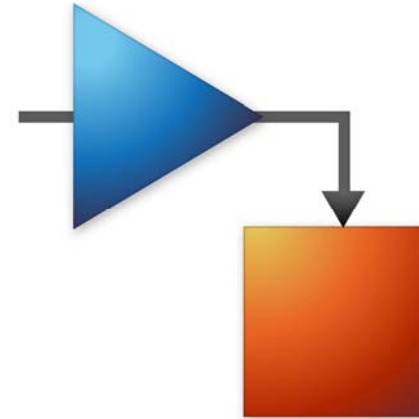

## What will you learn in this presentation?

- For those who are not familiar with Simulink and for those who are about to start using Simulink, you might have been wondering:

- **What is Simulink?**
- **Why Simulink?**
- **Where and how can Simulink be used?**

In this presentation you will be able to find out the answers to these questions.

# What is Simulink?

An Environment for Modelling and Simulation.



# What is the purpose of modelling and simulation in the first place?

- To run tests that are impossible or hard to reproduce with the actual object in the real world.
  - Dangerous
  - High Cost
  - Physically Impossible / Difficult
- To investigate the functionality and performance of the phenomenon in interest.
  - Insights of Physics Based Phenomenon
  - Parameter Study
  - Visualization of Phenomenon that are not Visible to Eyes.

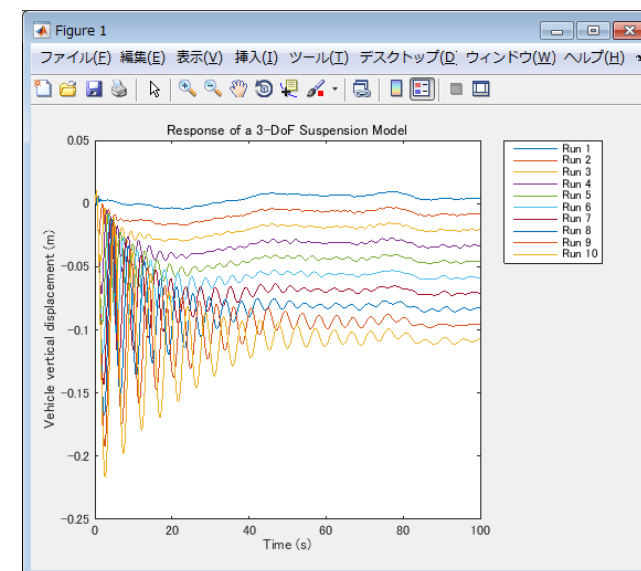

# Why Simulink?

- User friendly block diagram environment

- Clear data and processing flow.
- Easy to realize and to share ideas.

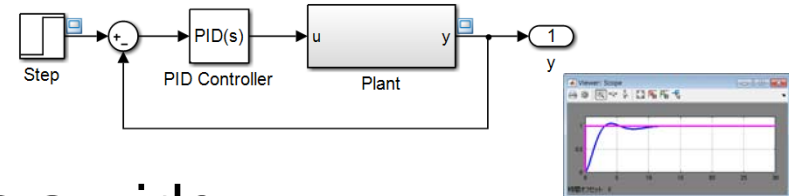

- Flexible environment that covers a wide range of different application areas

- Dynamic System, Event-Driven System.
- Physical Modelling, Control System, Signal Processing.

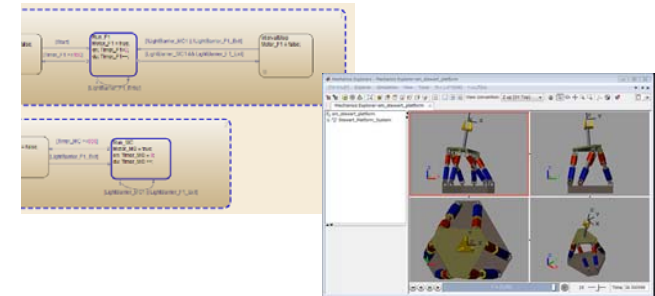

- Complete integration with MATLAB environment.

- Batch simulation by scripts.
- Access to various design, analysis and technical computing libraries.

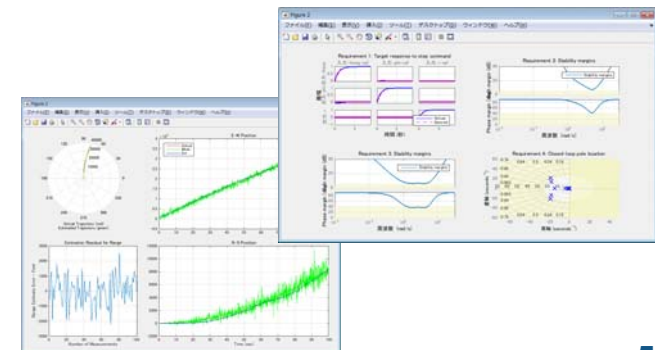

# Diverse needs met by Simulink

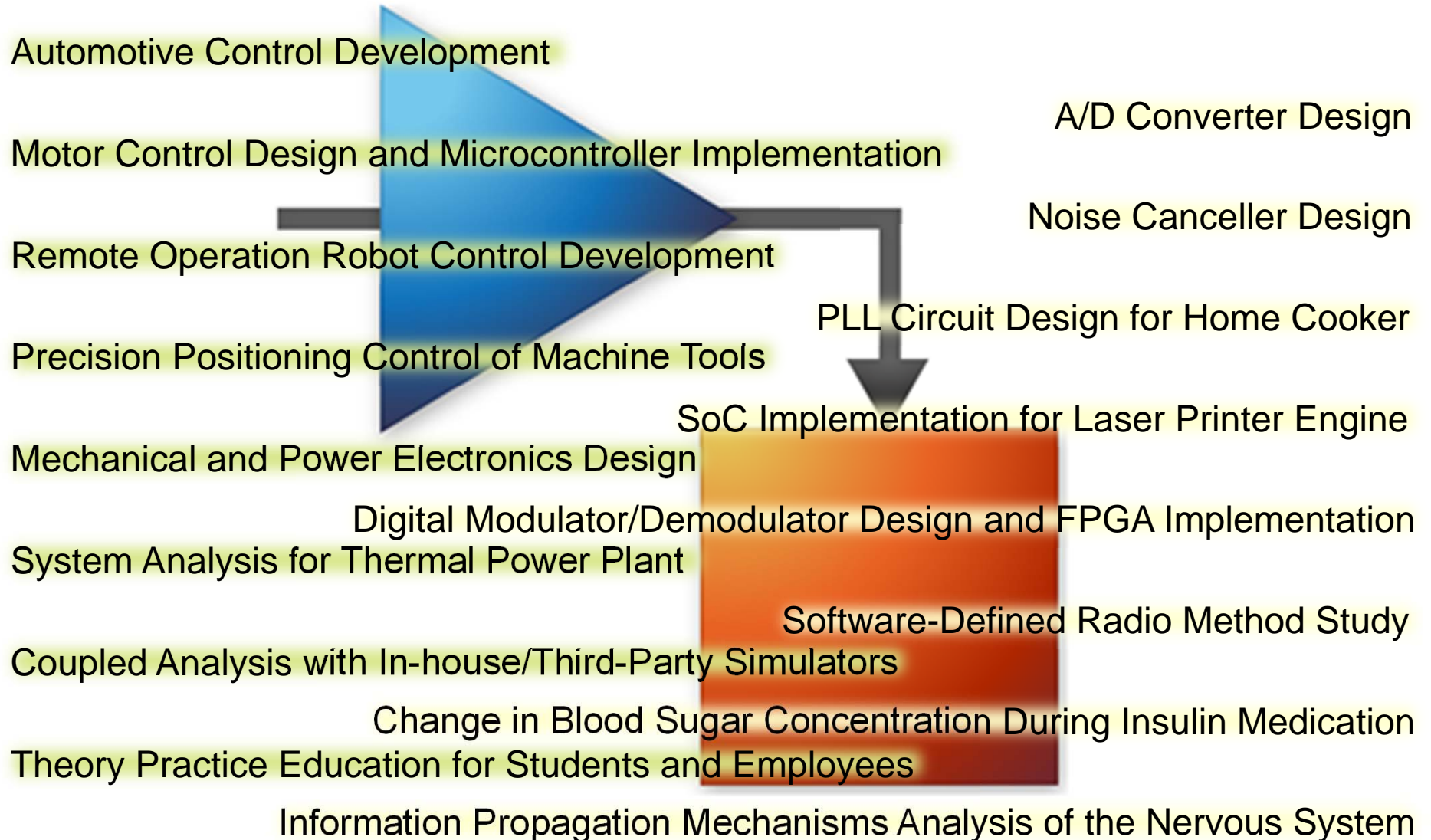

# Demo: The Clapper

## A System Modelling and Simulation Demo



Detecting the “Clap”  
via microphone.



Switching On/Off  
based on the  
numbers of claps.

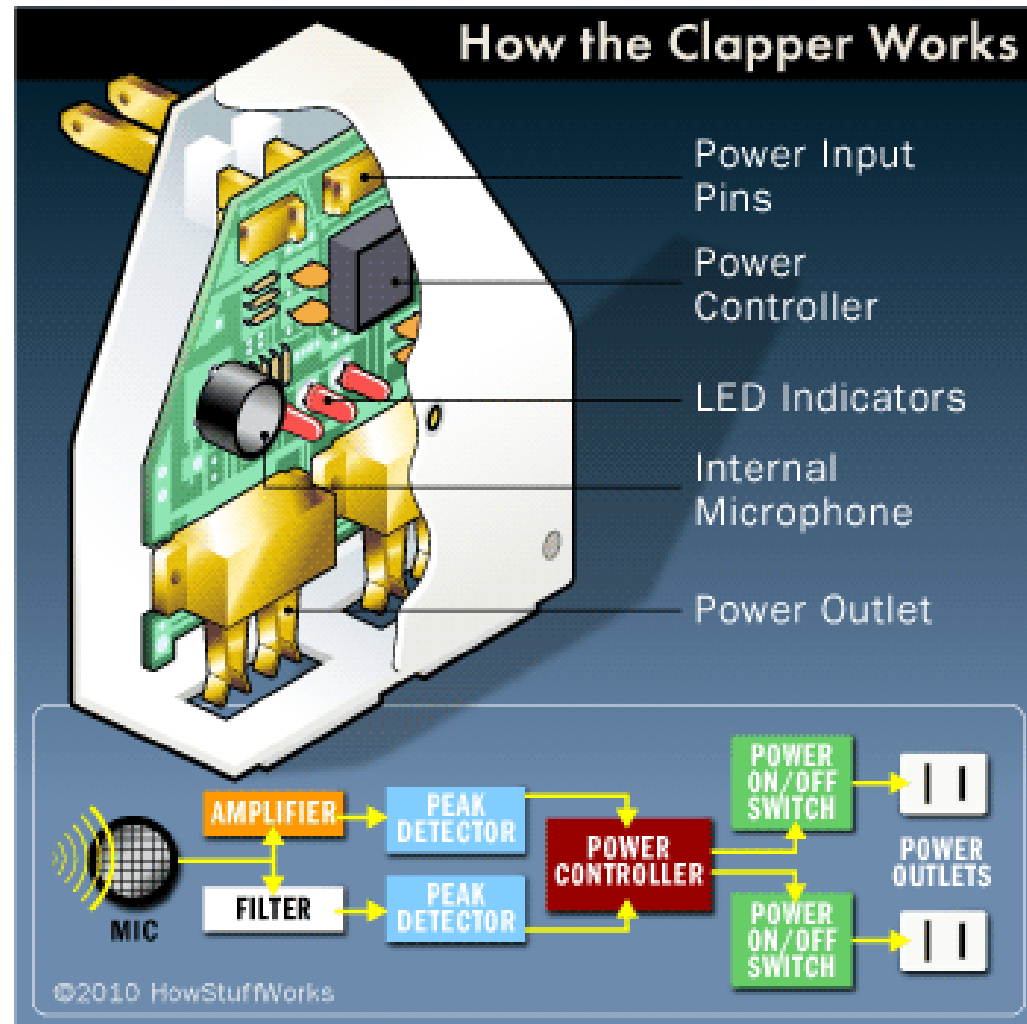

# Flexible Modelling Environment of Simulink

## Dynamic System

- Fixed/Variable Step ODE Solvers
- Discrete/Continuous, Mixed System
- Multi-rate System

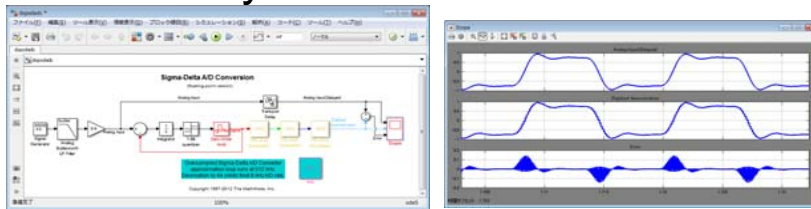

## Event-Driven System

- Nondeterministic Discrete System
- State Transition Diagram, Truth Table
- Flow Chart

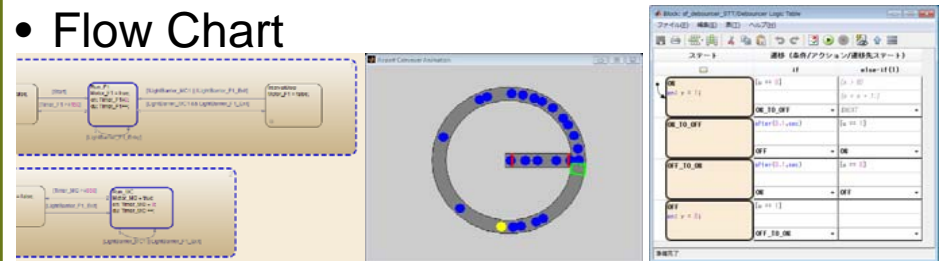

## Signal Processing / Communication System

- Digital Signal Processing System
- Communication System
- RF System

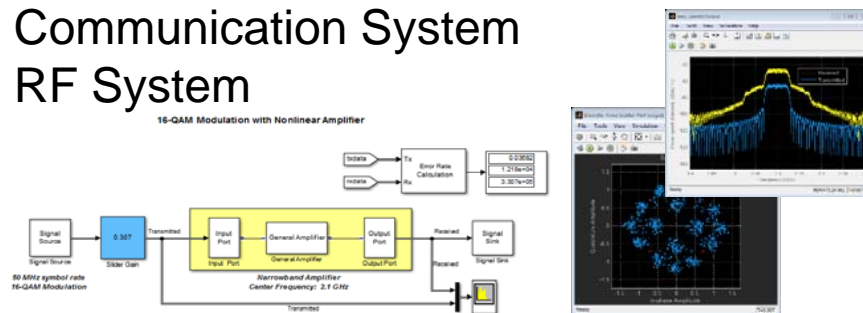

## Control Design / Physical System

- Linear Analysis (Time/Frequency Domain)
- Controller Tuning
- Multi-domain Physical Modelling

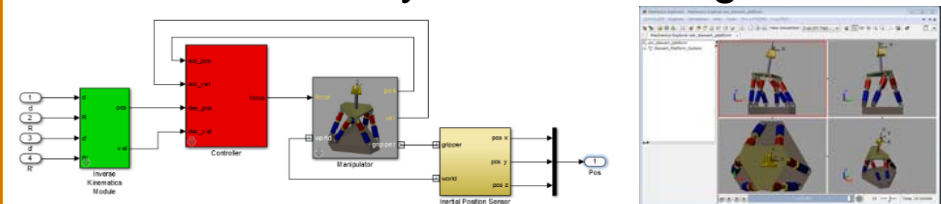



# Diverse needs met by Simulink

Automotive Control Development

Motor Control Design and Microcontroller Implementation

Remote Operation Robot Control Design

Precision Positioning

Mechanical and

System Analysis for Thermal Power

Coupled Analysis with In-house/Third-Party Simulators

Change in Blood Sugar Concentration During Insulin Medication  
Theory Practice Education for Students and Employees

Information Propagation Mechanisms Analysis of the Nervous System

A/D Converter Design

Noise Canceller Design

Design for Home Cooker

Printer Engine

FPGA Implementation

Software-Defined Radio Method Study

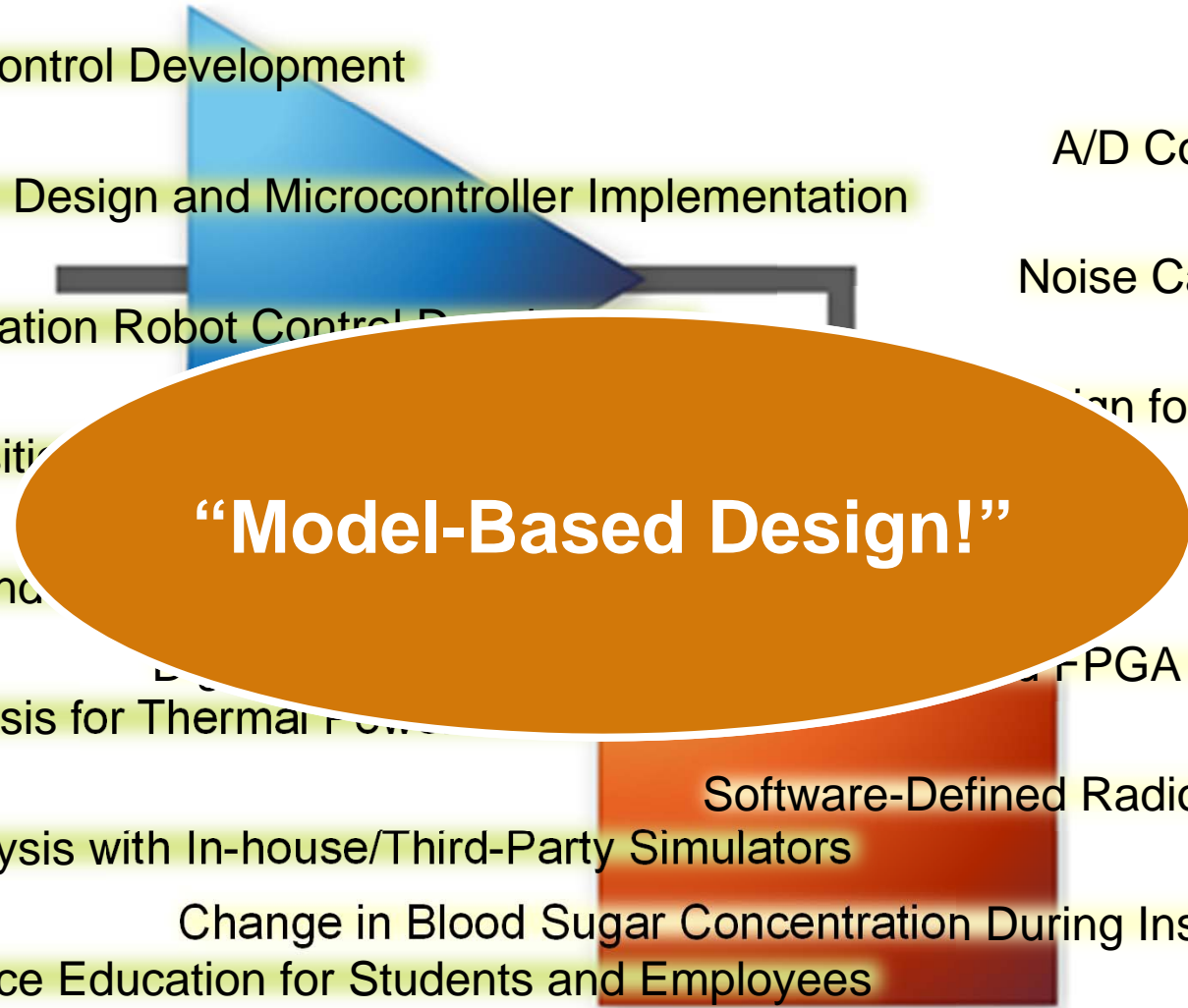

**“Model-Based Design!”**

# What is Simulink?

## A Platform for Model-Based Design

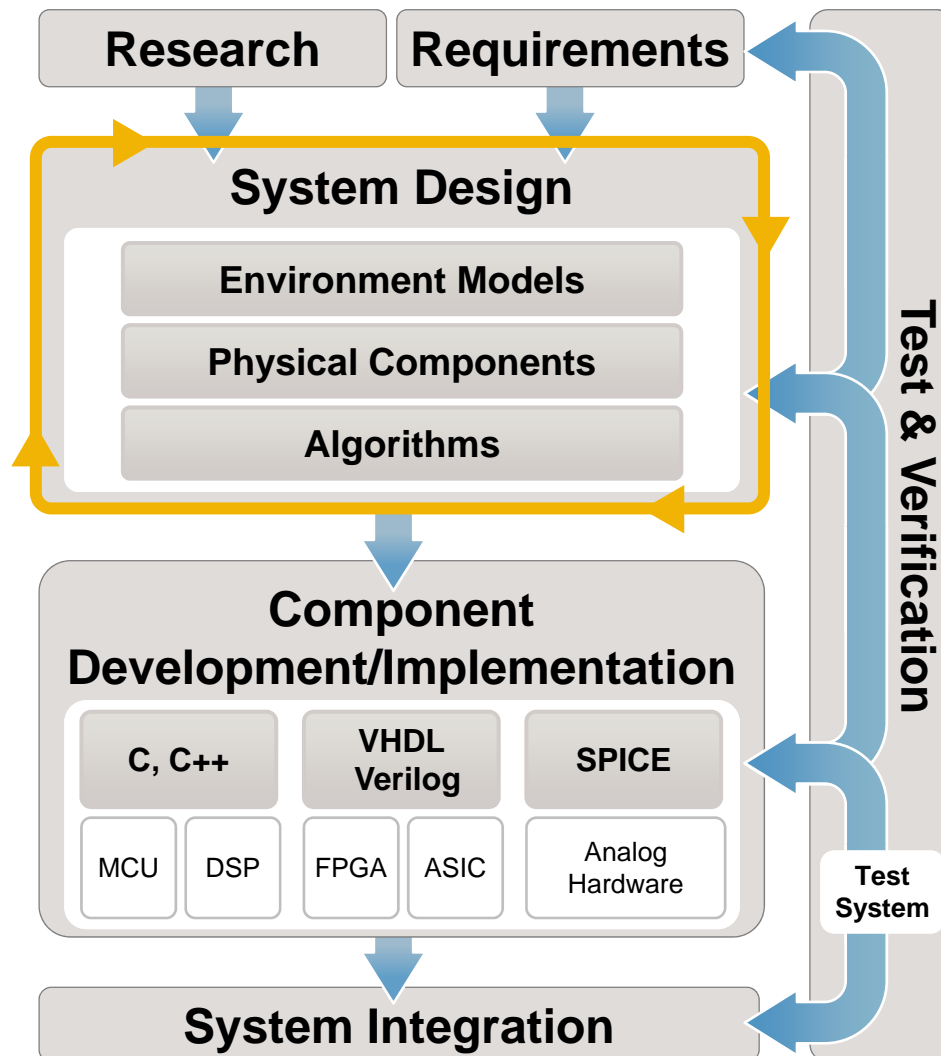

### Executable Specification

- Models that complement the paper based specifications
- Improve team communication

### Design by Simulations

- Modelling complex domains in the same environment.
- Trade-off and interaction verification

### Automatic Code Generation

- Automatic C / HDL code generation from Models
- Efficient prototype testing

### Continuous Testing / Verification

- Test generation by re-use of Models
- Simulation / test automation

# Demo: The Clapper (cont'd)

## What Happens After Modelling and Simulation?

**Automatic Code Generation**

**Exhaustive Logic Verification**

**Reusing Tests**

**Implementation of Generated Code**

**Reusing Tests**

**Code Generation Report**

```

98
99 /* Switch: '<S3>/Switch' incorporates:
100  * CombinatorialLogic: '<S13>/Logic'
101  * Constant: '<S3>/light_off!'
102  * Constant: '<S3>/light_on'
103  */
104 if (Clapper_ConstP.pooled6(uint32_T rowIdx) {
105     rtb_Switch = ON;
106 } else {
107     rtb_Switch = OFF;
108 }
109
110 % Switch: '<S3>/Switch' */
111

```

**Alternative ON/OFF Switch**

**How the Clapper Works**

- Power Input Pins
- Power Controller
- LED Indicators
- Internal Microphone
- Power Outlet

# What is Model-Based Design? A Development Flow Centered on the Executable Models

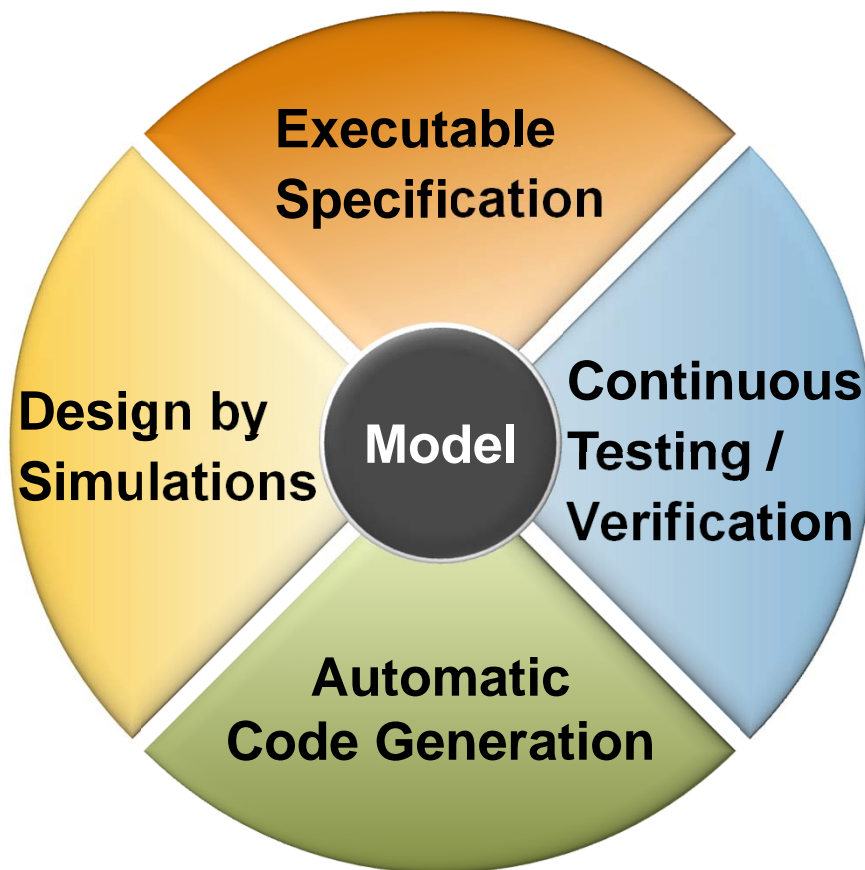

## Executable Specification

- Models that complement the paper based specifications
- Improve team communication

## Design by Simulations

- Modelling complex domains in the same environment.
- Trade-off and interaction verification

## Automatic Code Generation

- Automatic C / HDL code generation from Models
- Efficient prototype testing

## Continuous Testing / Verification

- Test generation by re-use of Models
- Simulation / test automation

## By Now You Should Know...

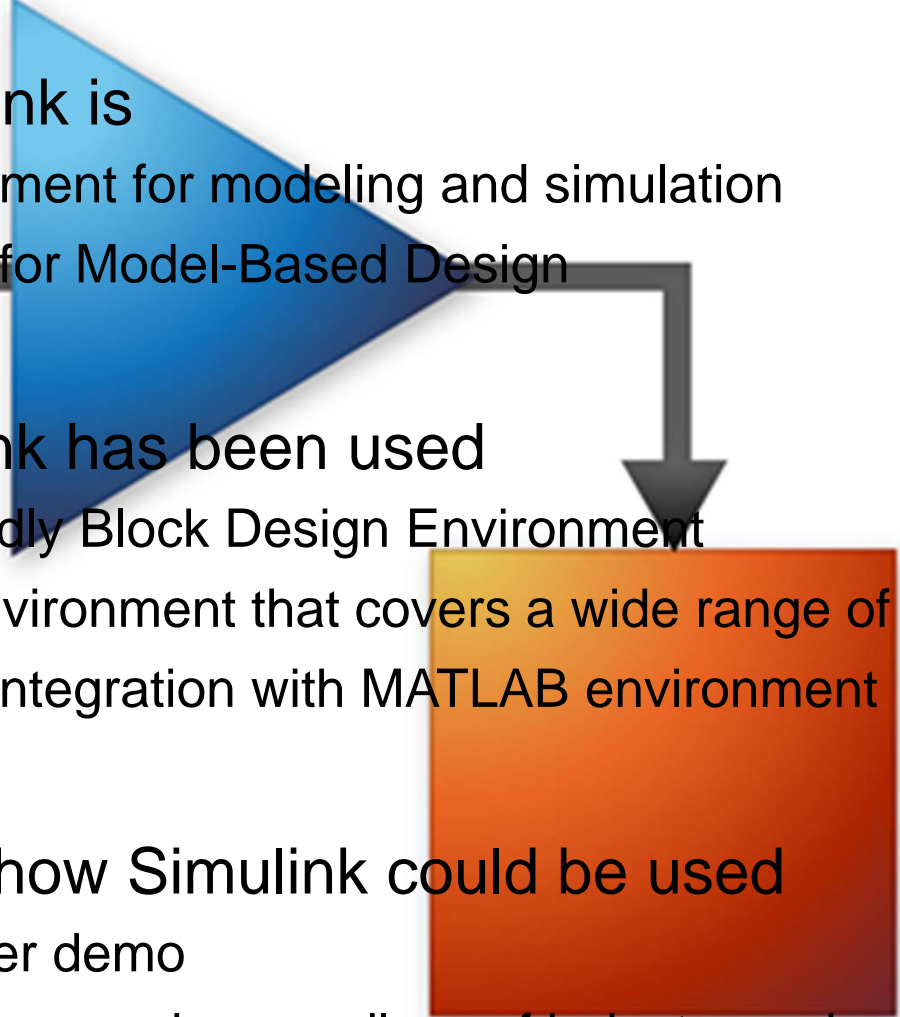
- What Simulink is
    - An environment for modeling and simulation
    - A platform for Model-Based Design
  - Why Simulink has been used
    - User-Friendly Block Design Environment
    - Flexible environment that covers a wide range of application areas
    - Complete integration with MATLAB environment
  - Where and how Simulink could be used
    - The Clapper demo
    - Meet diverse needs regardless of industry and application
- 

## Related Information

- Useful Resources
  - [Model Examples](#)
  - [User Stories](#)
  - [User Community](#)
- Event Information
  - [Webinars, Seminars and Conferences](#)
- Services
  - [Technical Support](#)
  - [Training Services](#)
  - [Consulting Services](#)
- Free Product Trials
  - [Get Trial Software](#)



© 2015 The MathWorks, Inc. MATLAB and Simulink are registered trademarks of The MathWorks, Inc. See [www.mathworks.com/trademarks](http://www.mathworks.com/trademarks) for a list of additional trademarks. Other product or brand names may be trademarks or registered trademarks of their respective holders.