

MathWorks
MATLAB
CONFERENCE 2018

Predictive Maintenance
From Development to IoT Deployment

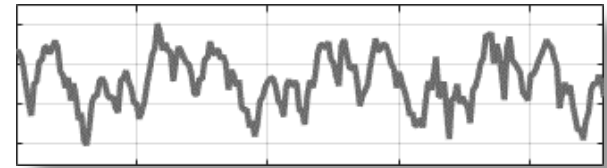

What is Predictive Maintenance?

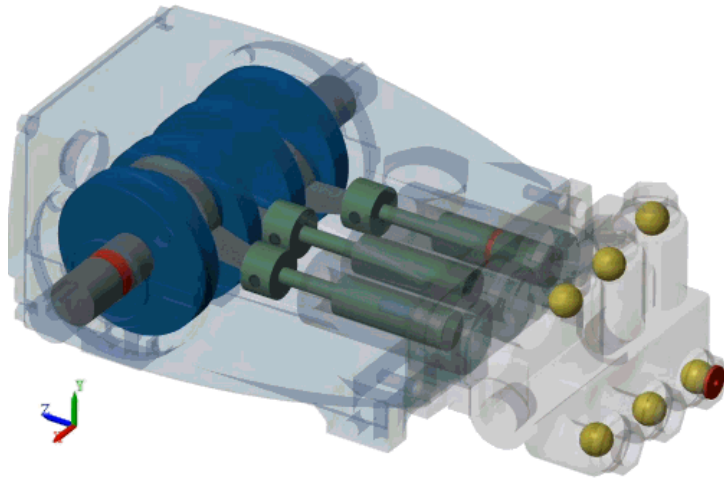



English Spanish French Pump - detected ▼



English Russian Greek ▼

Translate

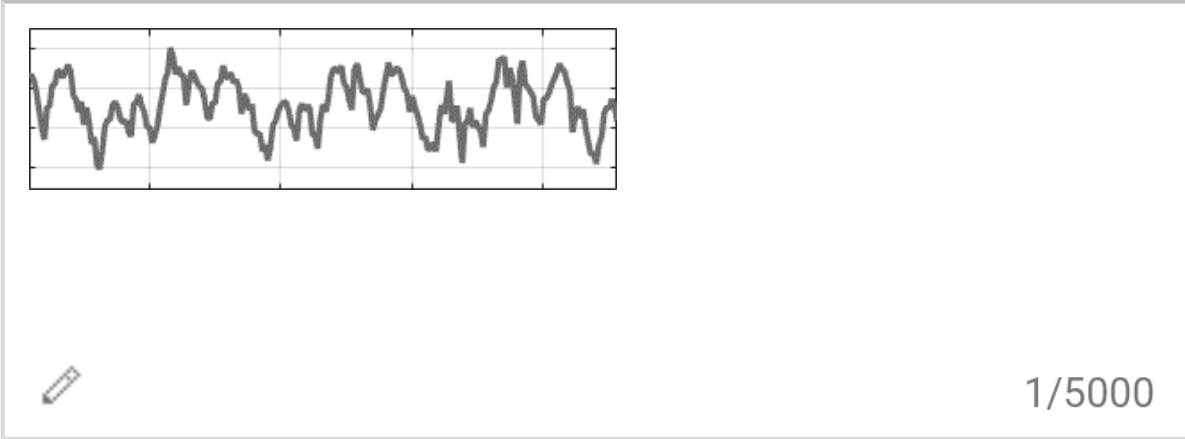

I need help.



English Spanish French Pump - detected ▼



English Russian Greek ▼

Translate

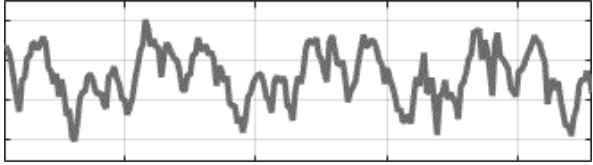

1/5000

I need help. One of my cylinders is blocked. I will shut down your line in 15 hours



What do you expect from predictive maintenance?

- Maintenance cares about day-to-day operations
 - Reduced downtime
- Operations & IT look at the bigger picture
 - Improved operating efficiency
- Engineering groups get product feedback
 - Better customer experience
- Upper management wants to drive growth
 - New revenue streams

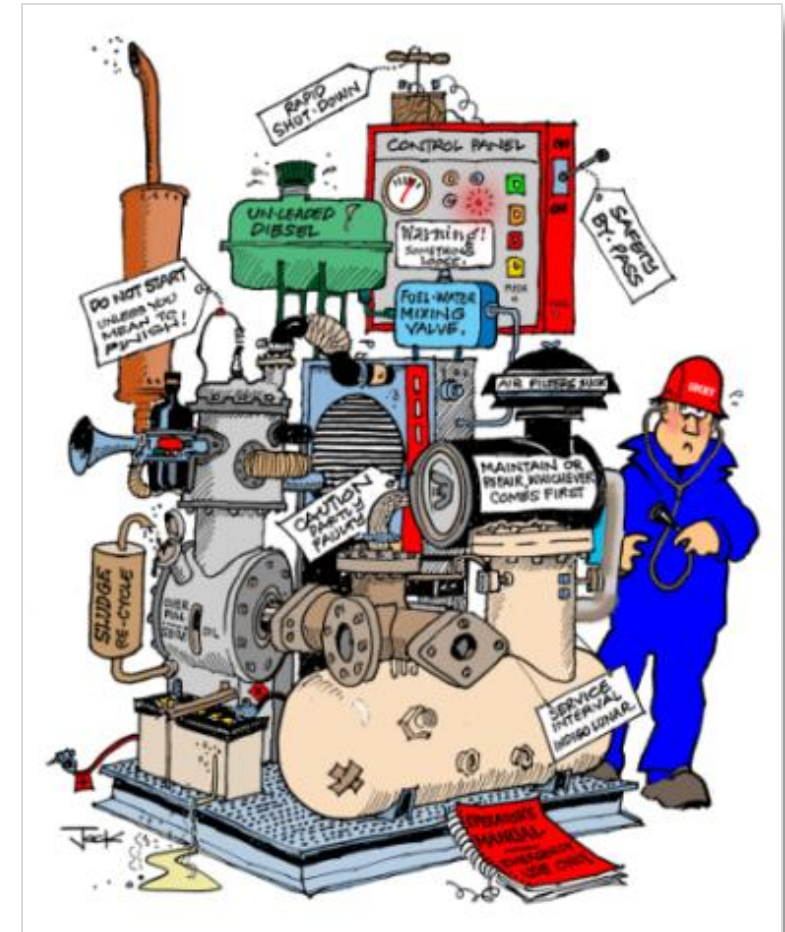

Source: Tensor Systems





Industrial Internet of Things

Google search results for "iiot". Navigation tabs: All, News, **Images**, Videos, Books, More. Settings, Tools. View saved, SafeSearch.

- production
- industrial iot
- iiot industrial
- things iiot
- industrial internet

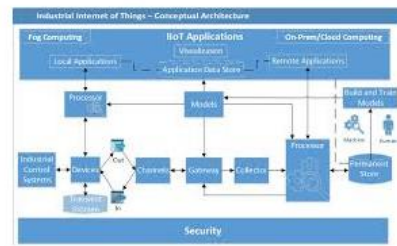
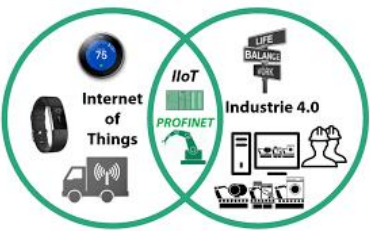
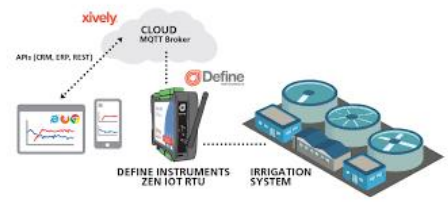
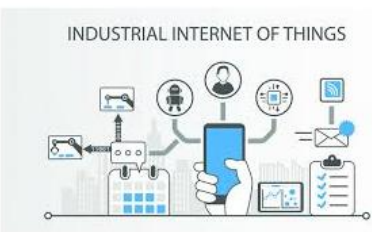
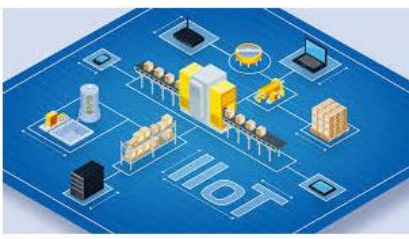
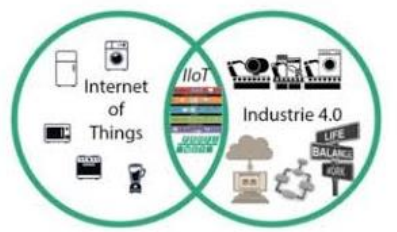
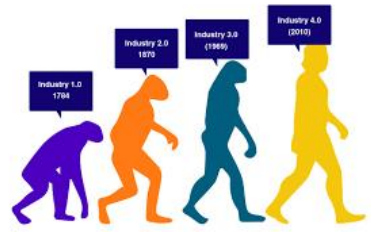
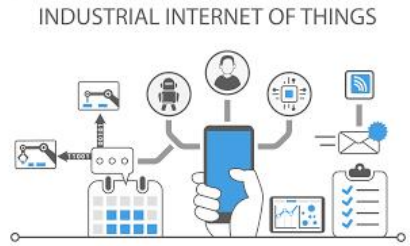
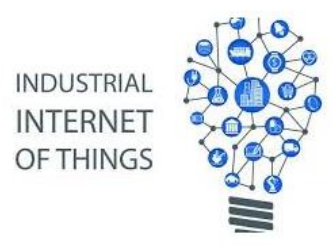

Industrial Internet of Things

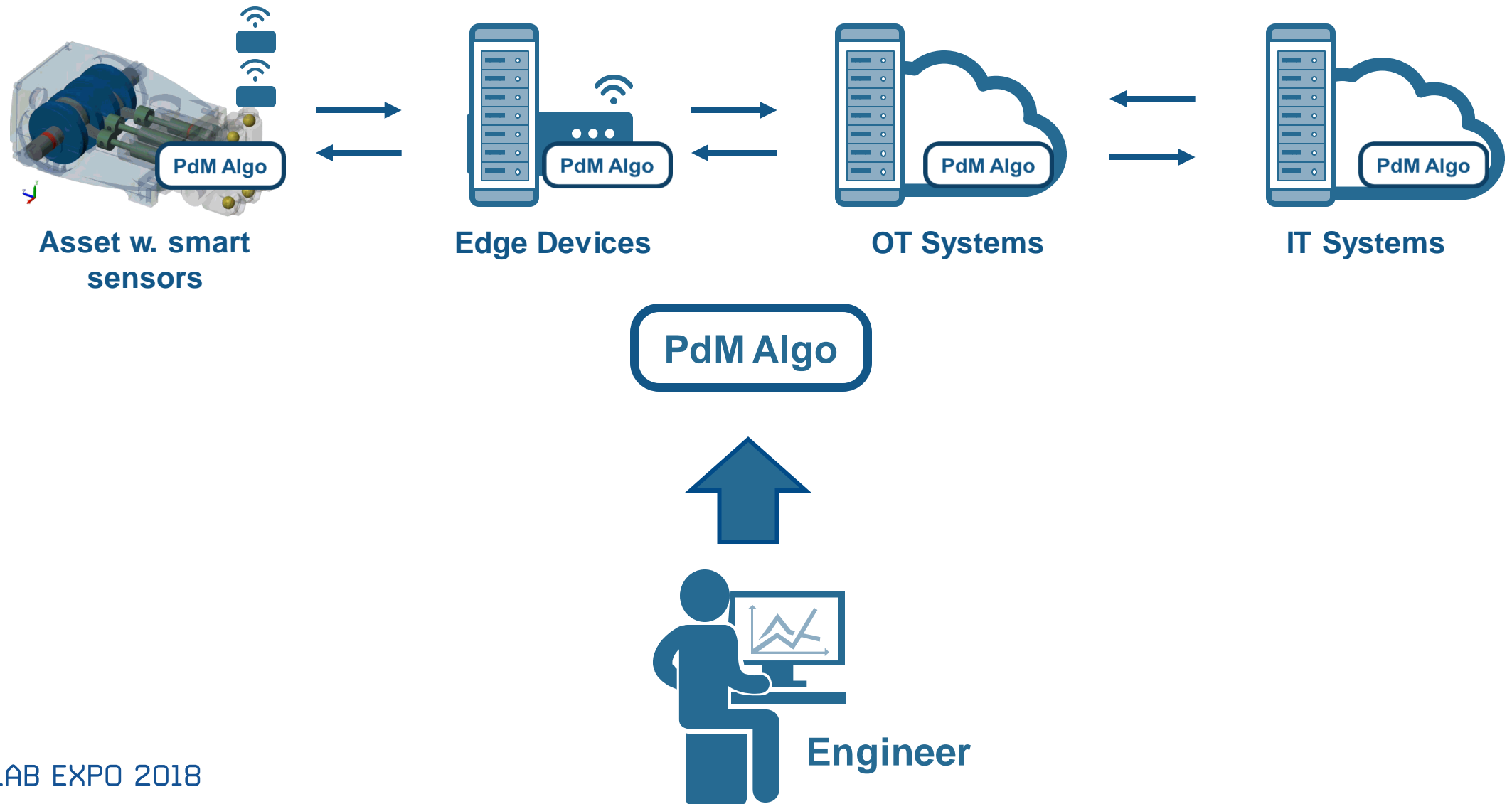

Why MATLAB & Simulink for Predictive Maintenance

- Get started quickly
- Reduce the amount of data you need to store and transmit
- Deliver the results of your analytics based on your audience
- Create training data for your algorithm in the absence of real failure data

Challenges: How much data are you collecting?

- 1 day ~ 1.3 GB
- 20 sensors/pump ~26 GB/day
- 3 pumps ~ 78 GB/day
- Satellite transmission
 - Speeds approx. 128-150 kbps,
 - Cost \$1,000/ 10GB of data
- Needle in a haystack problem

Pump flow sensor 1 sec ~ 1000 samples ~16kB

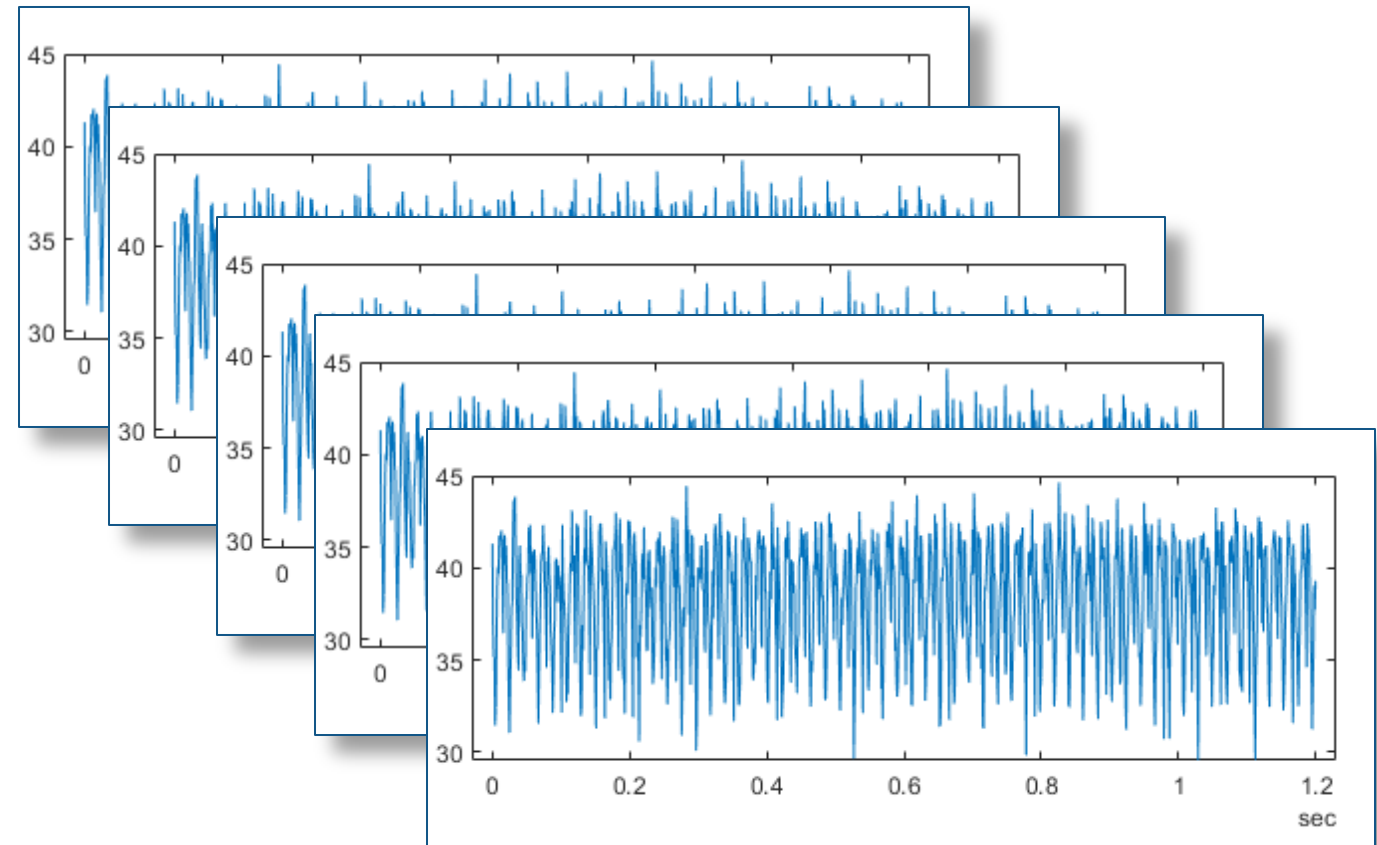

Solution: Feature extraction at the Edge

- How do you extract features?
- Which features should you extract?
- How do I deal with streaming data?

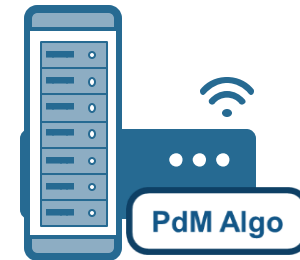
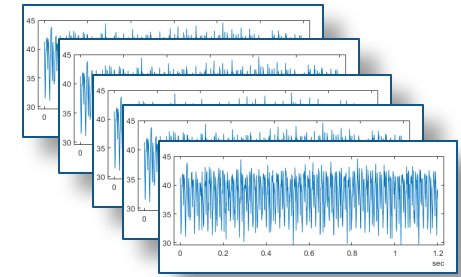

Edge Devices



qMean	qVar	qSkewness	qKurtosis
38.4945	9.2306	-0.5728	2.4662
qPeak2P...	qCrest	qRMS	qMAD
15.2351	1.1553	38.6141	2.5562

HOME PLOTS APPS LIVE EDITOR INSERT VIEW

CleanUp

Search Documentation Log In

New Open Save Find Files Compare Go To Find

Print

FILE NAVIGATE TEXT CODE SECTION RUN

Text Aa Normal B I U M

Code

Section Break

Run Section Run and Advance Run to End

Run Step Stop

C:\Users\abaru\Desktop\Expo 2018\FinalDemo\Demo_Files\Data_Reduction

Current Folder Live Editor - C:\Users\abaru\Desktop\Expo 2018\FinalDemo\Demo_Files\Data_Reduction\Expo_Data_Preprocessing_CodeGen.mlx

Name

Data

- pdmRecipPump_log_1.mat
- pdmRecipPump_log_2.mat
- pdmRecipPump_log_3.mat
- pdmRecipPump_log_4.mat
- pdmRecipPump_log_5.mat
- pdmRecipPump_log_6.mat
- pdmRecipPump_log_7.mat
- pdmRecipPump_log_8.mat
- pdmRecipPump_log_9.mat
- pdmRecipPump_log_10.mat
- pdmRecipPump_log_11.mat
- pdmRecipPump_log_12.mat
- pdmRecipPump_log_13.mat**
- pdmRecipPump_log_14.mat
- pdmRecipPump_log_15.mat
- pdmRecipPump_log_16.mat
- pdmRecipPump_log_17.mat
- pdmRecipPump_log_18.mat
- pdmRecipPump_log_19.mat
- pdmRecipPump_log_20.mat
- pdmRecipPump_log_21.mat
- pdmRecipPump_log_22.mat
- pdmRecipPump_log_23.mat

pdmRecipPump_log_13.mat (MAT-file)

Expo_Data_Preprocessing_CodeGen.mlx featureExtractionBuffer.m

Algorithm Development for Feature Extraction at the Edge

Processing and Extracting Features from the Simulation Results

The model is configured to log the pump output pressure, output flow, motor speed and motor current.

```
1 ens = simulationEnsembleDatastore('.\Data');
2 ens.SelectedVariables = ["qOut_meas", "SimulationInput"];
3 reset(ens)
4 data = read(ens);
5 [flow,time_unit] = preprocess(data);
6 figure;
7 plot(flow.Time,flow.Data);

8 % Decide which features to extract
9
10 ens.DataVariables = [ens.DataVariables; ...
11     "qMean"; "qVar"; "qSkewness"; "qKurtosis"; ...
12     "qPeak2Peak"; "qCrest"; "qRMS"; "qMAD"; "qCSRRange"];
13 ens.ConditionVariables = ["Time_Unit"];
14
15 feat = extractCI(flow);
16 dataToWrite = [time_unit, feat];
17 writeToLastMemberRead(ens,dataToWrite{:})
```

Solution: Feature extraction at the Edge

- How do you extract features?
 - Signal processing methods
 - Statistics & model-based methods

- Which features should you extract?
 - Depends on the data available
 - Depends on the hardware available

- How do I deal with streaming data?
 - Determine buffer size
 - Extract features over a moving buffer window

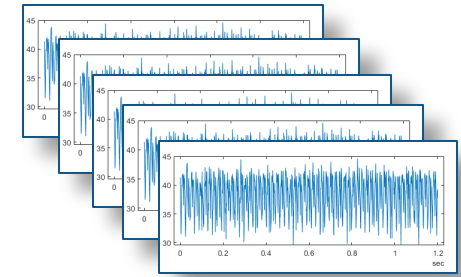

Edge Devices



qMean	qVar	qSkewness	qKurtosis
38.4945	9.2306	-0.5728	2.4662
qPeak2P...	qCrest	qRMS	qMAD
15.2351	1.1553	38.6141	2.5562

Challenges: What do your end users expect?

- Maintenance needs simple, quick information
 - Hand held devices, Alarms
- Operations needs a birds-eye view
 - Integration with IT & OT systems
- Customers expect easy to digest information
 - Automated reports

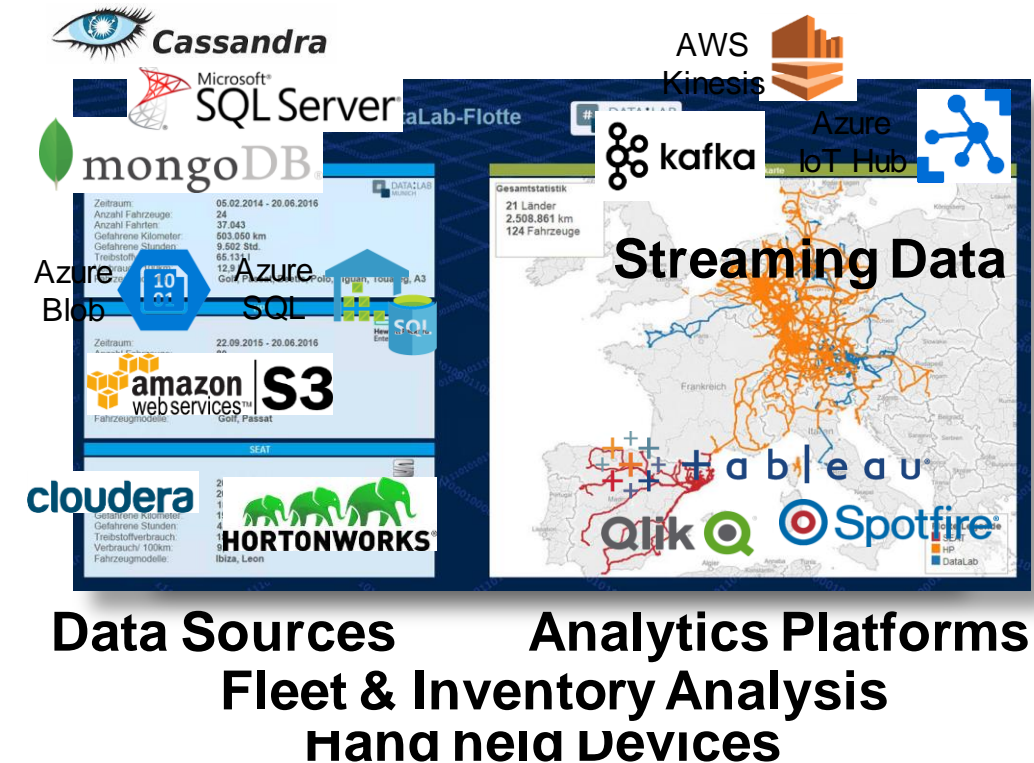

Solution: Flexible deployment of algorithms

- Can I reuse my algorithm code for deployment?
- How do I update my predictive model?
- How do I integrate with my IT/OT systems?

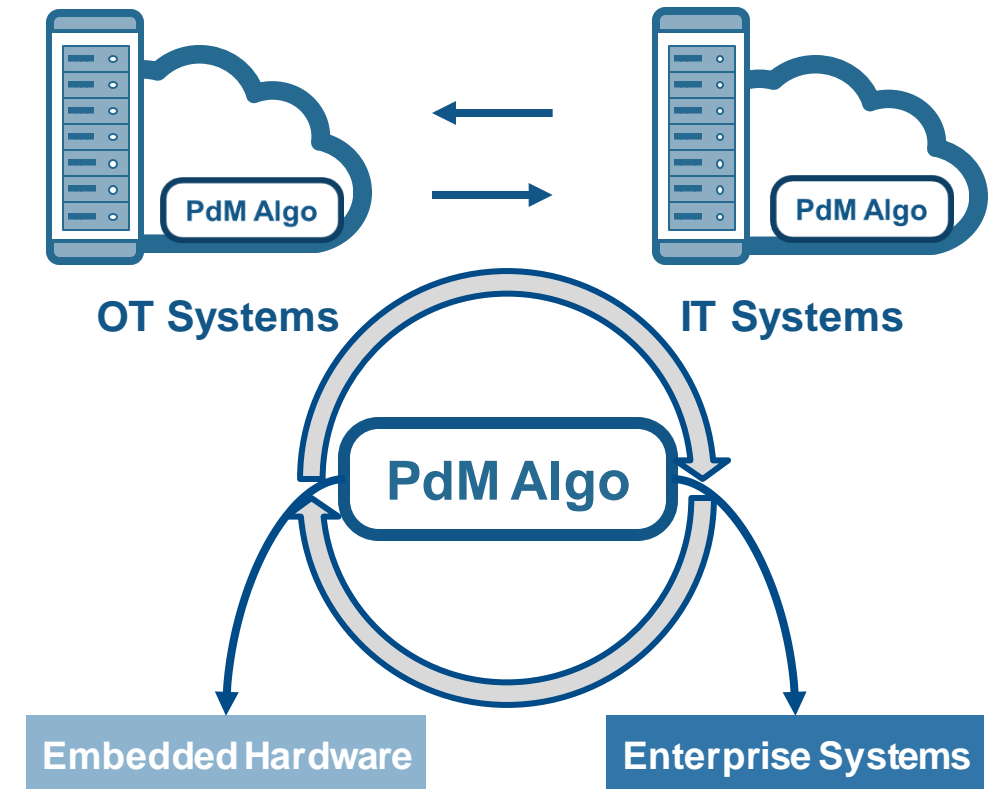

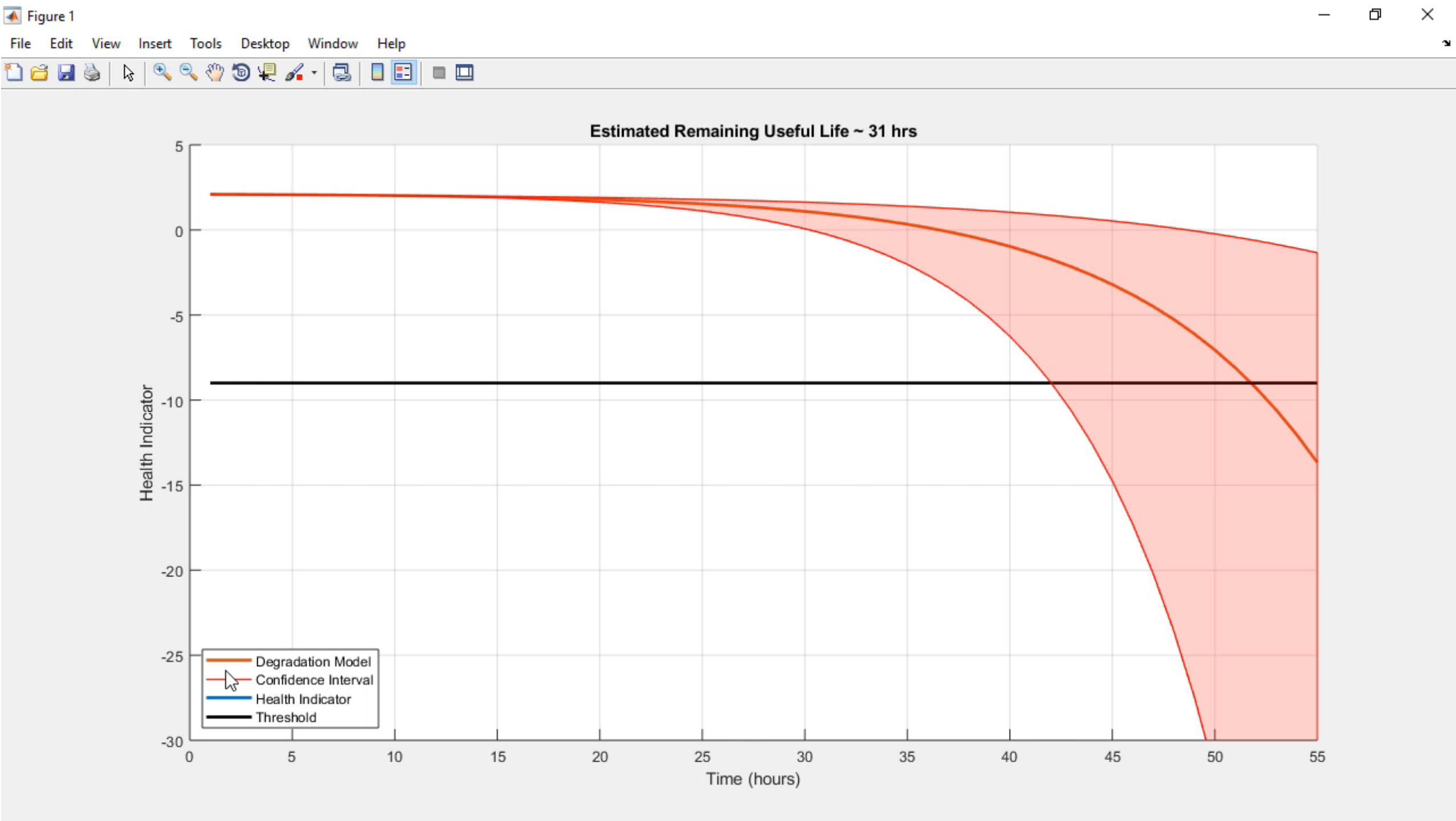

Solution: Flexible deployment of algorithms

- Can I reuse my algorithm code for deployment?
 - Code generation at the Edge
 - Libraries & executables for IT/OT systems
- How do I update my predictive model?
 - Retrain degradation models for RUL estimation
 - Retrain classification models for fault isolation
- How do I integrate with my IT/OT systems?
 - Connect to data sources & scale computations
 - Connect to dashboards & analytics platforms

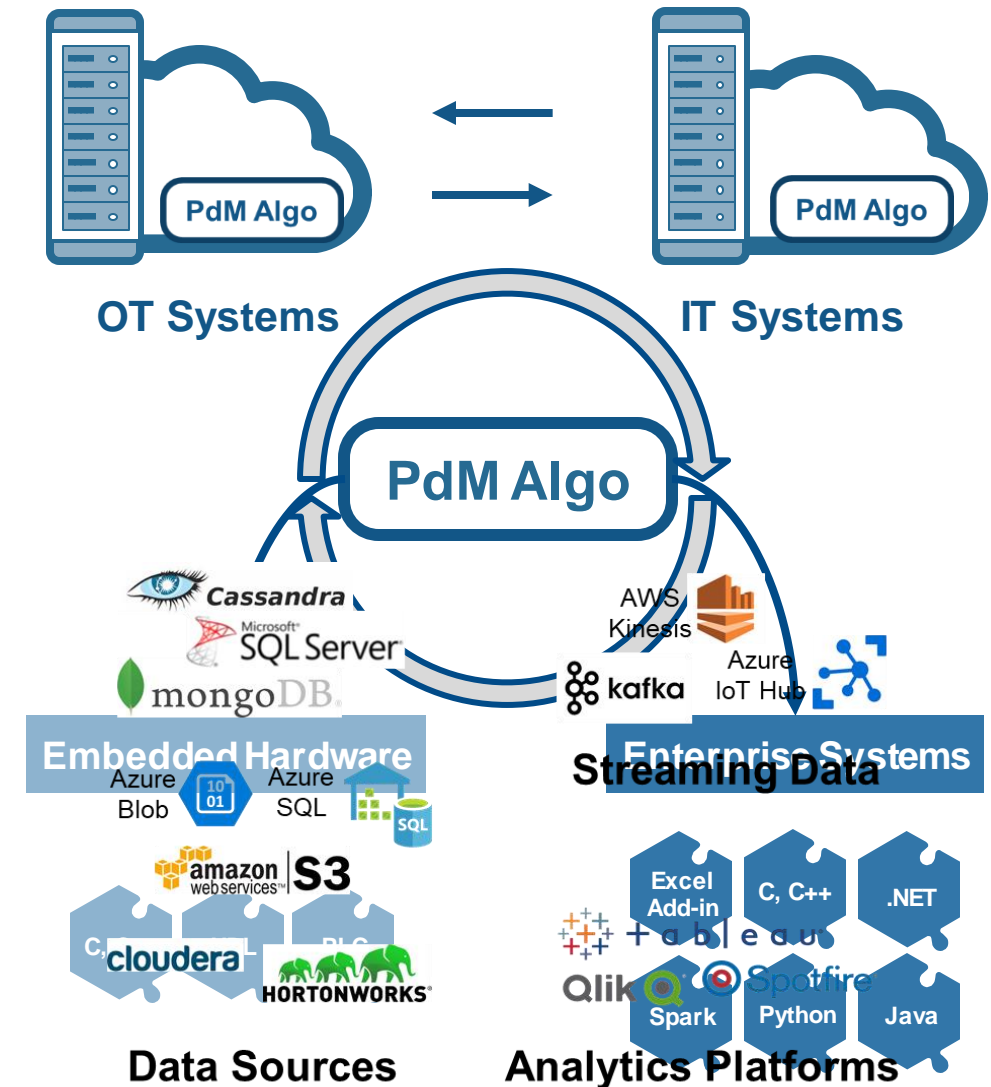

Challenges: What if you don't have the data you need?

- Lack of labelled failure data
- Multiple failure modes and failure combinations possible
- Different machines can show different behavior for the same failure

Solution: Generating failure data from Simulink models

- How do I model failure modes?
- How do I customize a generic model to a specific machine?
- How do I know if the data is accurate?

File Explorer Simulation View Tools Help

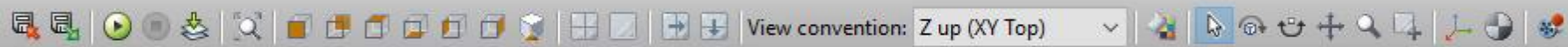

MENU AND TOOLBARS

Mechanics Explorers - Mechanics Explorer-sm_pump_triplex

Mechanics Explorer-sm_pump_triplex

- sm_pump_triplex
 - Driver
 - Pump
 - Connection Frames

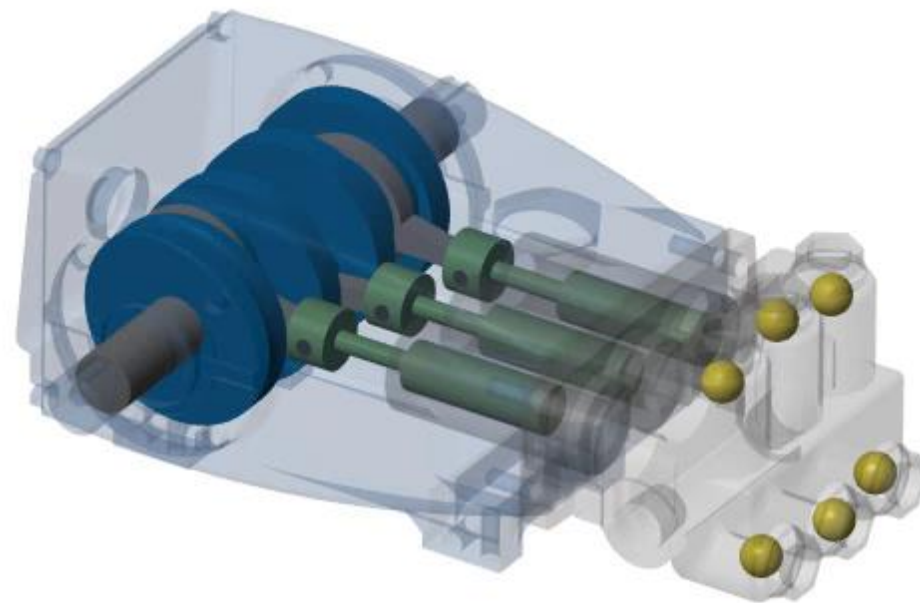

T = [0,1.5]

1/8X

Time 1.5

Command Window

fx >>

Solution: Generating failure data from Simulink models

- How do I model failure modes?
 - Work with domain experts and the data available
 - Vary model parameters or components
- How do I customize a generic model to a specific machine?
 - Fine tune models based on real data
 - Validate performance of tuned model
- How do I know if the data is accurate?

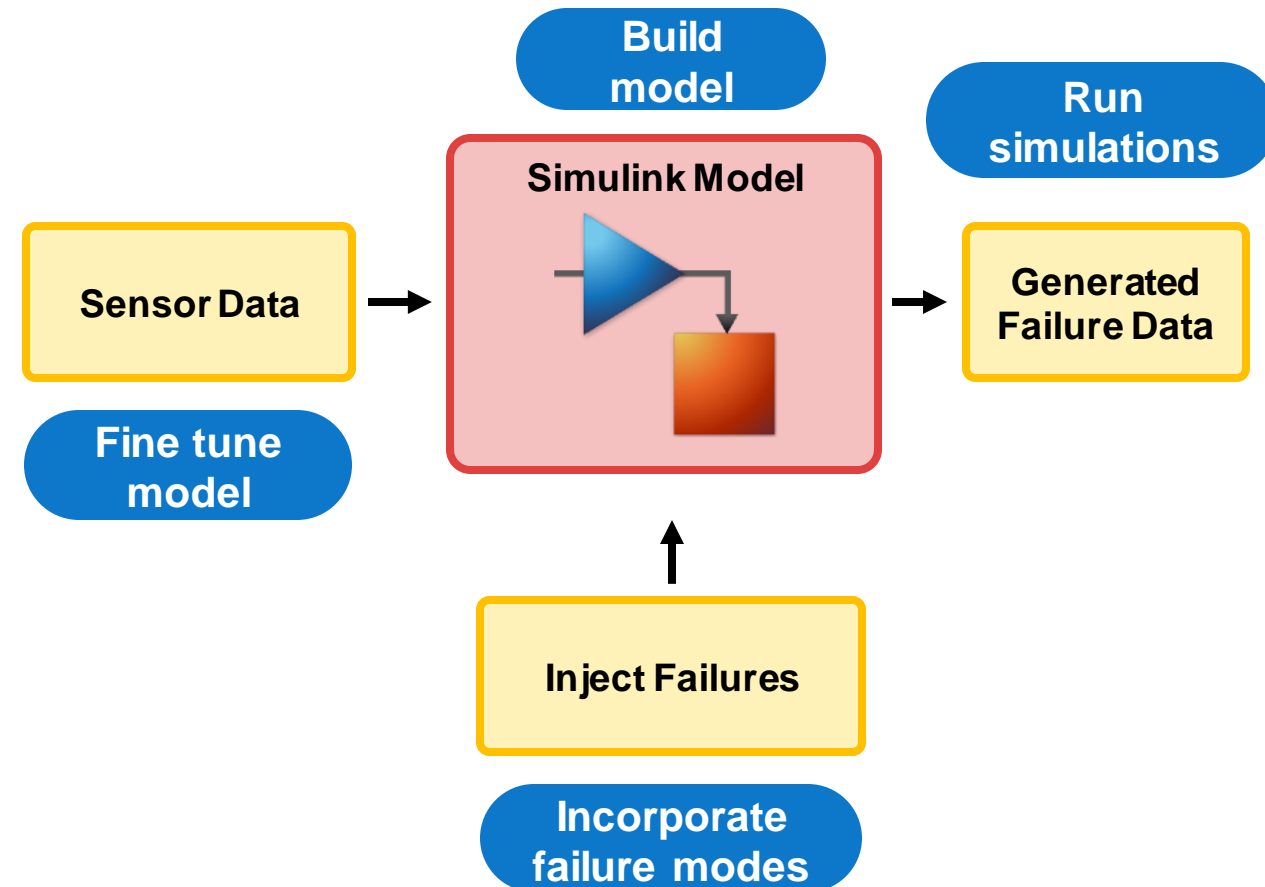

Solution: Generating failure data from Simulink models

- How do I know if failure data is accurate?
 - Work with experts
 - Available
 - Vary
- How do I know if the data is accurate?

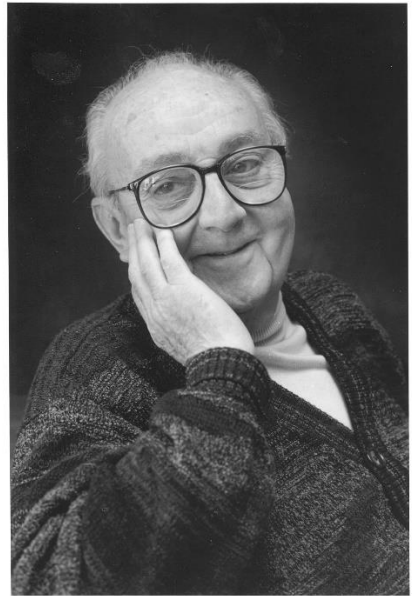

“Essentially, all models are wrong,
but some are useful”

George E.P. Box

Inject Failures

3. Incorporate
failure modes

4. Run
simulations

Generated
Failure Data

Why MATLAB & Simulink for Predictive Maintenance

- Get started quickly
- Reduce the amount of data you need to store and transmit
- Deliver the results of your analytics based on your audience
- Create training data for your algorithm in the absence of real failure data