

Using MATLAB/Simulink on Mars*

*+/- 401 million km

William Reid

May 24, 2016

MATLAB Conference Sydney

The Museum of Applied Arts and Sciences, Sydney



THE UNIVERSITY OF
SYDNEY

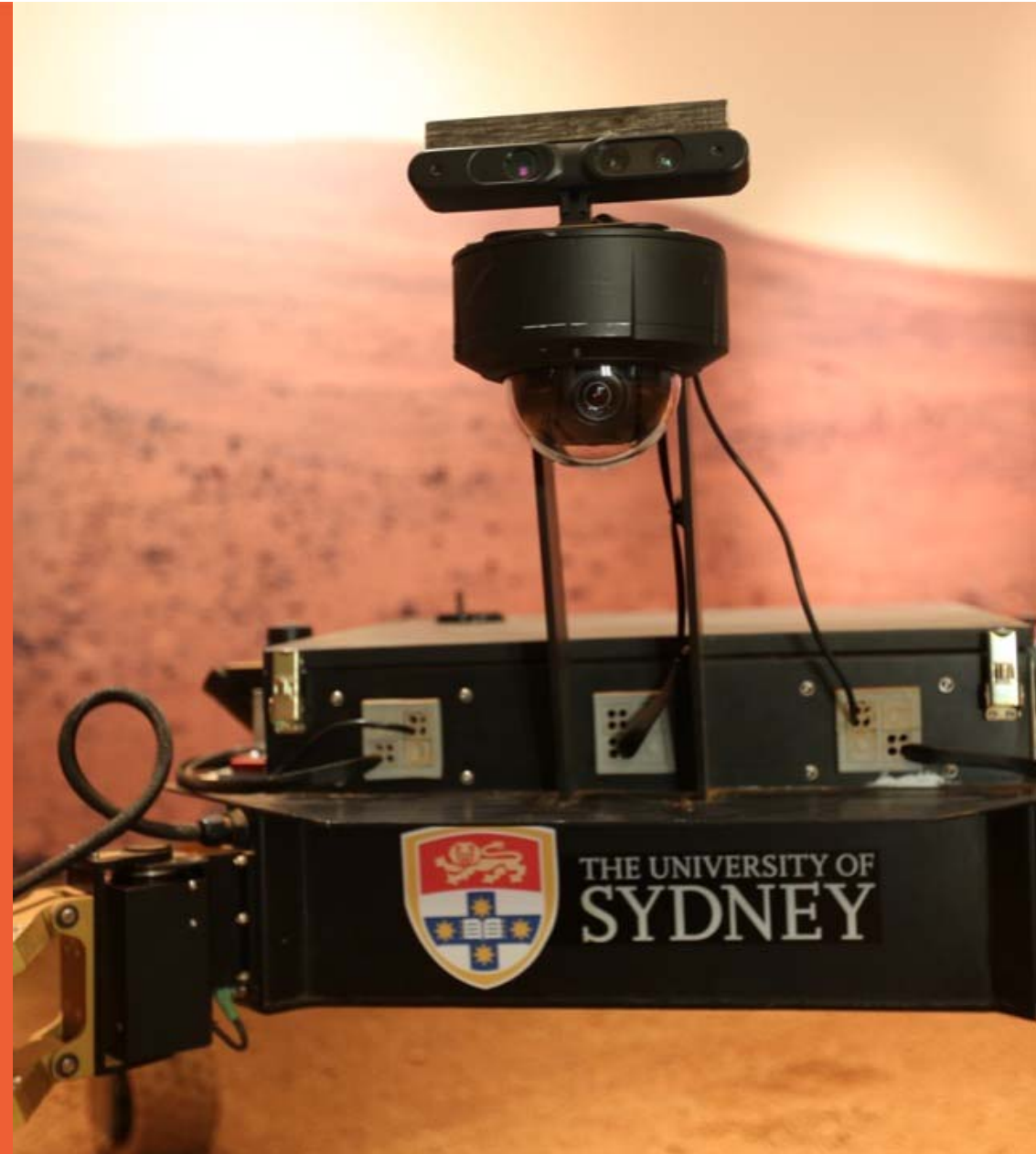

Introduction/Outline



- Engineer/Educator/Space Enthusiast
- The Mars Lab
- The MAMMOTH Rover
- MATLAB/Simulink
- MAMMOTH Software
- Other MAMMOTH adventures

Schools



THE UNIVERSITY OF
SYDNEY



UNSW
THE UNIVERSITY OF NEW SOUTH WALES
SYDNEY • AUSTRALIA

AA Applied Arts
& Sciences **AS**



Australian Government

Department of Education and Training



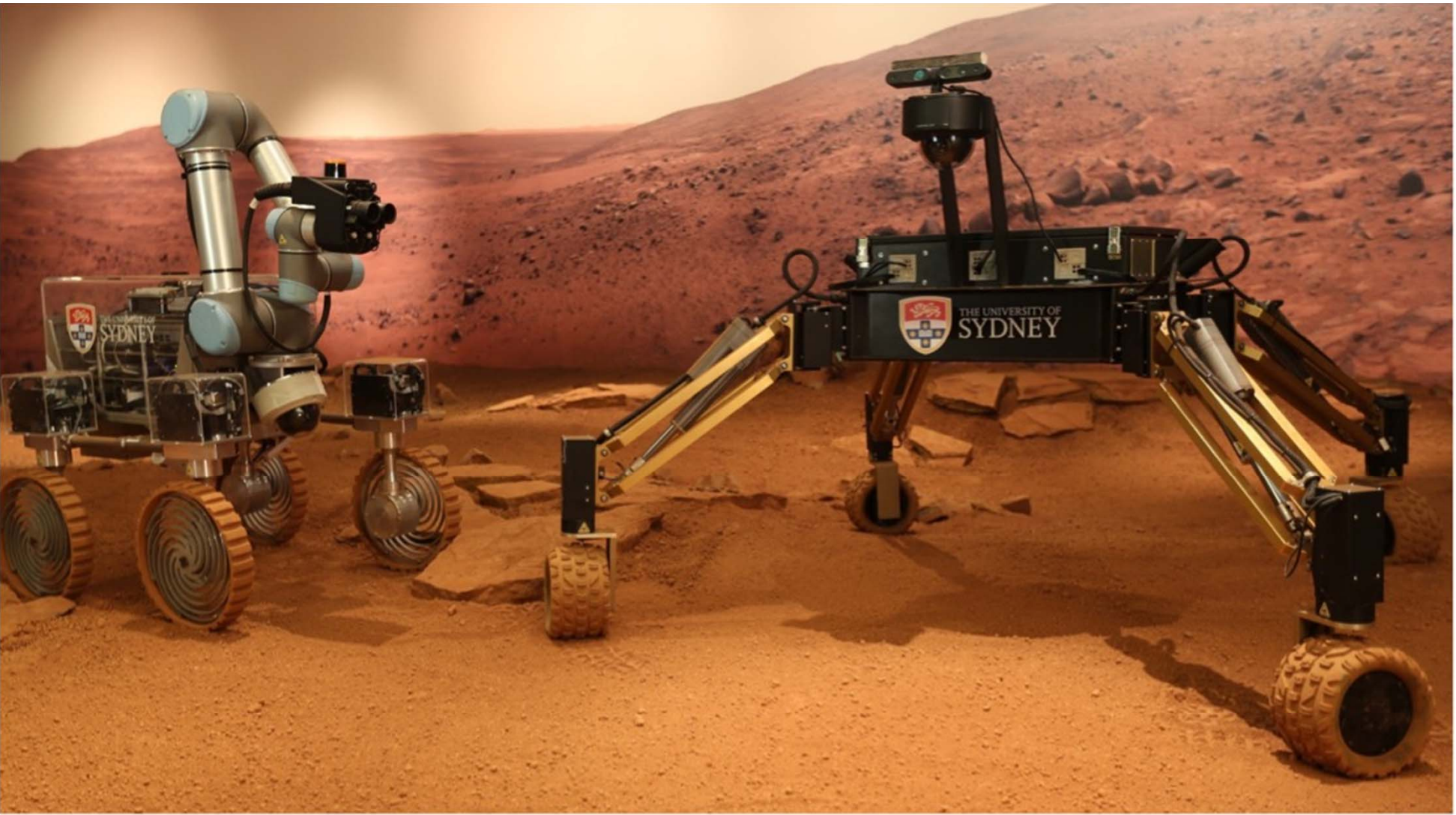

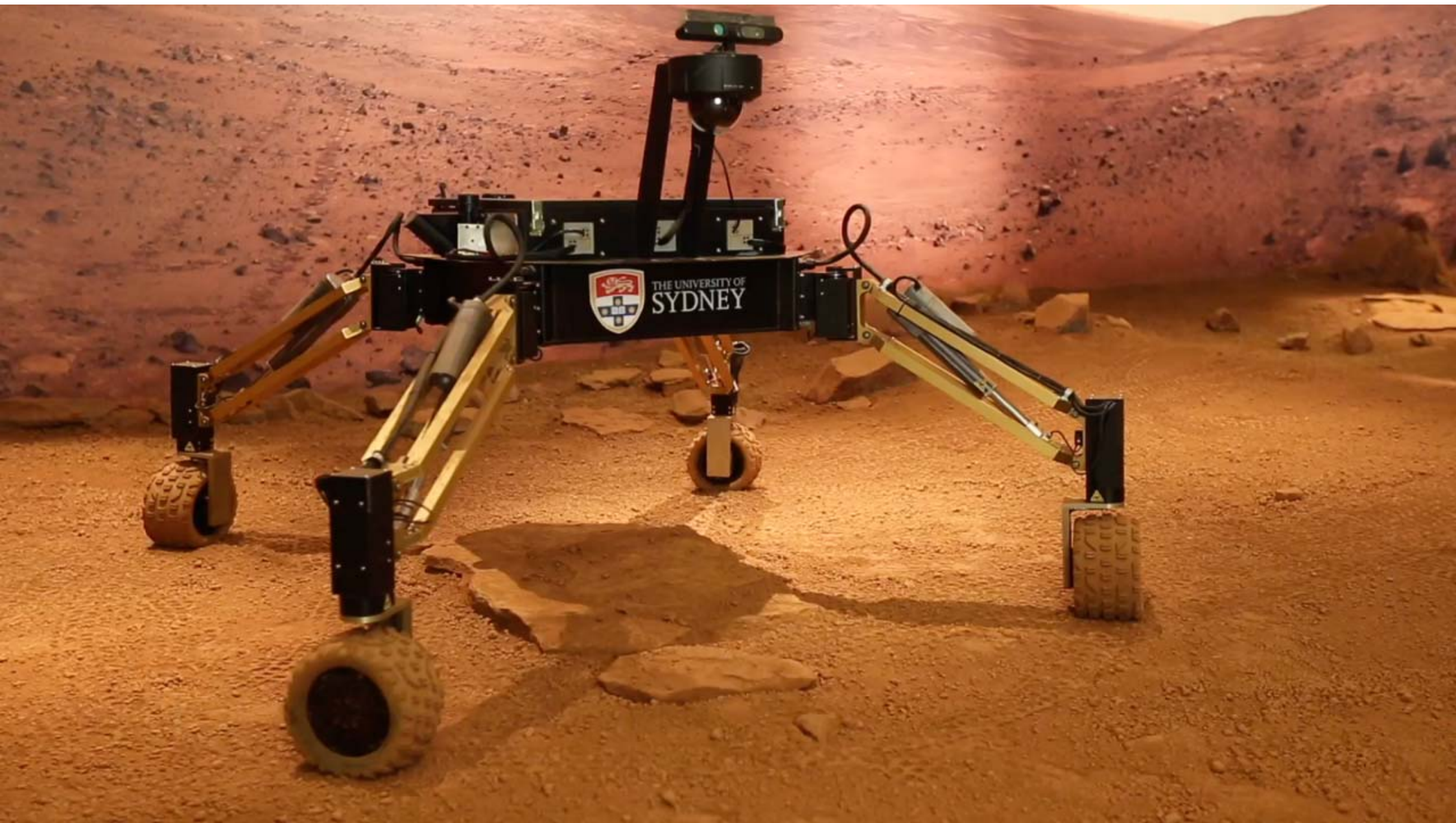

The MAMMOTH Rover

12 x 97 Wh
Li-Ion Batteries

RGB-D Sensor
(Not shown)

Vision/IMU Fused
Localization

Front and Side
Haz Cams

4 x 1.5 kN
Linear Actuators

Abs. Encoders
for each
actuator

12 x 100 W
Rotary
Actuators

4 x Leg
Force
Sensors

Mass = 75 kg
Max Footprint: 1800 mm x 1800 mm
Min Footprint: 650 mm x 650 mm
Max Flat Plane Clearance: 800 mm

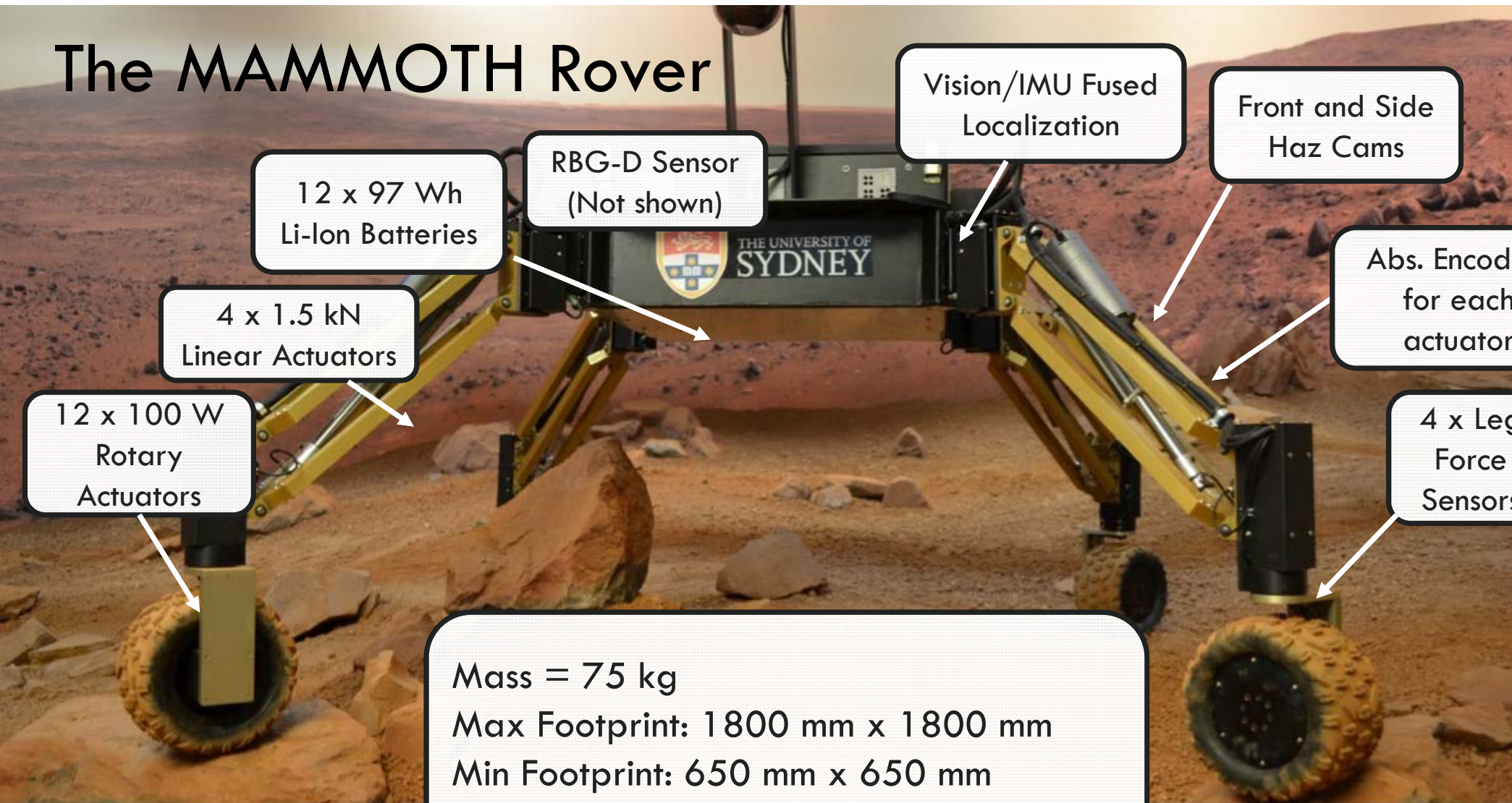

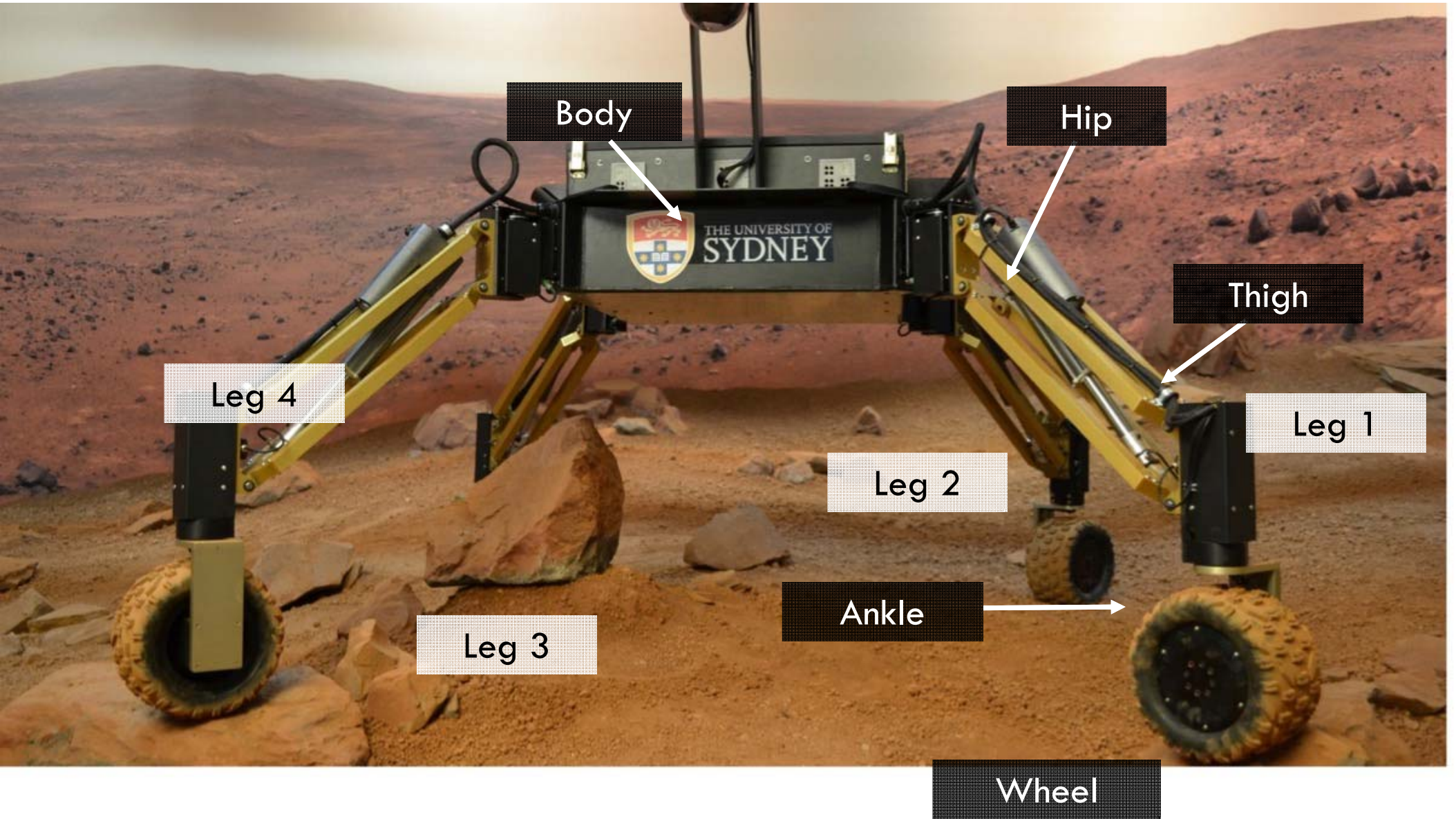

Body

Hip

Thigh

Leg 4

Leg 1

Leg 2

Leg 3

Ankle

Wheel

MATLAB/Simulink Software Development

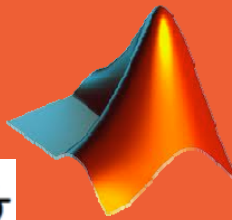

Algorithmic Development

$$\underline{v}_C^W = B(\underline{p})\underline{V} + Q(\underline{\gamma})\dot{\underline{\gamma}} + \dot{\underline{\sigma}}$$

$$\dot{\underline{\zeta}} = (S_{Q_\zeta} Q_\zeta)^\# (\underline{v}_{C,z}^W - [S_B B \quad S_Q Q_\epsilon] \dot{\underline{\eta}})$$

Software-In-The-Loop

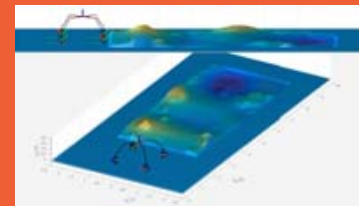

Hardware-In-The-Loop



C++ Generation for
Deployment

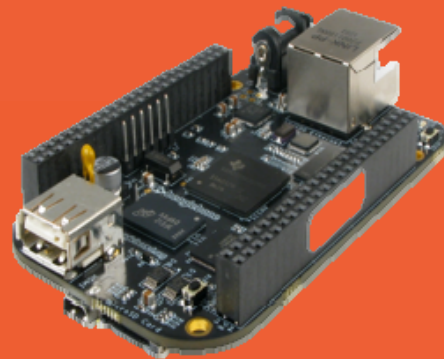

THE UNIVERSITY OF
SYDNEY



Actively Articulated Suspension – Algorithmic Development

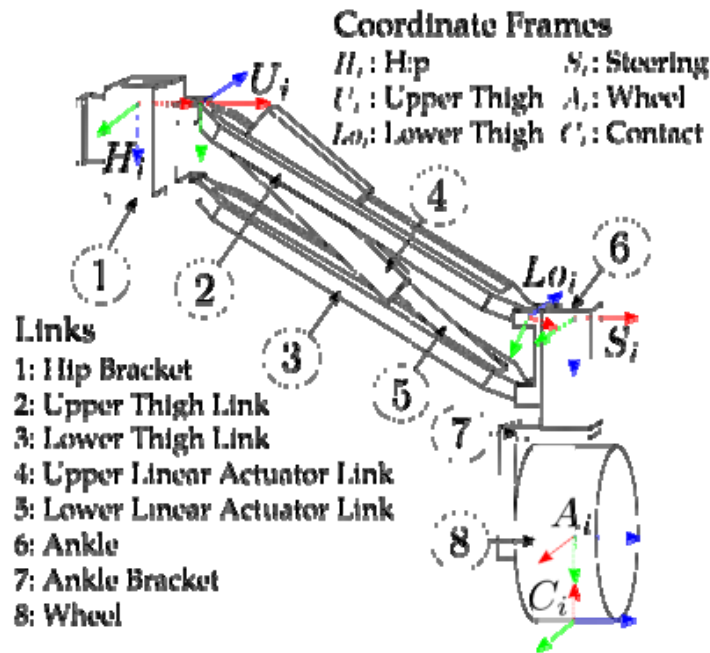

Body pose vector:

$$\underline{p} = [x_B^W \quad y_B^W \quad z_B^W \quad \phi_B^W \quad \theta_B^W \quad \psi_B^W]^T$$

Body velocity vector:

$$\underline{V} = [\underline{v}_B^W \quad \underline{\omega}_B^W]^T$$

Wheel contact point velocity:

$$\underline{v}_C^W = B(\underline{p})\underline{V} + Q(\underline{\gamma})\dot{\underline{\gamma}} + \dot{\underline{\sigma}}$$

Hip and thigh joints:

$$\underline{\epsilon}_i = q_{H_i}, \quad \underline{\zeta}_i = [q_{U_i} \quad q_{Lo_i}]^T$$

Single leg kinematic model:

$$\underline{v}_{C_i}^W = B(\underline{p})\underline{V} + Q_{\epsilon_i}(\underline{\epsilon}_i)\dot{\underline{\epsilon}}_i + Q_{\zeta_i}(\underline{\zeta}_i)\dot{\underline{\zeta}}_i$$

Actively Articulated Suspension – Algorithmic Development

Steering Joint

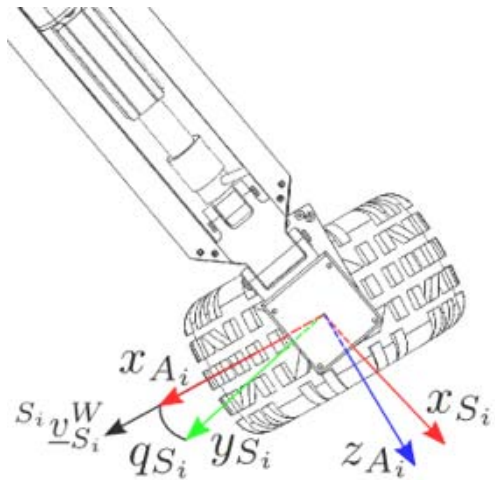

$${}^{S_i} \underline{v}_{S_i}^W = R_W^{S_i} \left[B(\underline{p}) + Q_{\epsilon_i}(\underline{\epsilon}_i) \dot{\underline{\epsilon}}_i + Q_{\zeta_i}(\underline{\zeta}_i) \dot{\underline{\zeta}}_i \right]$$

$$q_{S_i} = \arctan \left(\frac{{}^{S_i} v_{S_i,x}^W}{{}^{S_i} v_{S_i,y}^W} \right)$$

Drive Joint

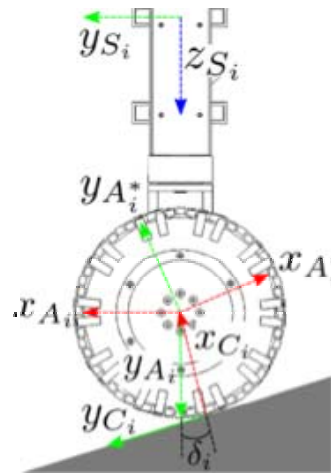

$$\dot{q}_{A_i^*} = \frac{R_W^{A_i} v_{A_i}^W}{L}$$

Wheel contact-point velocity estimation

$$v_{C_i,z}^W = \frac{\Delta r_{terrain,i,z}^W}{\Delta t}$$

Kinematic equation reduction

$$\underline{v}_{C,z}^W = S_B B(\underline{p}) \dot{\underline{p}} + S_Q Q(\underline{\gamma}) \dot{\underline{\gamma}}$$

Re-arrange

$$\begin{aligned} \underline{v}_{C,z}^W &= S_B B(\underline{p}) \dot{\underline{p}} + S_{Q_\epsilon} Q_\epsilon(\underline{\epsilon}) \dot{\underline{\epsilon}} + S_{Q_\zeta} Q_\zeta(\underline{\zeta}) \dot{\underline{\zeta}} \\ &= [S_B B \quad S_{Q_\epsilon} Q_\epsilon] \dot{\underline{\eta}} + S_{Q_\zeta} Q_\zeta(\underline{\zeta}) \dot{\underline{\zeta}}, \end{aligned}$$

Solve for the joint actuation rates

$$\dot{\underline{\zeta}} = (S_{Q_\zeta} Q_\zeta)^\# (\underline{v}_{C,z}^W - [S_B B \quad S_{Q_\epsilon} Q_\epsilon] \dot{\underline{\eta}})$$

Simulink Model



Software and Hardware In The Loop Testing Suite for the MAMMOTH Motion Controller

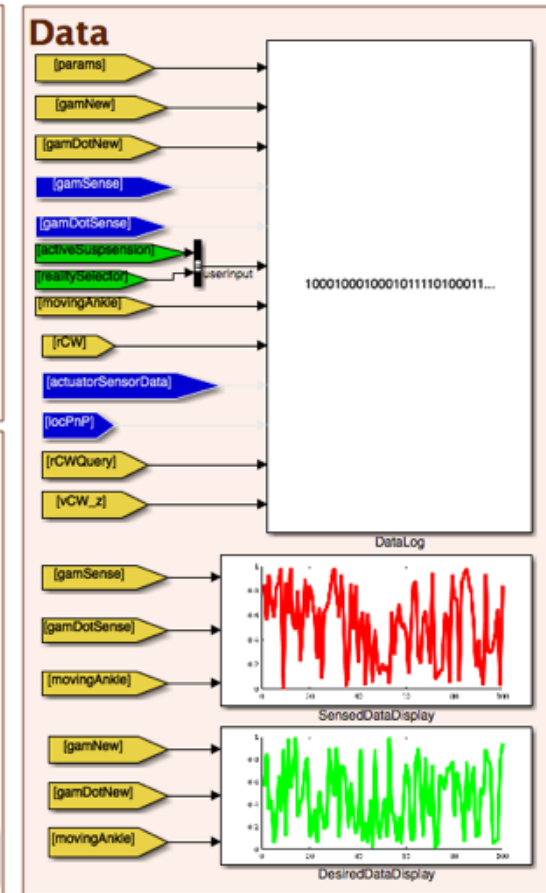
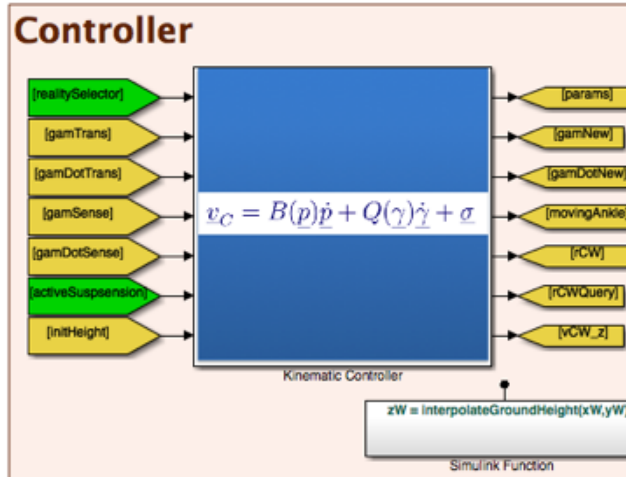
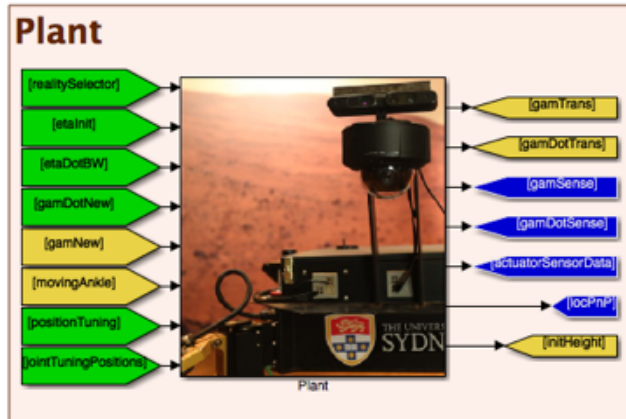
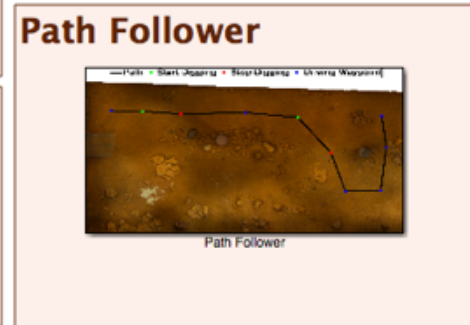
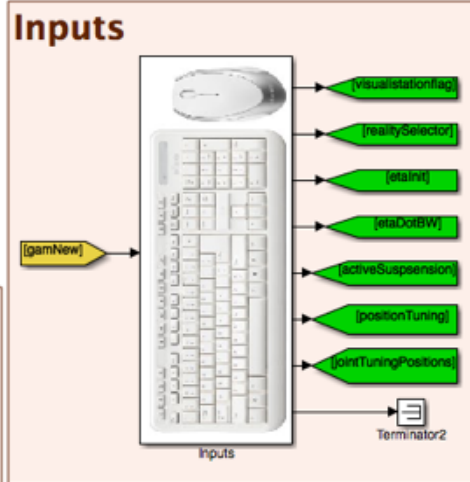
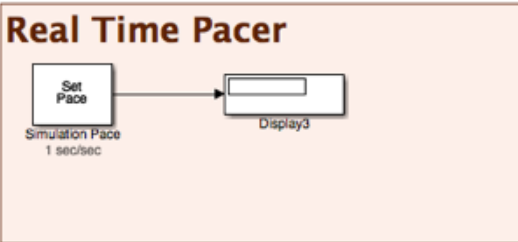
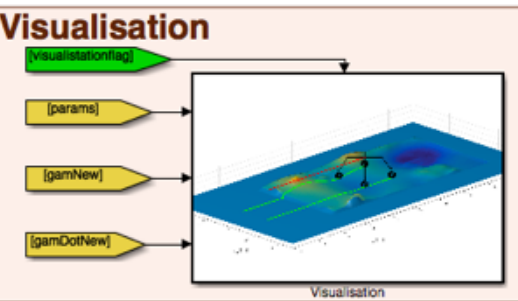
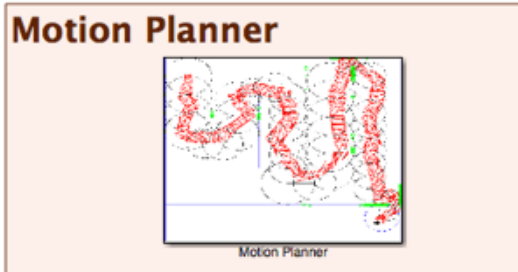

Simulink Model

Common interface for SIL and HIL blocks

SIL uses Simulink numerical ODE solver to run native simulation

SIL may be interfaced with external simulation applications:

- Gazebo, V-REP

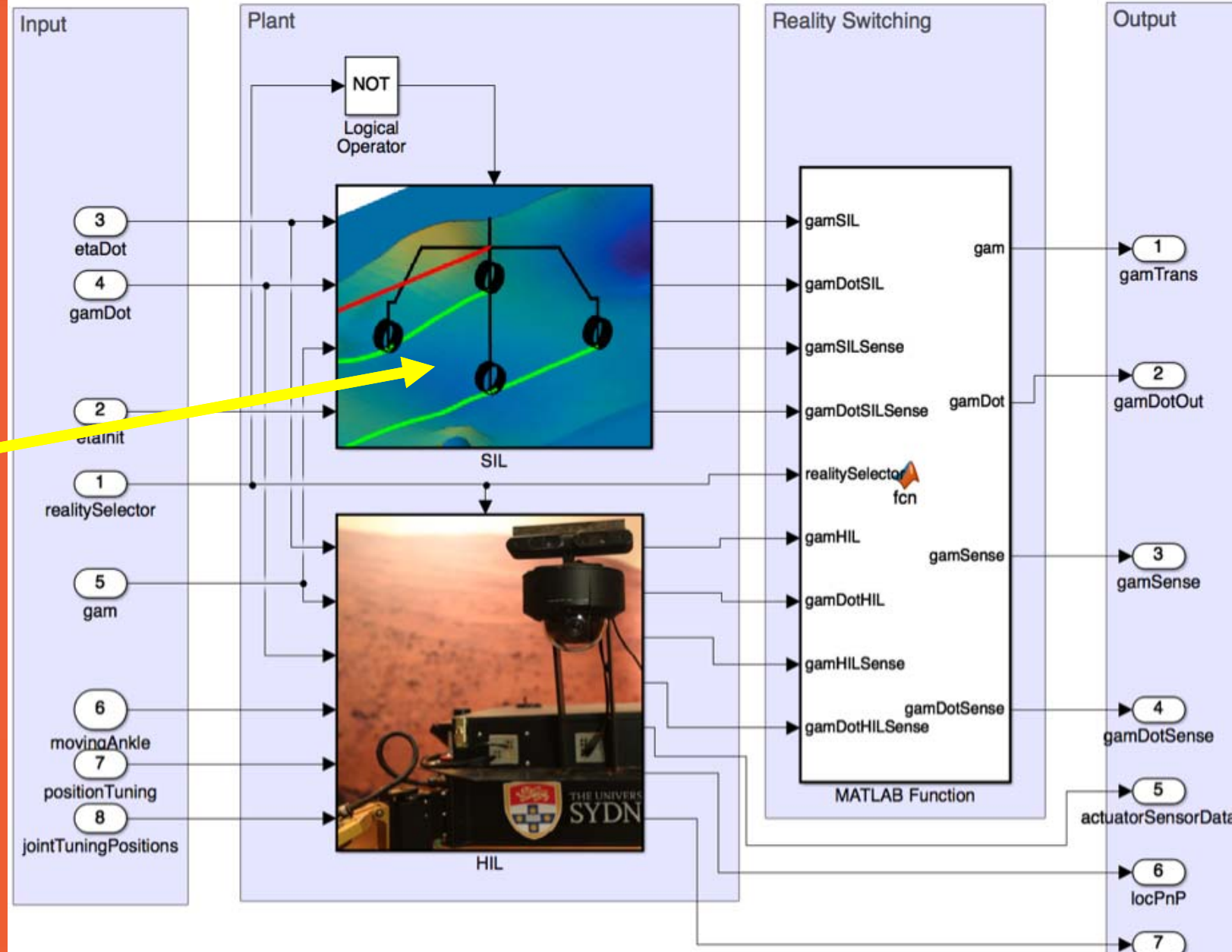

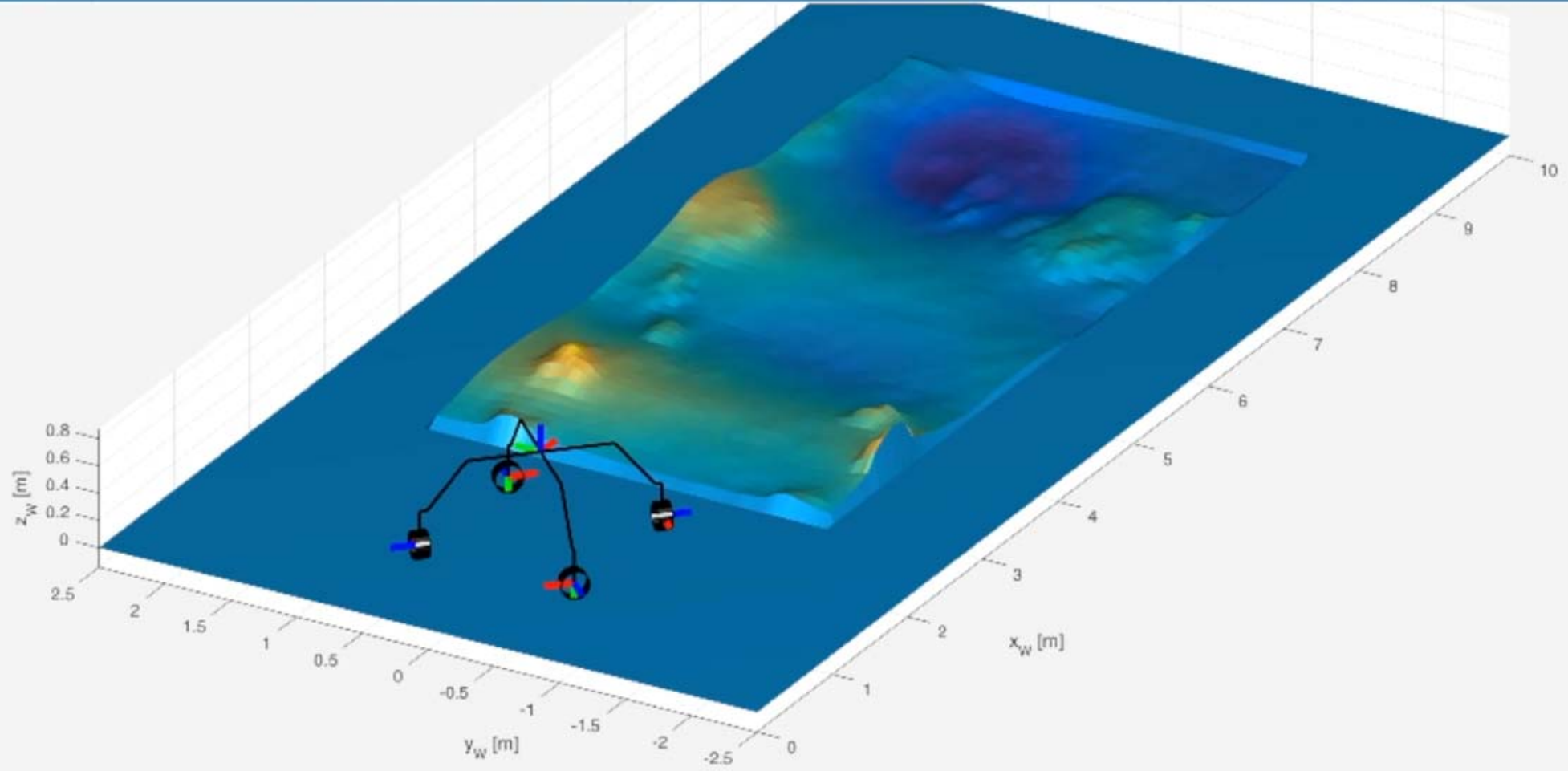

Simulink Model

Common interface for SIL and HIL blocks

HIL receives and transmits inputs and outputs over LAN

Robotics System Toolbox used to interface directly with ROS

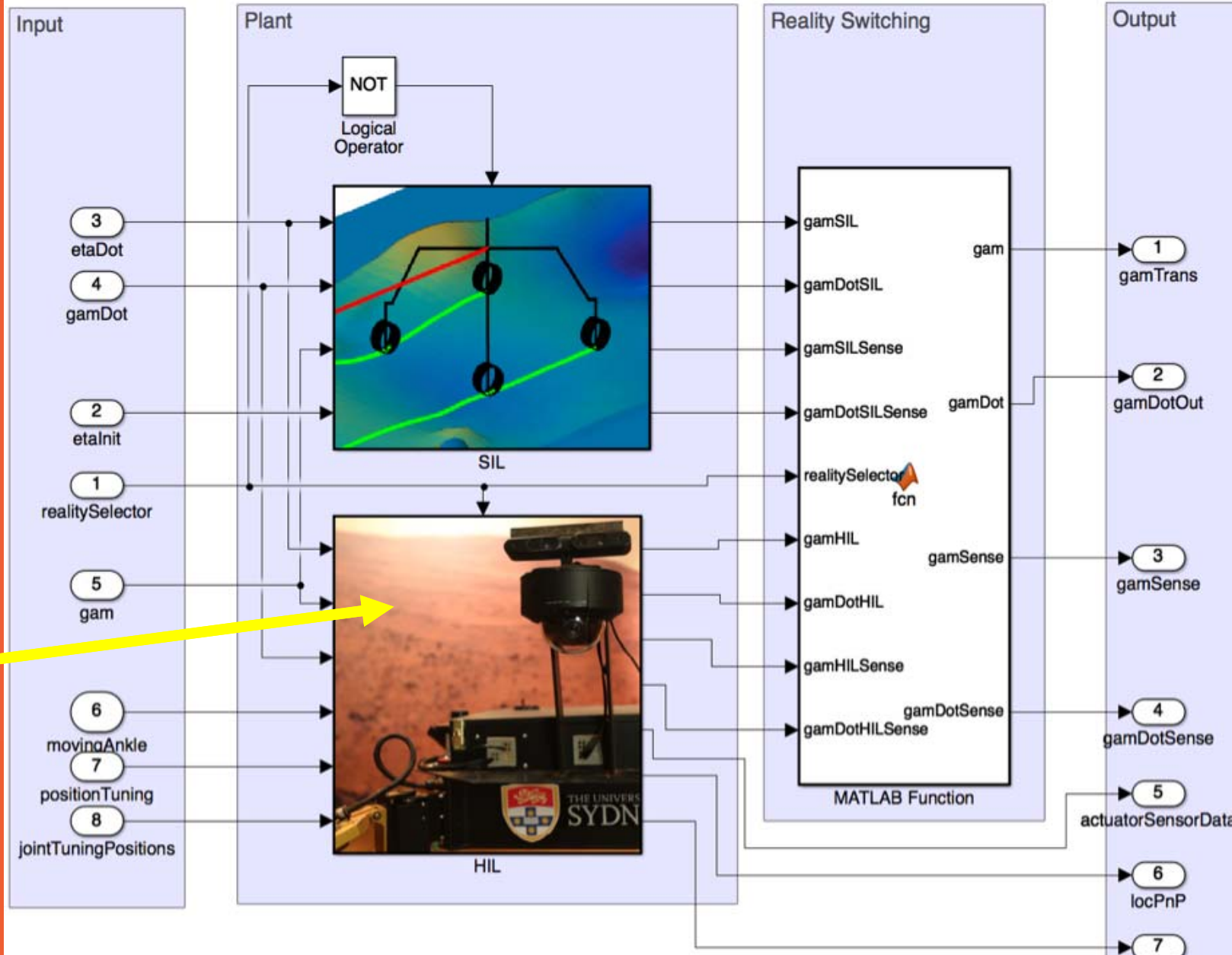





RGB-D Sensor

Input Body Velocity

Joint
Articulation
Rates

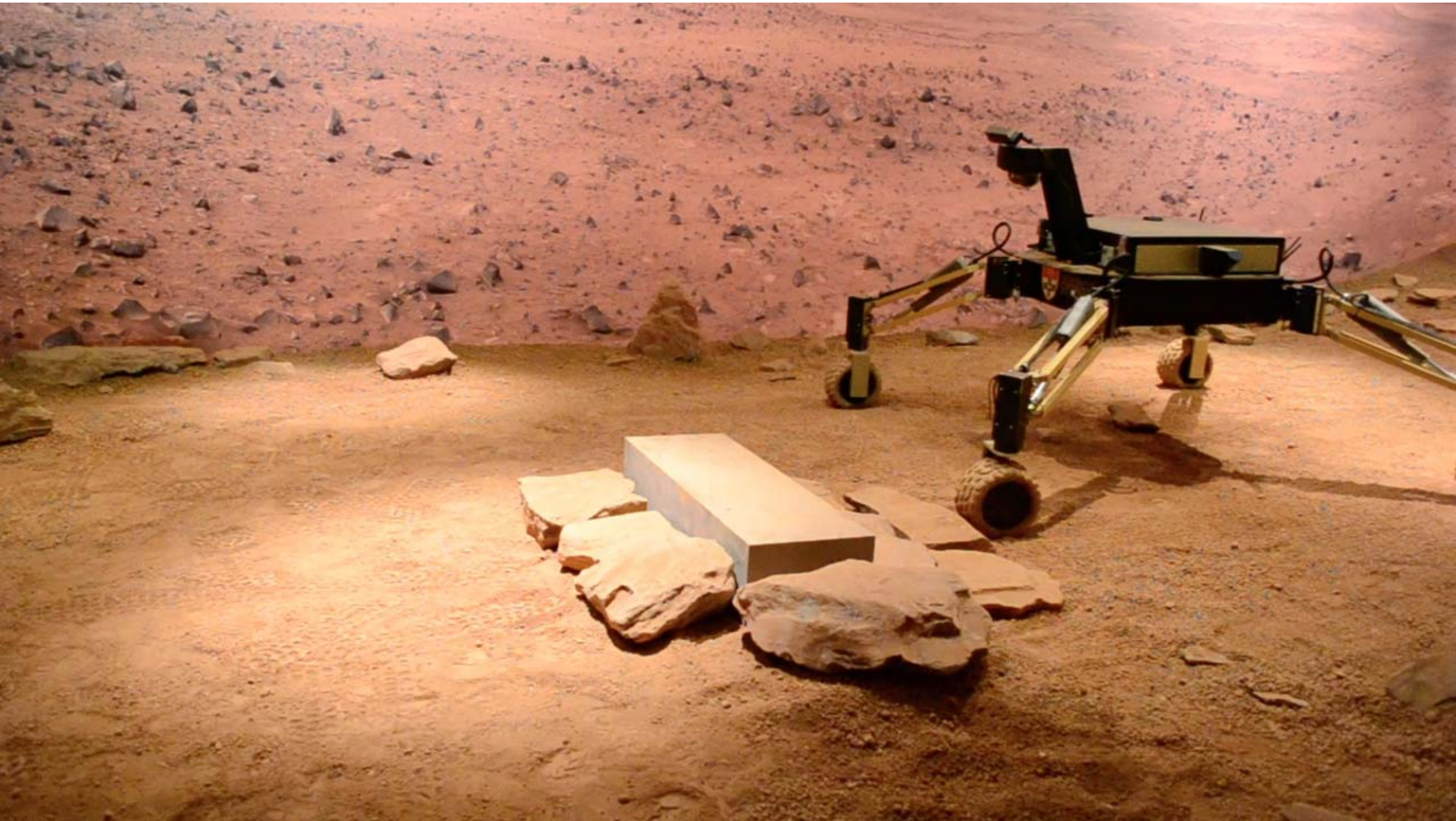

Analytical Tools

Rover Body and Wheel Contact Point Positions

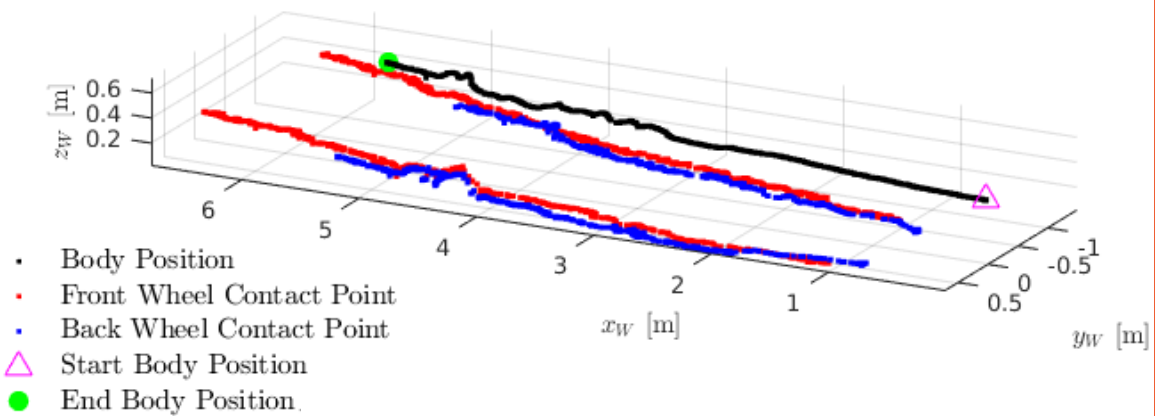

Other MAMMOTH Adventures – Digging Mission

MAMMOTH is used to dig a series of trenches along an operator-defined path

The Mawson Rover follows MAMMOTH to inspect each of the trenches



THE UNIVERSITY OF
SYDNEY



Multi-rover digging mission video



Digging Mission

- MAMMOTH
- Mawson

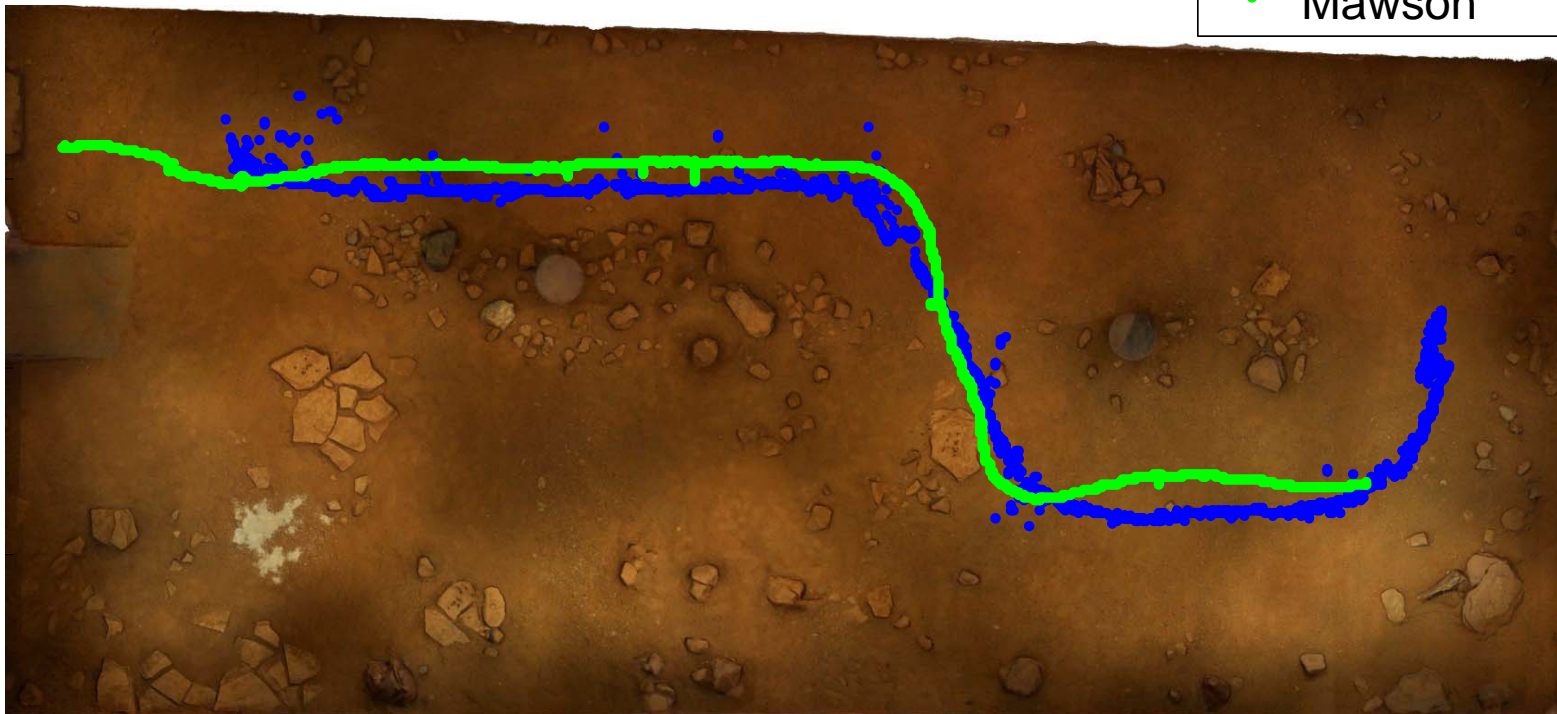

MAMMOTH the Farmer





Conclusions

- Novel wheel-on-leg platform
- Model-based design for rapid software development
- Interfacing with various sensors/actuators/software-in-the-loop applications
- Variety of applications

