





Five Cool Things You Can Do With Powertrain Blockset

Mike Sasena, PhD
Product Manager

Agenda

- Introduction to Powertrain Blockset

- Five cool things you can do with it: Why are these cool?
 1. Engine control design / calibration  Reduce time on HIL, dyno, vehicle testing
 2. Fuel economy sensitivity  Design more robust systems
 3. Design optimization studies  Explore wider search space
 4. Multidomain simulation via Simscape  Validate detailed subsystem design
 5. Hardware-in-the-loop (HIL) testing  Validate controller virtually

Agenda

- Introduction to Powertrain Blockset
- Five cool things you can do with it:
 1. Engine controller calibration
 2. Fuel economy sensitivity
 3. Design optimization studies
 4. Multidomain simulation via Simscape
 5. Hardware-in-the-loop (HIL) testing

Powertrain Blockset

- New product: R2016b+ (web release)
- Goals:
 - Provide starting point for engineers to build good plant / controller models
 - Provide open and documented models
 - Provide very fast-running models that work with popular HIL systems

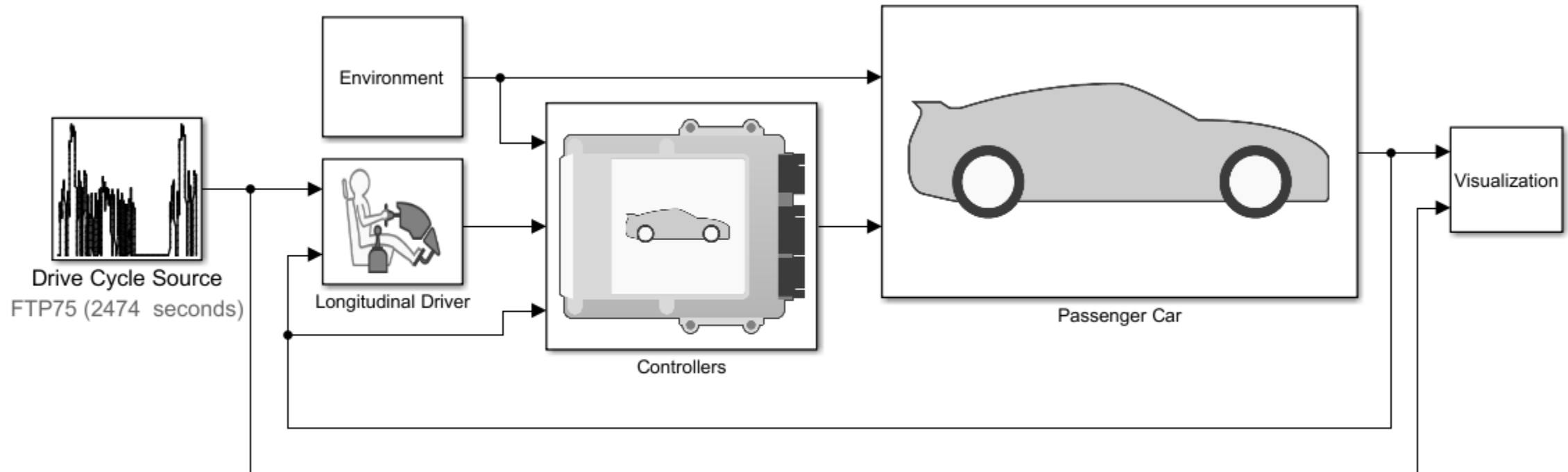

Powertrain Blockset Features

Library of blocks

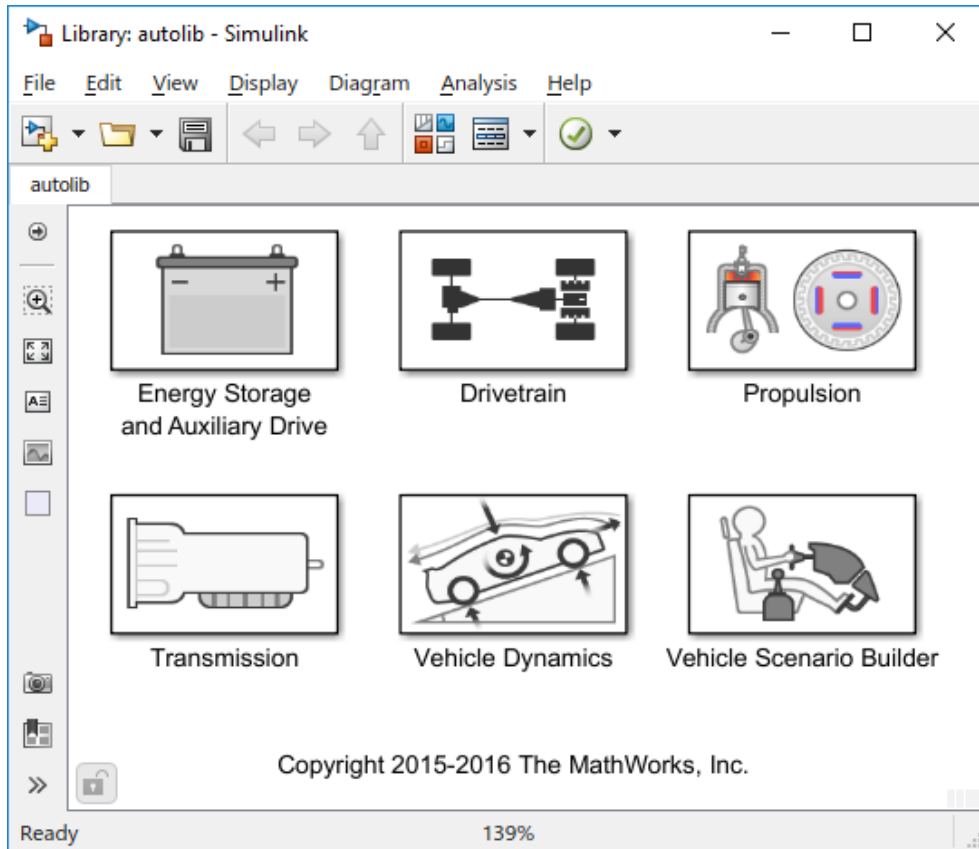

Pre-built reference applications

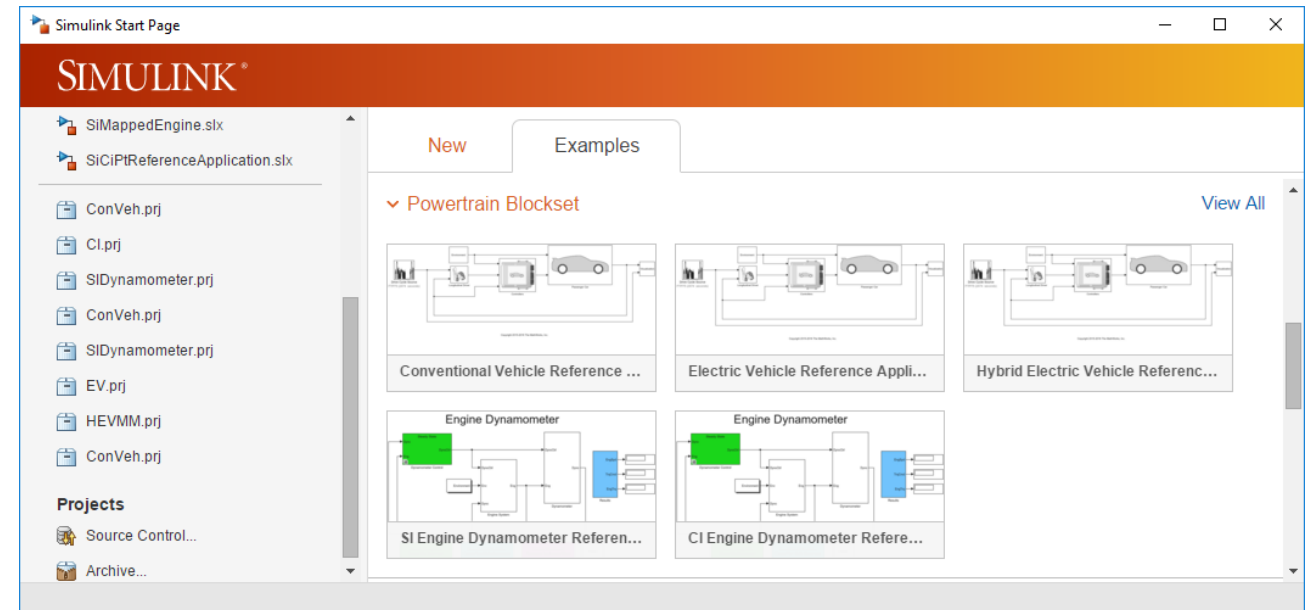

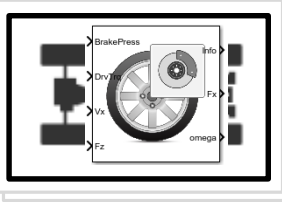

Drivetrain

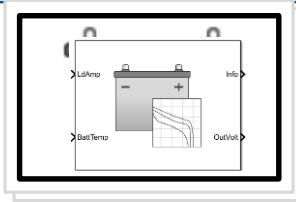

Energy Storage and Auxiliary Drive

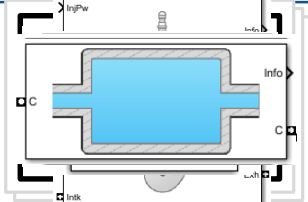

Propulsion

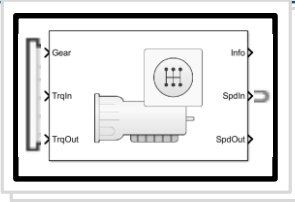

Transmission

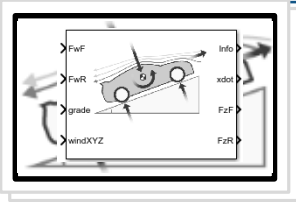

Vehicle Dynamics

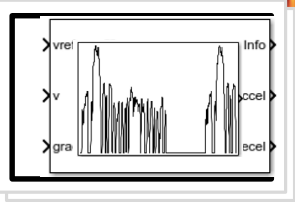

Vehicle Scenario Builder

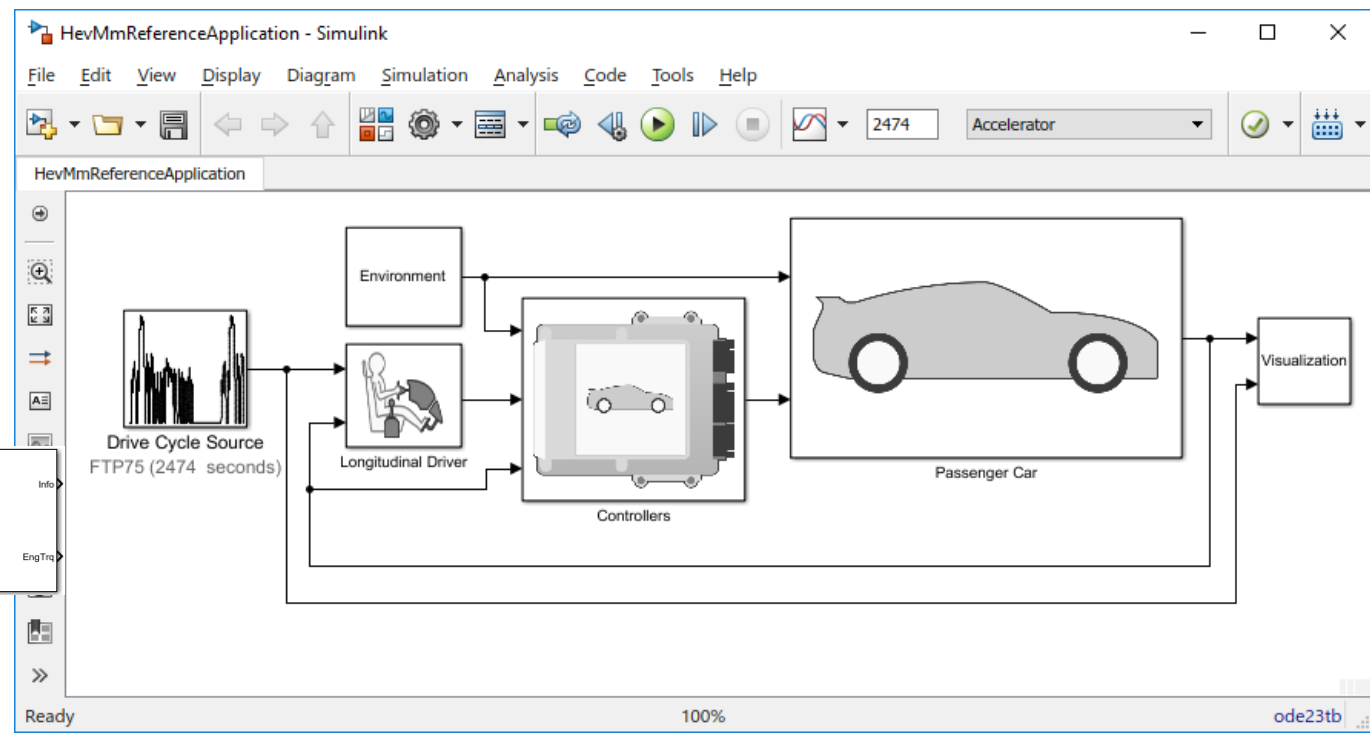
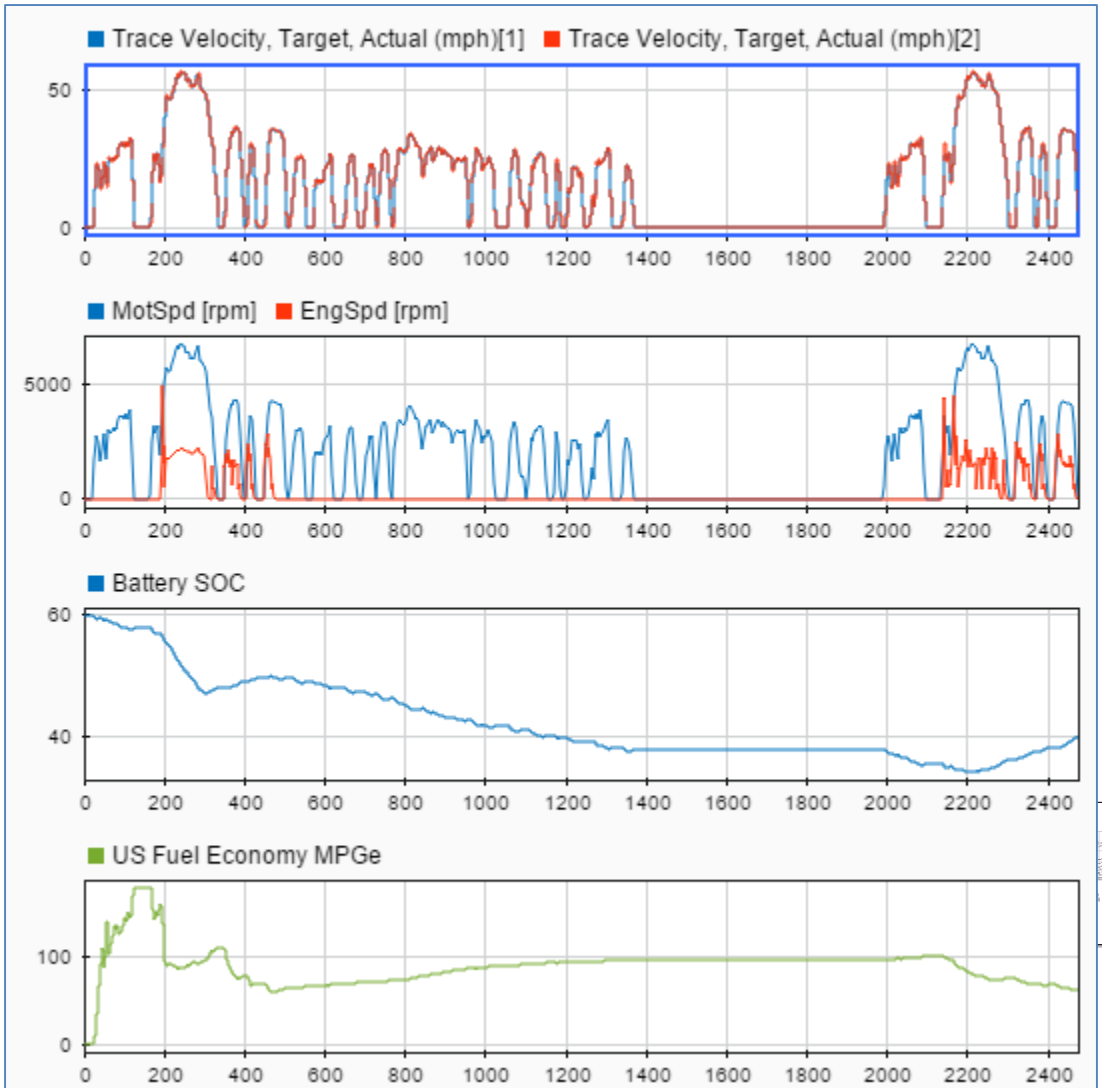

Reference Applications

- Full vehicle models (conventional, EV, multi-mode HEV)
- Virtual engine dynamometers (compression ignition, spark ignition)

The screenshot displays the Simulink Start Page interface. On the left, a sidebar lists recent files and projects, including 'SiMappedEngine.slx', 'SiCiPtReferenceApplication.slx', and various project files like 'ConVeh.prj', 'Cl.prj', 'SiDynamometer.prj', 'EV.prj', and 'HEVMM.prj'. The main area is divided into 'New' and 'Examples' tabs. Under the 'Examples' tab, a 'Powertrain Blockset' is expanded, showing five reference application thumbnails: 'Conventional Vehicle Reference ...', 'Electric Vehicle Reference Appli...', 'Hybrid Electric Vehicle Referenc...', 'SI Engine Dynamometer Referen...', and 'CI Engine Dynamometer Refere...'. Each thumbnail includes a schematic diagram of the system and a 'View All' link.

Four Use Cases. One Framework.

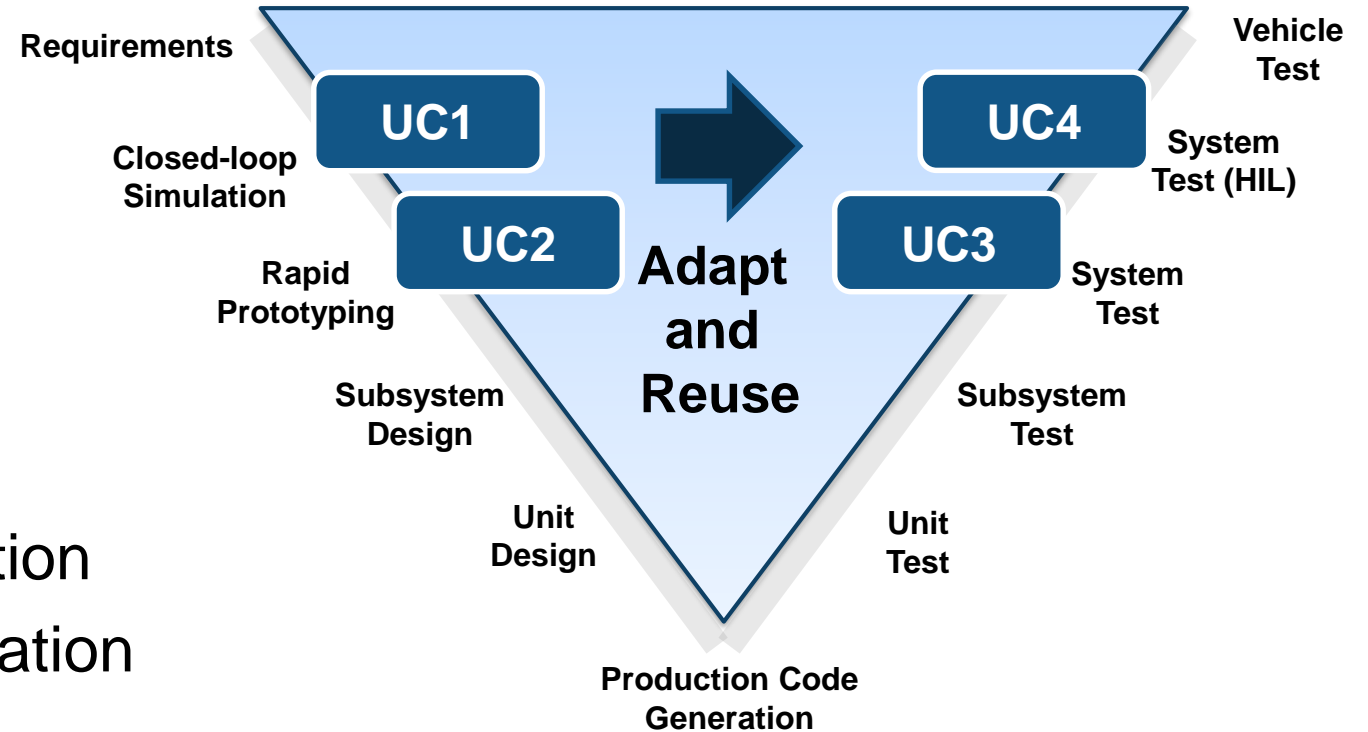

Use Cases:

1. System design and optimization
2. Controller parameter optimization
3. System integration test
4. Software-hardware integration test (HIL)

Agenda

- Introduction to Powertrain Blockset

- Five cool things you can do with it:

1. Engine control design / calibration
2. Fuel economy sensitivity
3. Design optimization studies
4. Multidomain simulation via Simscape
5. Hardware-in-the-loop (HIL) testing



Reduce time on HIL, dyno, vehicle testing

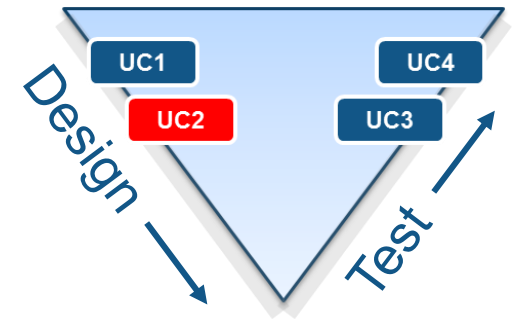

Engine Control Design / Calibration

- Powertrain Blockset includes virtual engine dynamometer reference applications
- These can be used for a variety of engine controls development and calibration activities
- Includes several pre-defined experiments

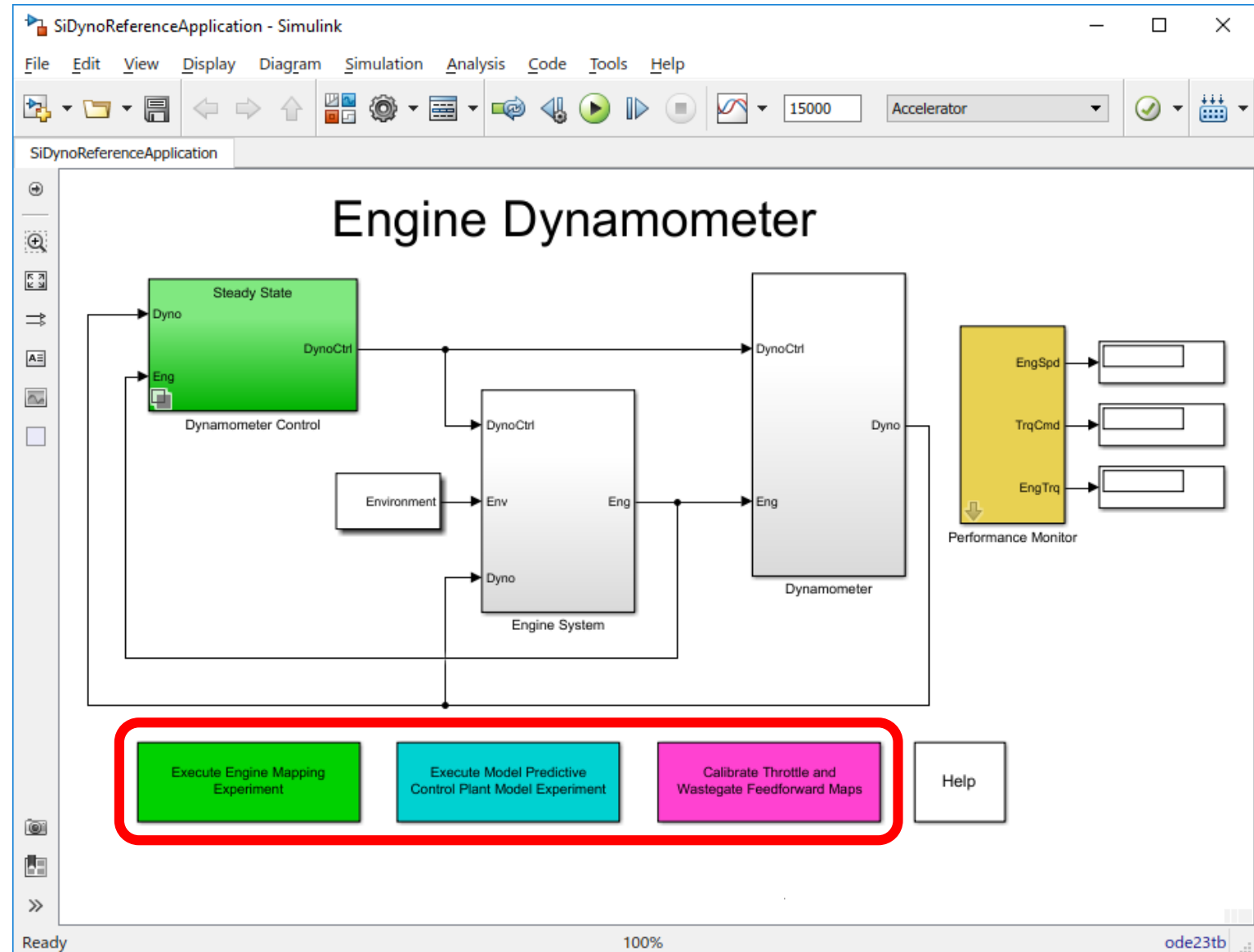

Automated Calibration Experiment

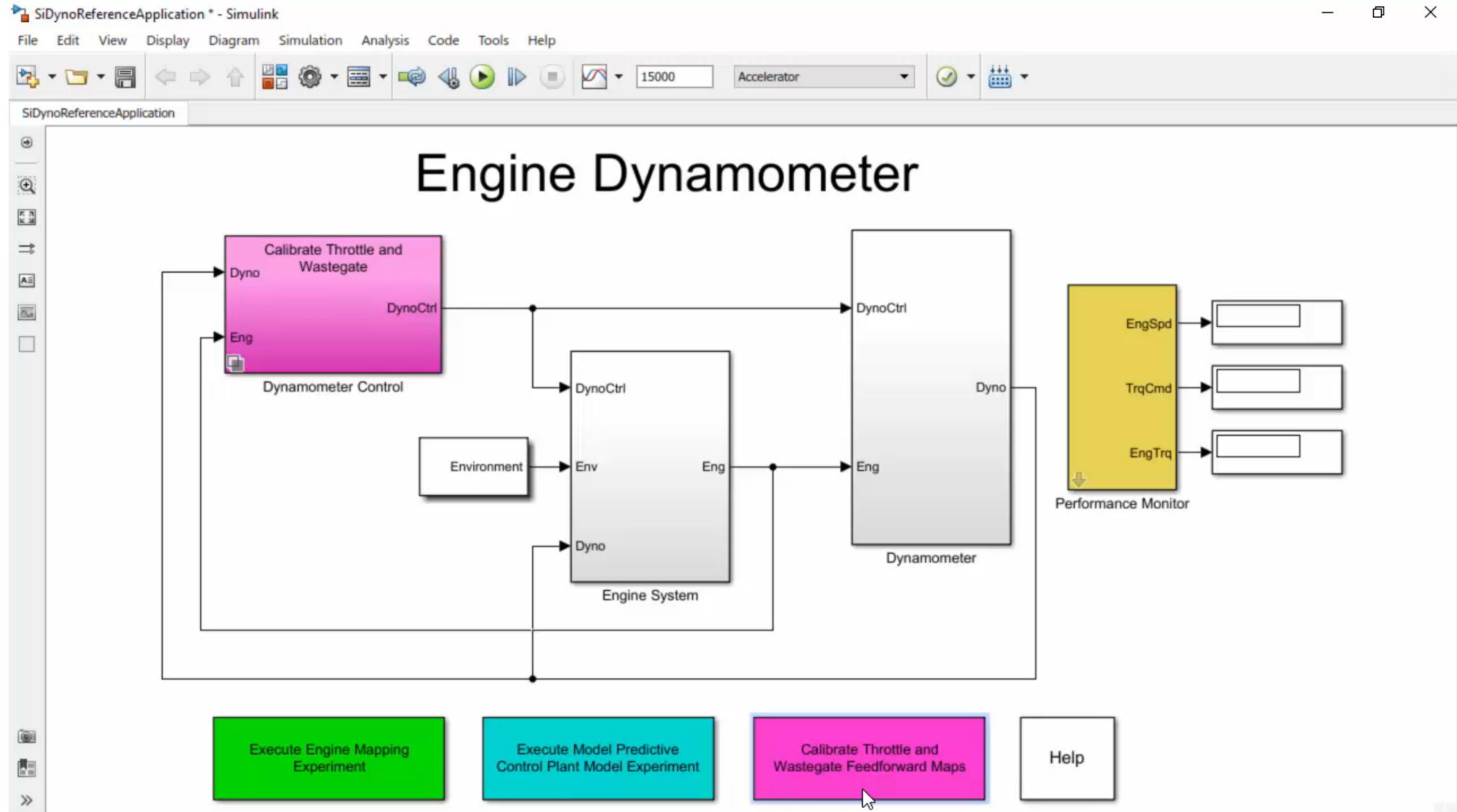

Executable Test Specification

- Describe the calibration procedure as a Stateflow chart (not a Word doc)
- Test the procedure virtually
- Validate / plan calibration procedure with test engineers
- Start testing on real hardware with refined procedure

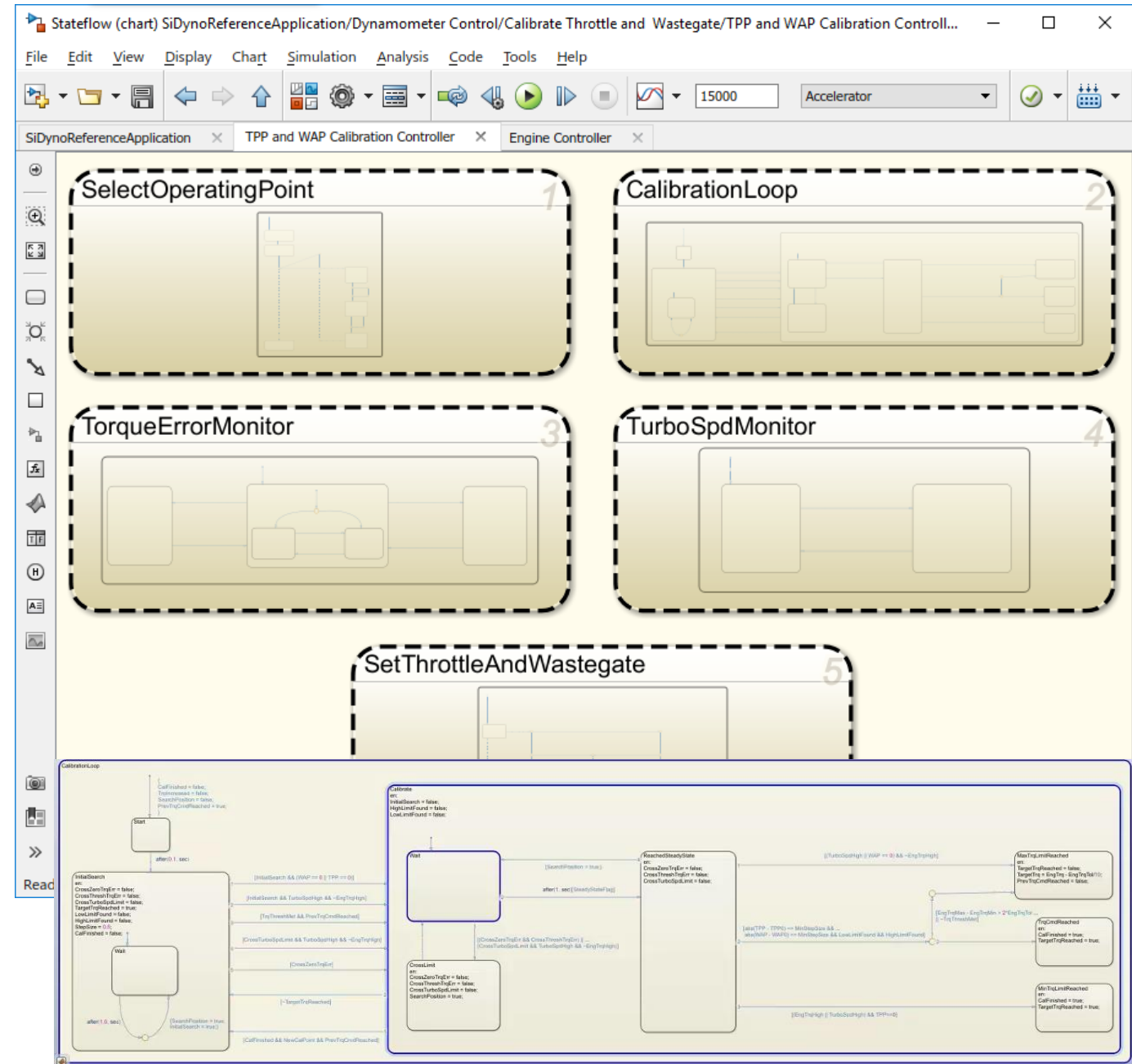

Flexible Testing Framework

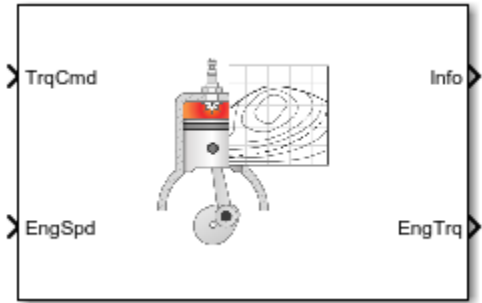

Use Powertrain Blockset mapped engine blocks with your own data

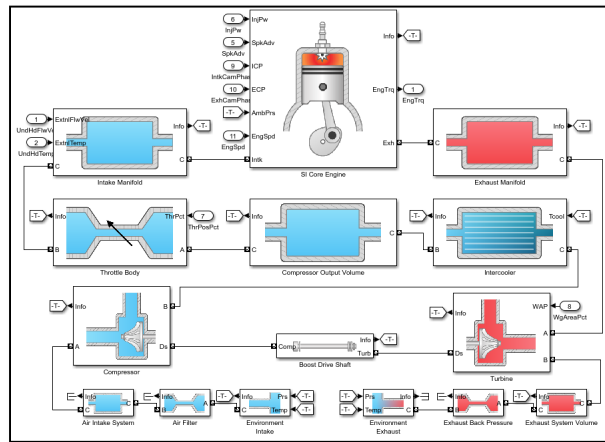
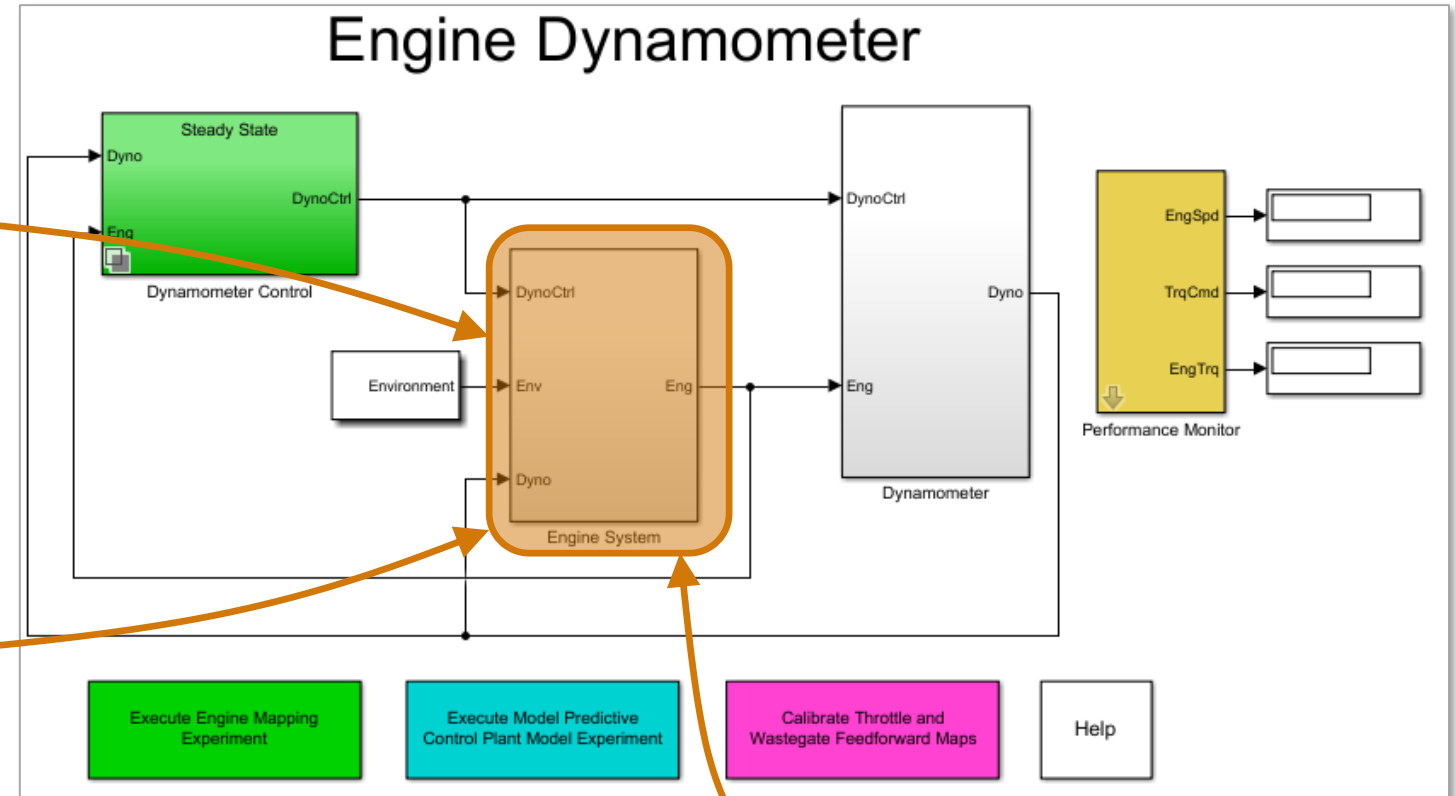

Create custom engine models using Powertrain Blockset library components

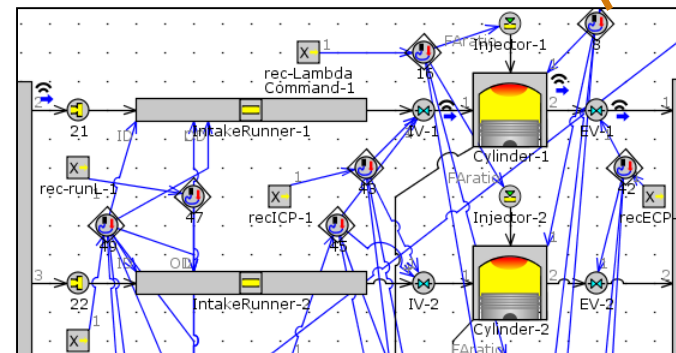

Connect in your own CAE model (e.g., GT-POWER)

Controls-oriented Model Creation

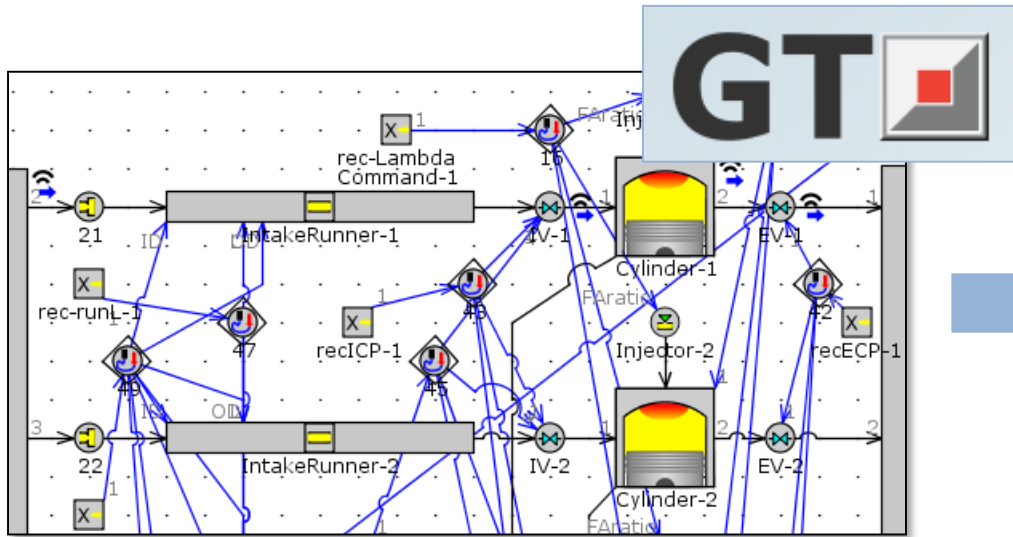

Detailed, design-oriented model

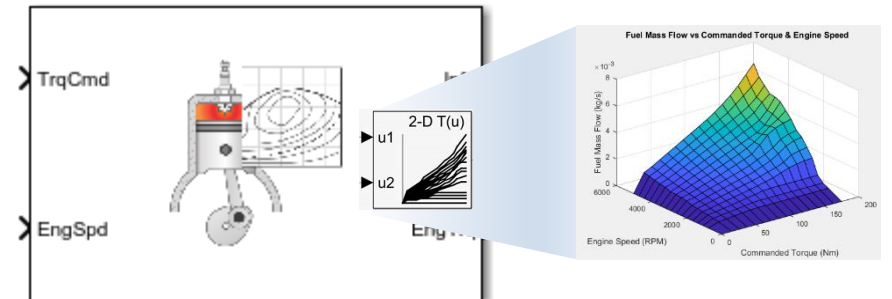
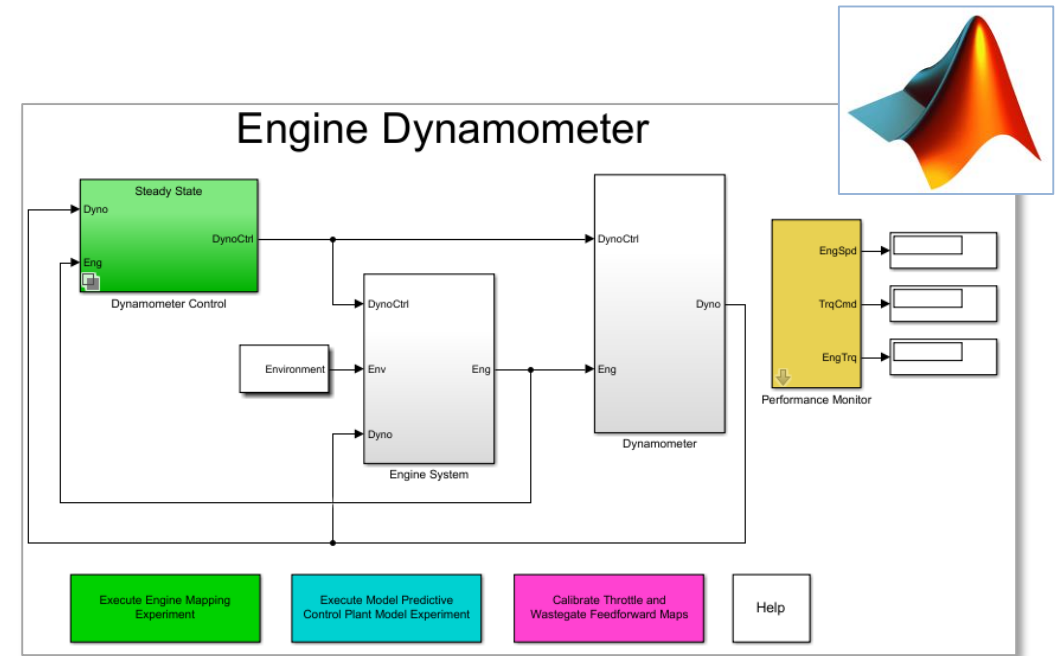

Fast, but accurate controls-oriented model

Engine Control Design / Calibration

- Gather “as calibrated” engine maps
- Automatically calibrate throttle / wastegate
- Define and simulate custom calibration procedures
- Generate engine maps from CAE models

How cool is that?



Agenda

- Introduction to Powertrain Blockset

- Five cool things you can do with it:

1. Engine control design / calibration
2. Fuel economy sensitivity
3. Design optimization studies
4. Multidomain simulation via Simscape
5. Hardware-in-the-loop (HIL) testing



Design more robust systems

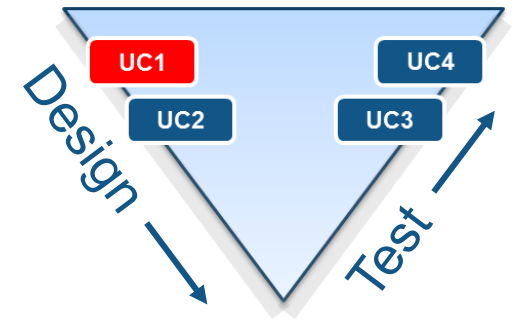

FTP75 Simulation

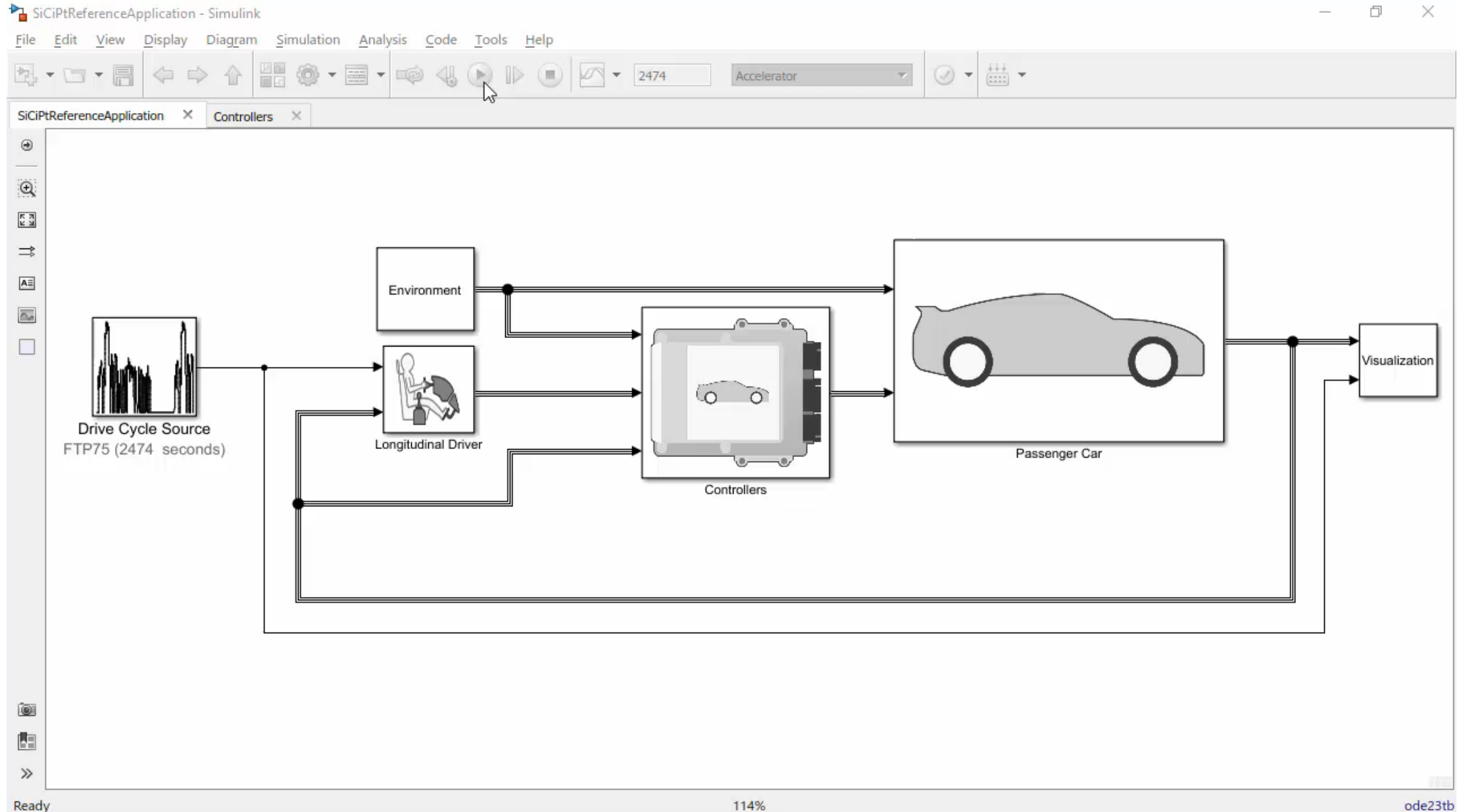

Sensitivity Analysis

- Determine sensitivity of the fuel economy to changes in design parameters
- Configure Monte Carlo simulations using Simulink Design Optimization's graphical interface
 - Create sample sets using random & pseudo-random techniques
 - Define behaviors of interest in the model
- Speed up performance using parallel computing
 - Local: Parallel Computing Toolbox
 - Cluster: MATLAB Distributed Computing Server

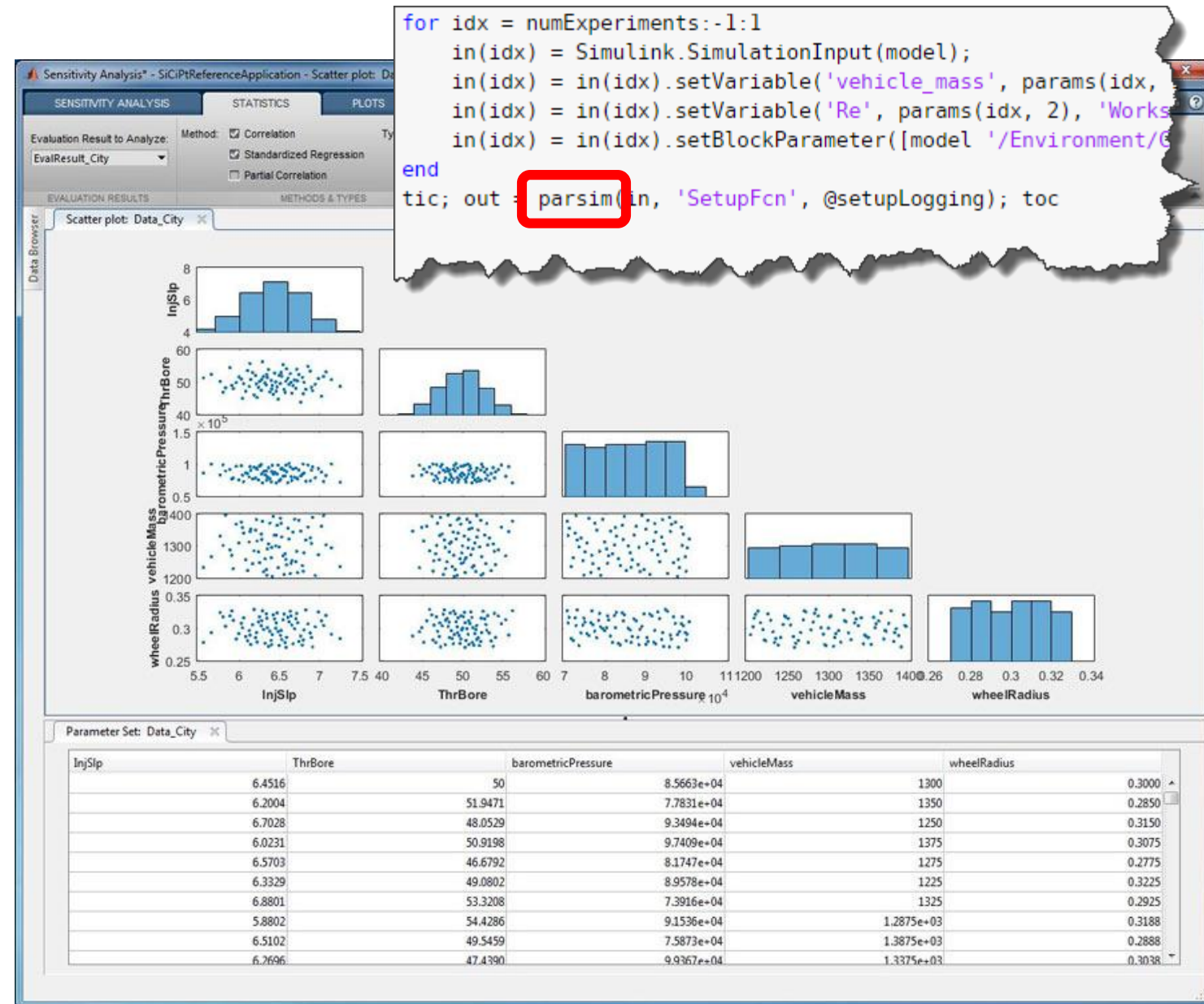

Sensitivity Analysis Results

City Cycle

- High variation in fuel economy for variations in wheel radius, vehicle mass, and other parameters
- High sensitivity to variation in wheel radius and injector slope values

Highway Cycle

- Low variation in fuel economy for variations in wheel radius, vehicle mass, and other parameters
- High sensitivity to variation in barometric pressure, but little else

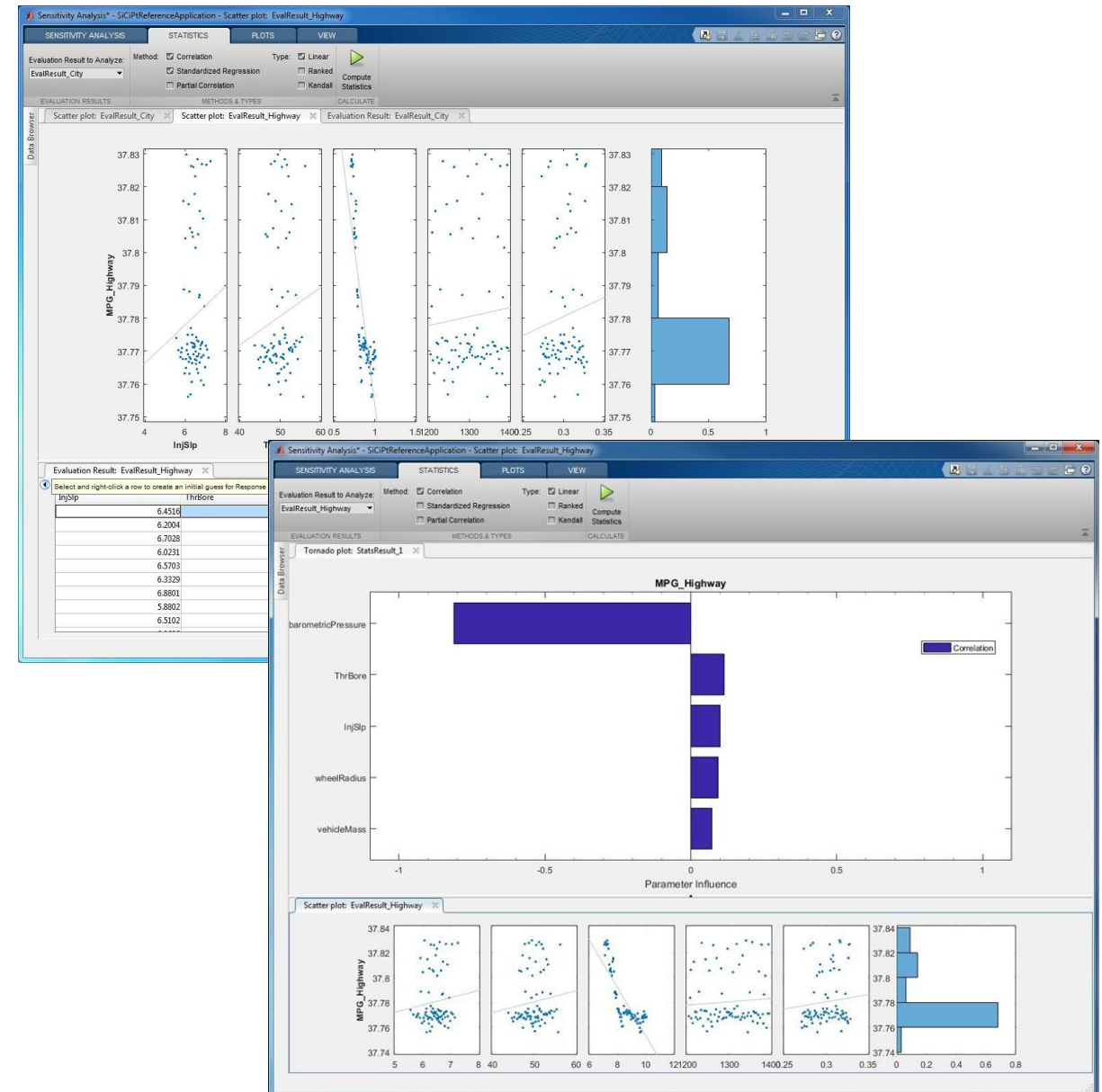

Fuel economy sensitivity

- Run fuel economy, emissions and performance simulations at 50 – 100x real time
- Perform Monte Carlo studies to analyze sensitivity
- Use parallel computing to accelerate the process

How cool is that?



Agenda

- Introduction to Powertrain Blockset
- Five cool things you can do with it:
 1. Engine control design / calibration
 2. Fuel economy sensitivity
 3. **Design optimization studies**  **Explore wider search space**
 4. Multidomain simulation via Simscape
 5. Hardware-in-the-loop (HIL) testing

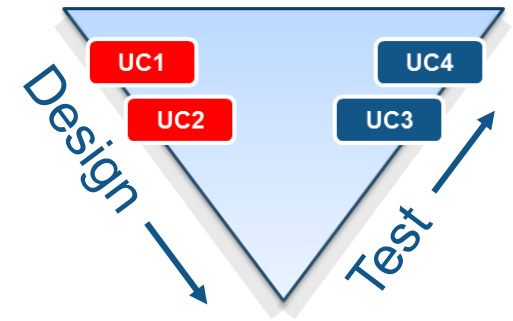

Powertrain Blockset Enables Accessible Optimization Capabilities

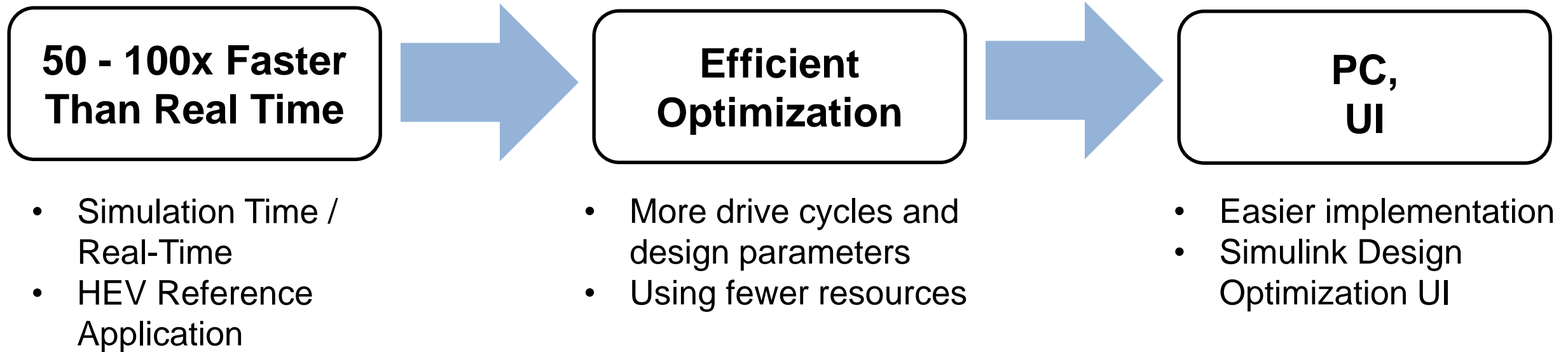

Multi-Mode HEV Review

SAE International

2013-01-1476
 Published 04/08/2013
 Copyright © 2013 SAE International
 doi:10.4271/2013-01-1476
 saealtpow.saejournals.org

Development of a New Two-Motor Plug-In Hybrid System

Naritomo Higuchi, Yoshihiro Sunaga, Masashi Tanaka and Hiroo Shimada
 Honda R&D Co., Ltd.

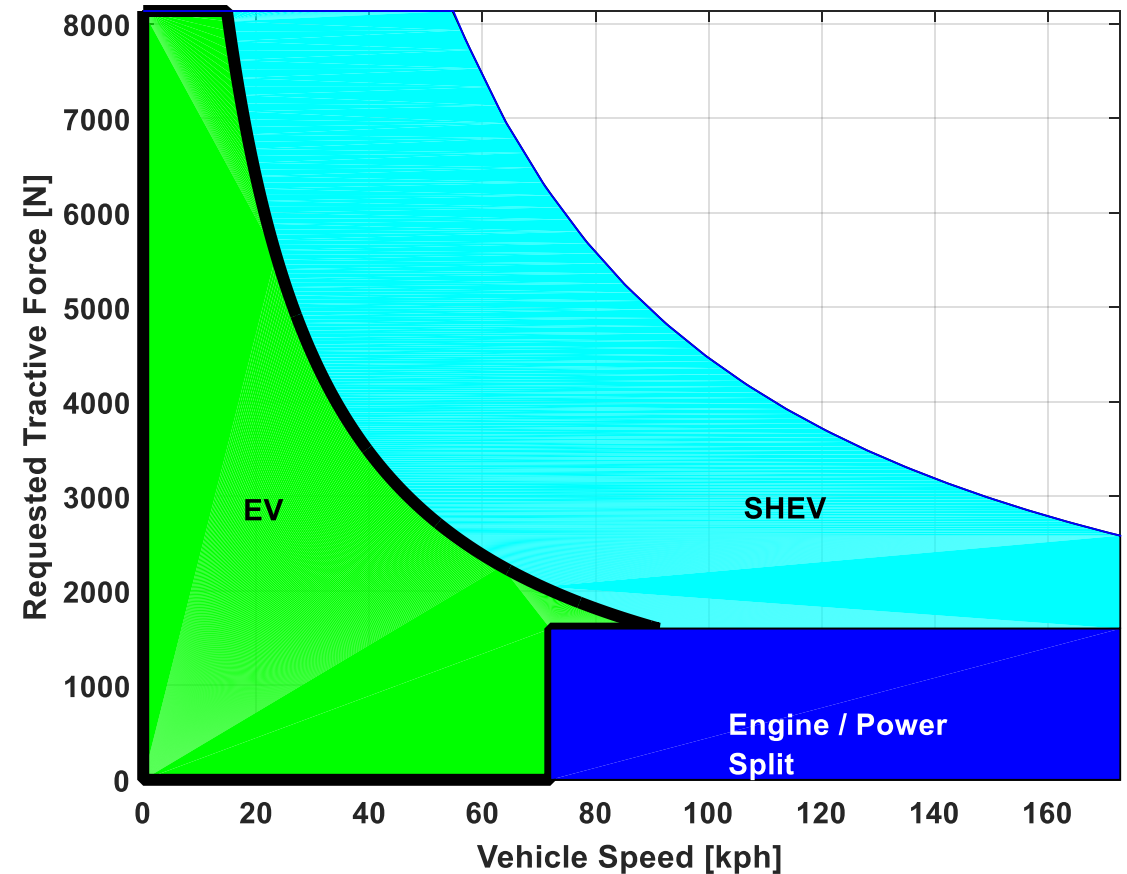
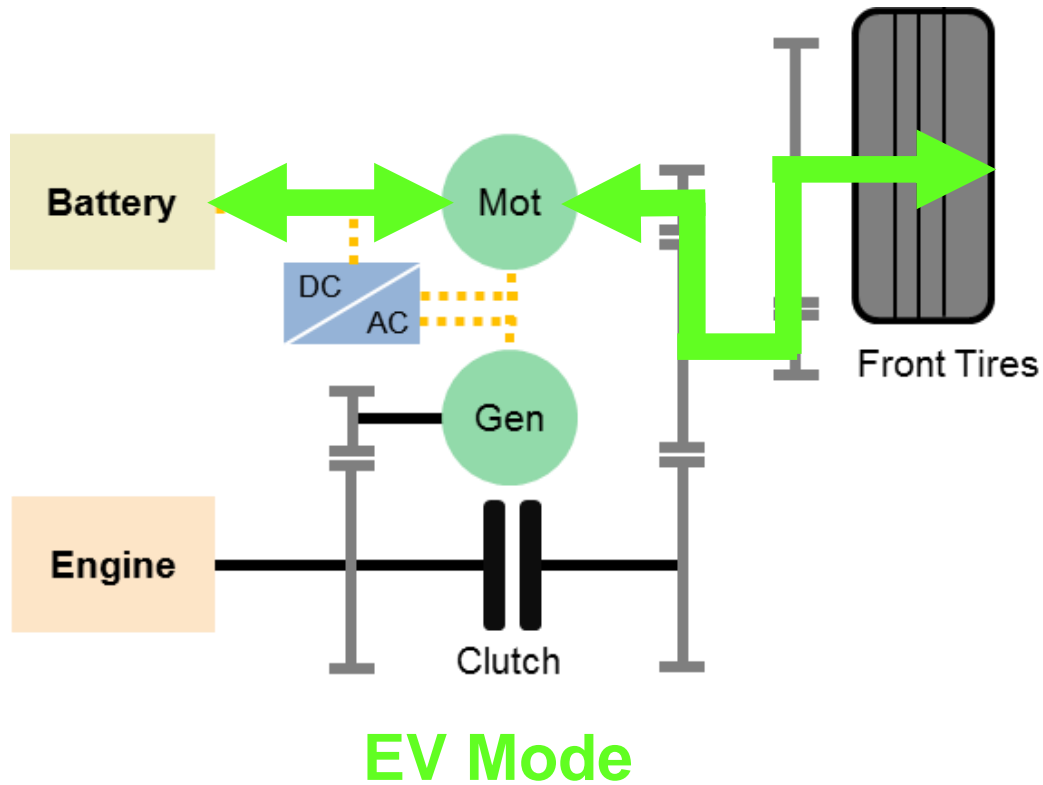

Multi-Mode HEV Review

SAE International

2013-01-1476
 Published 04/08/2013
 Copyright © 2013 SAE International
 doi:10.4271/2013-01-1476
 saealtpow.saejournals.org

Development of a New Two-Motor Plug-In Hybrid System

Naritomo Higuchi, Yoshihiro Sunaga, Masashi Tanaka and Hiroo Shimada
 Honda R&D Co., Ltd.

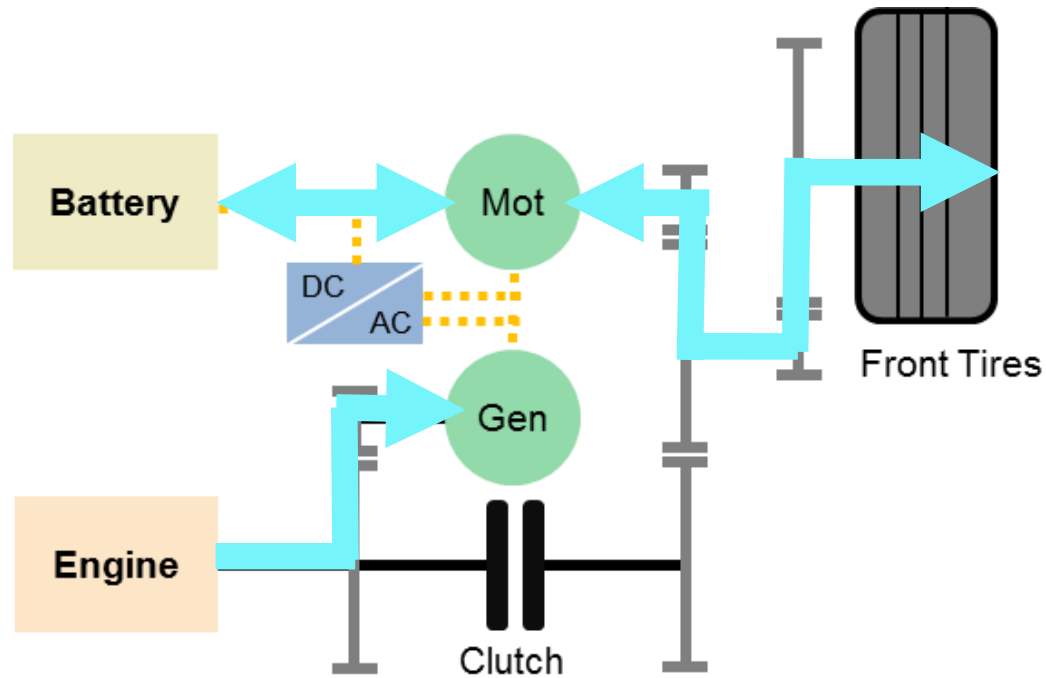

SHEV Mode

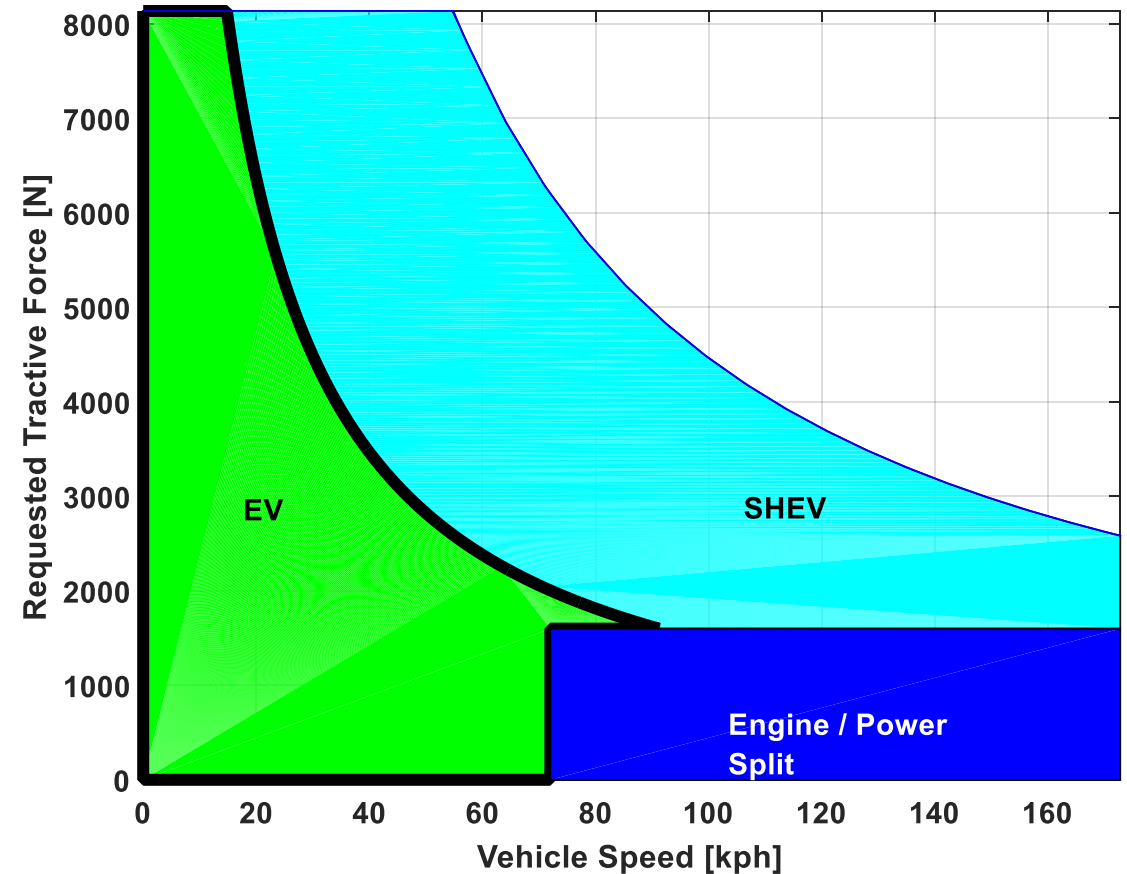

Multi-Mode HEV Review

SAE International

2013-01-1476
 Published 04/08/2013
 Copyright © 2013 SAE International
 doi:10.4271/2013-01-1476
 saealtpow.saejournals.org

Development of a New Two-Motor Plug-In Hybrid System

Naritomo Higuchi, Yoshihiro Sunaga, Masashi Tanaka and Hiroo Shimada
 Honda R&D Co., Ltd.

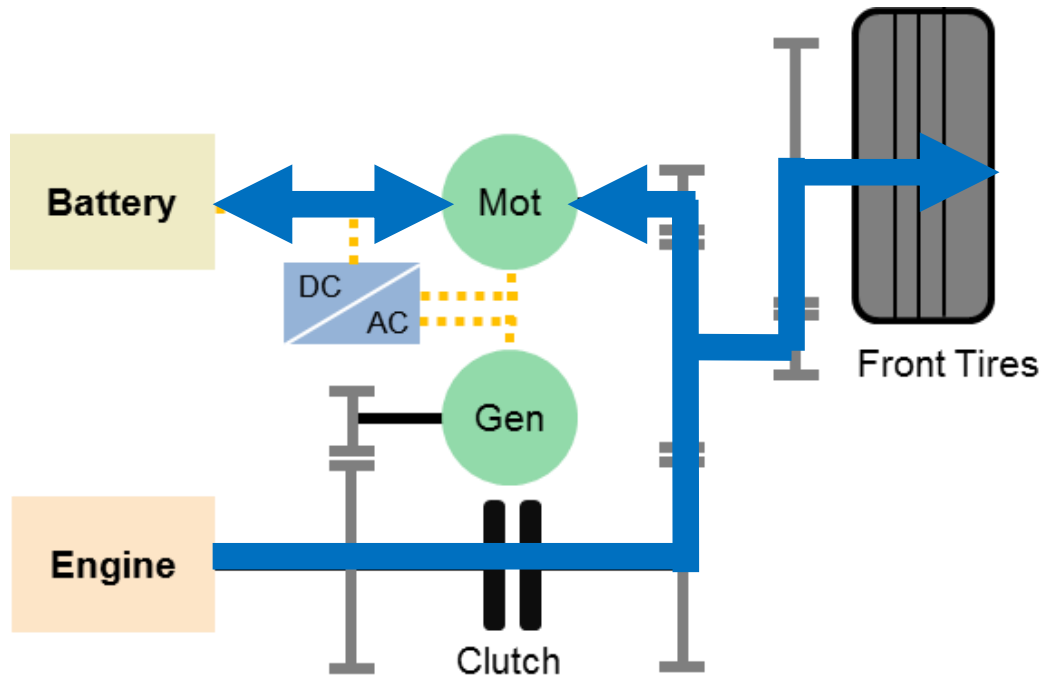

Engine Mode

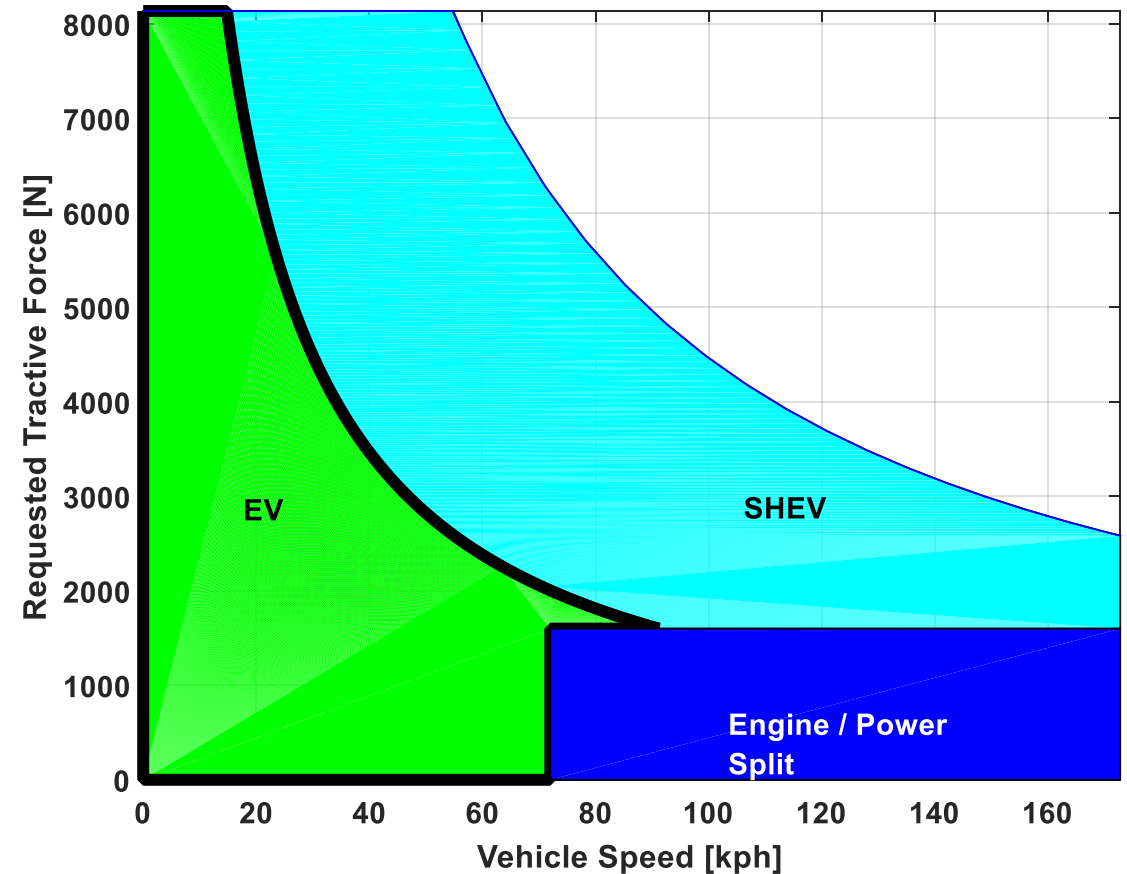

Design Optimization Problem Statement

- Maximize MPGe
 - FTP75 and HWFET
 - Weighted MPGe = $0.55(\text{FTP75}) + 0.45(\text{HWFET})$

- Optimize Parameters:
 - 5 control parameters
 - EV, SHEV, Engine mode boundaries
 - 1 hardware parameter
 - Final differential ratio

- Use PC
 - Simulink Design Optimization (SDO)
 - Parallel Computing Toolbox (PCT)

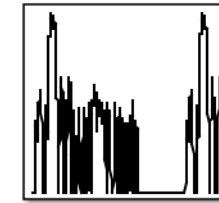

Drive Cycle Source1
FTP75 (2474 seconds)

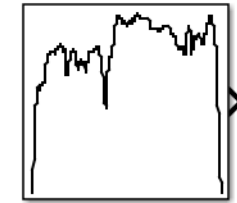

Drive Cycle Source
HWFET (765 seconds)

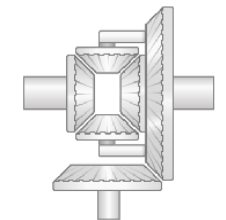
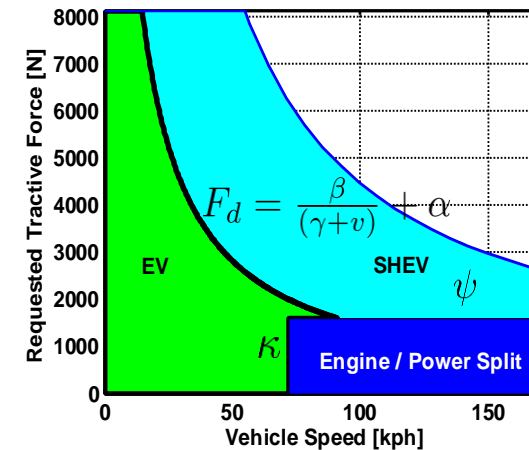

Differential Ratio



Lenovo ThinkPad T450s
Dual Core i7 2.60GHz
12 GB RAM

Simulink Design Optimization

Speed Up Best practices

- Accelerator mode
- Fast Restart



- Use Parallel Computing Toolbox

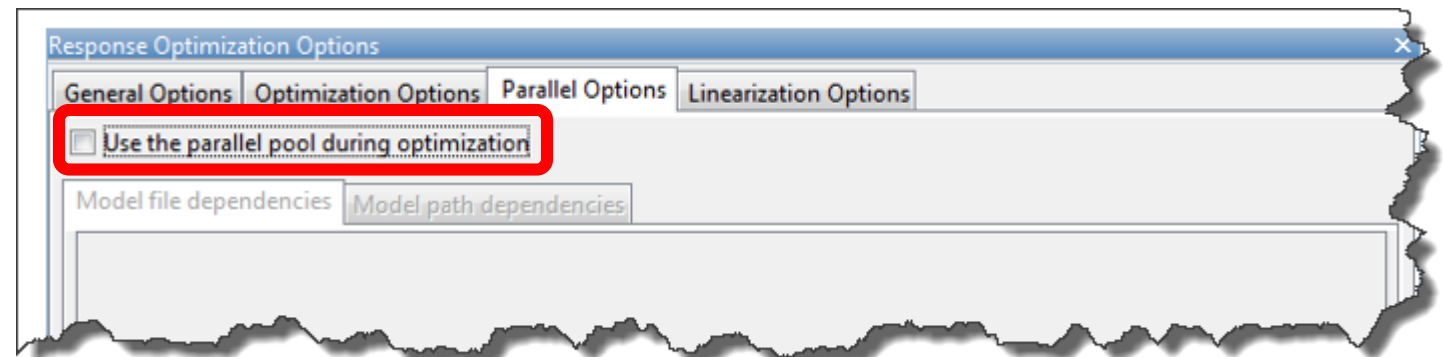

- Specify Simulation timeout

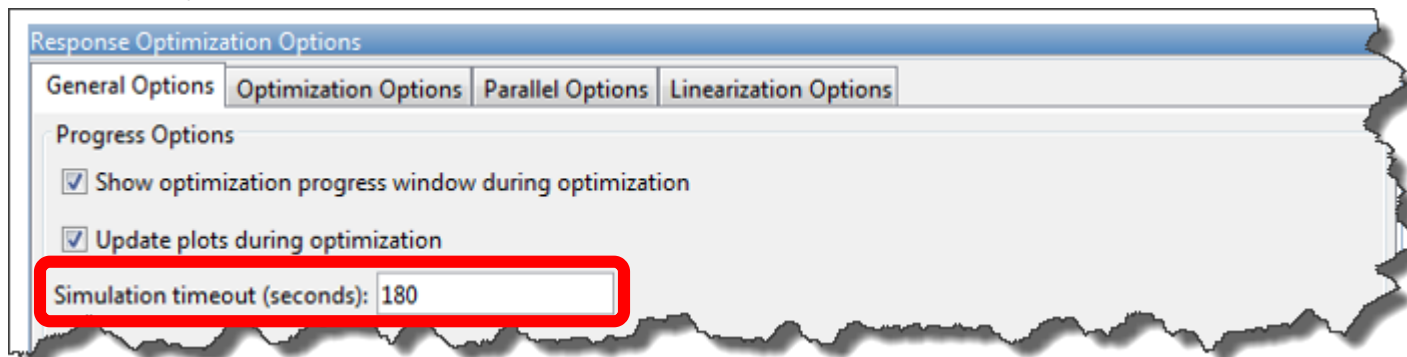

Optimization Results

Simulink Design Optimization → Response Optimization

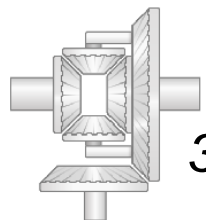
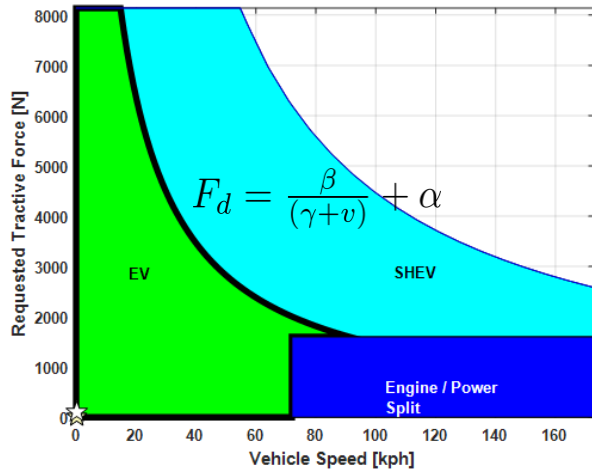

3.42:1

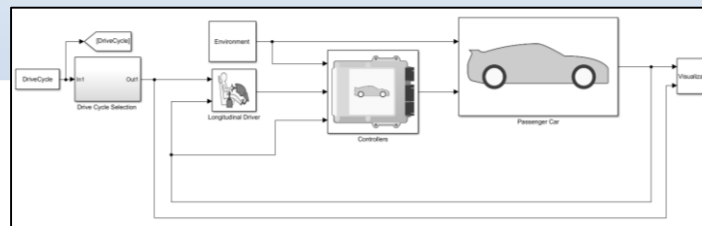
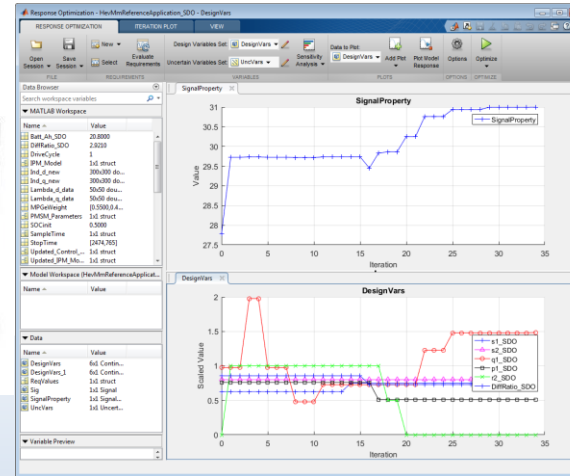

~ 12 Hours

+ 2% MPGe

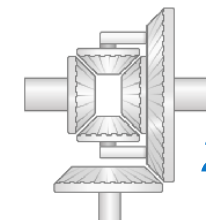
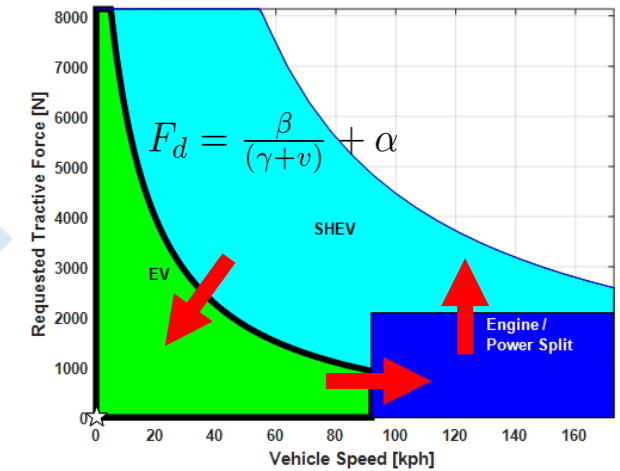

2.92:1

Design optimization studies

- Define Design Optimization studies with minimal setup effort
- Enable parallel computing with a simple checkbox
- Perform Design Optimization studies overnight on your laptop

How cool is that?



Agenda

- Introduction to Powertrain Blockset
- Five cool things you can do with it:
 1. Engine control design / calibration
 2. Fuel economy sensitivity
 3. Design optimization studies
 4. **Multidomain simulation via Simscape** → **Validate detailed subsystem design**
 5. Hardware-in-the-loop (HIL) testing

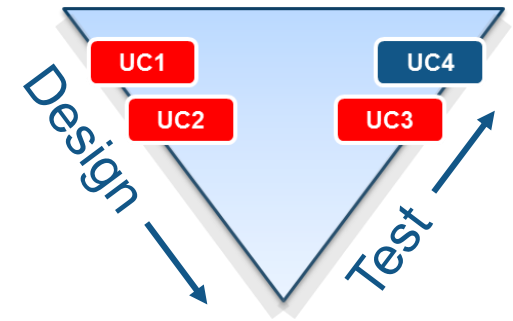

Custom Drivetrain or Transmission

- Replace portions of reference application with custom models assembled from Simscape libraries
- Use Variant Subsystems to shift back and forth based on current simulation task

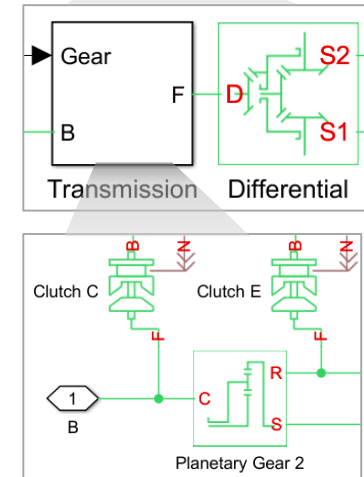
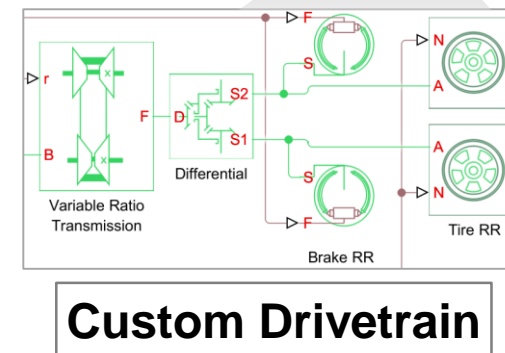
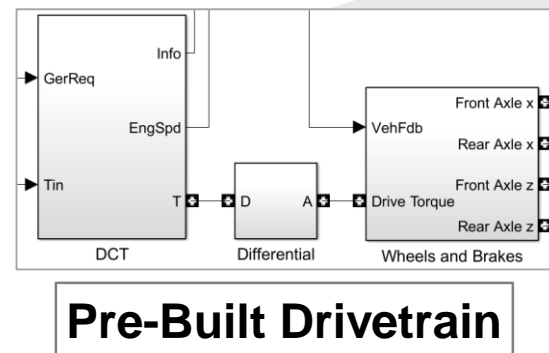
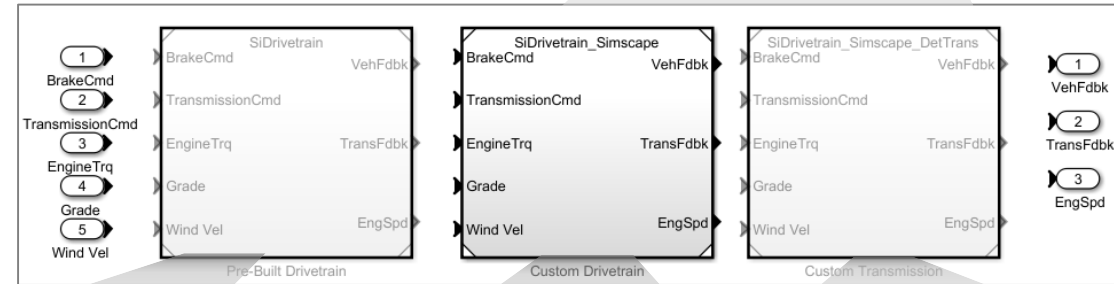
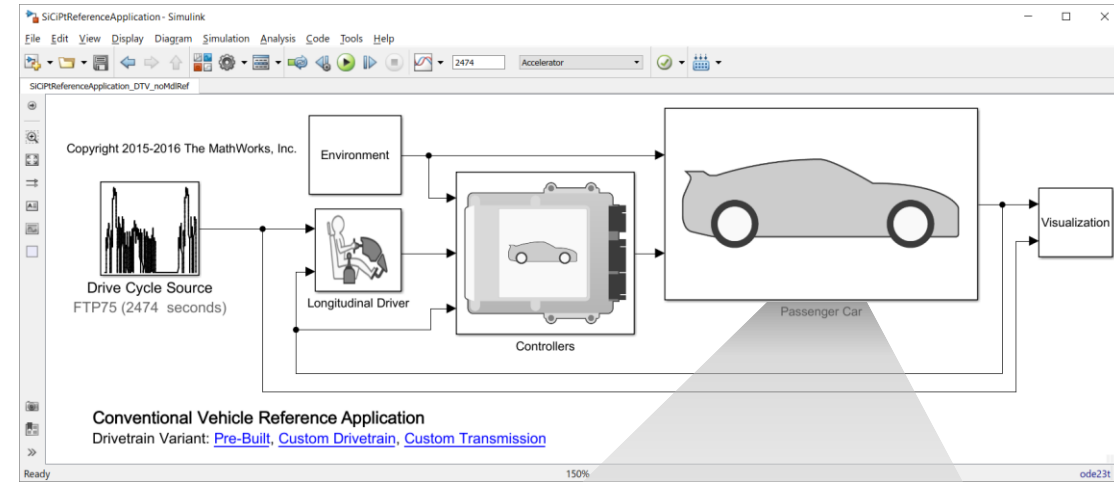

Engine Cooling System

- Take customization one step further
- Start with “Custom Driveline” variant
- Add Engine Cooling subsystem adapted from `sscfluids_engine_cooling_system`

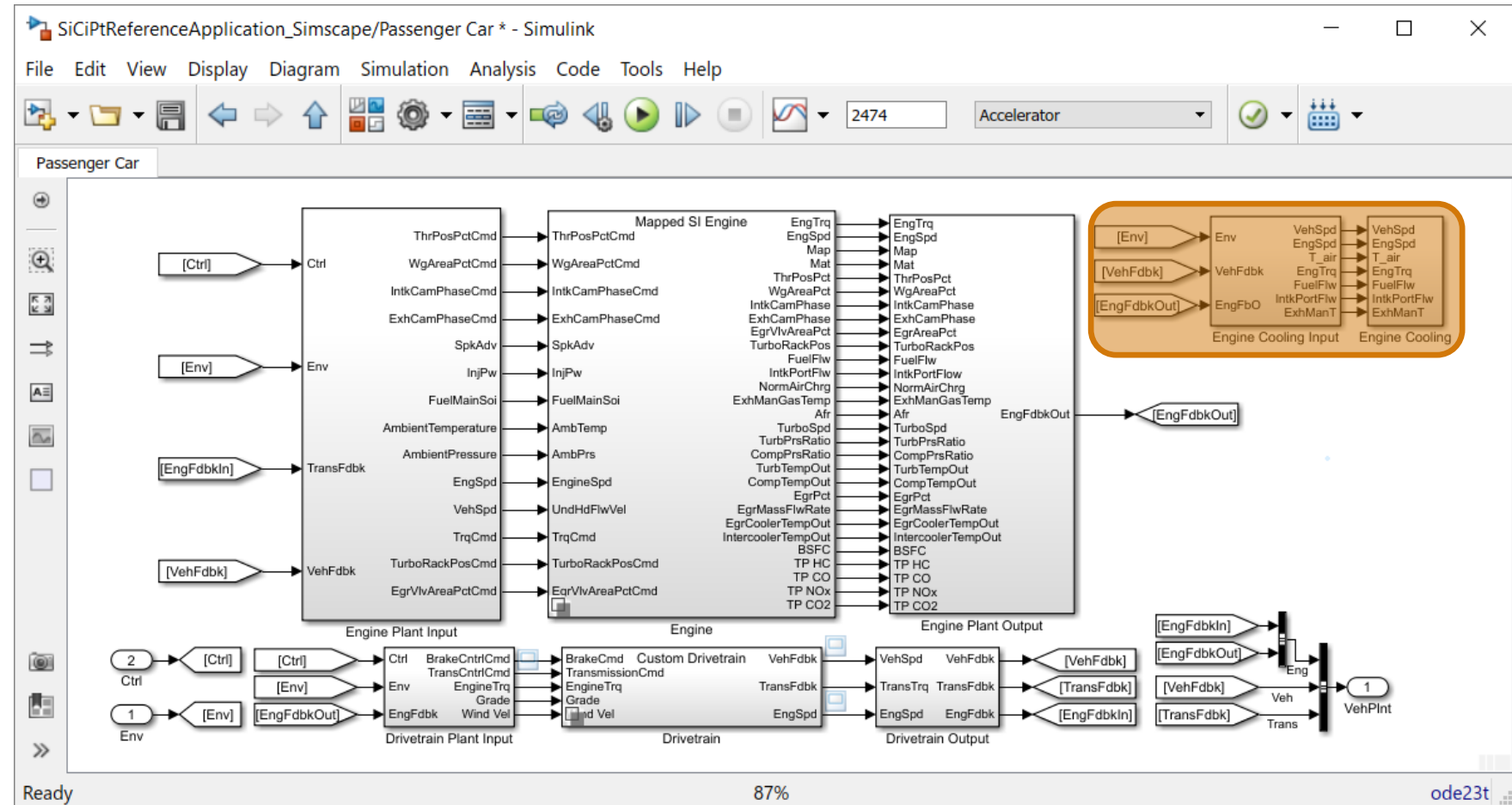

Conventional Vehicle with Simscape Engine Cooling

1. Heat rejection calculation
2. Heat distributed between oil and coolant
3. Temperature of cylinder used to validate cooling system performance

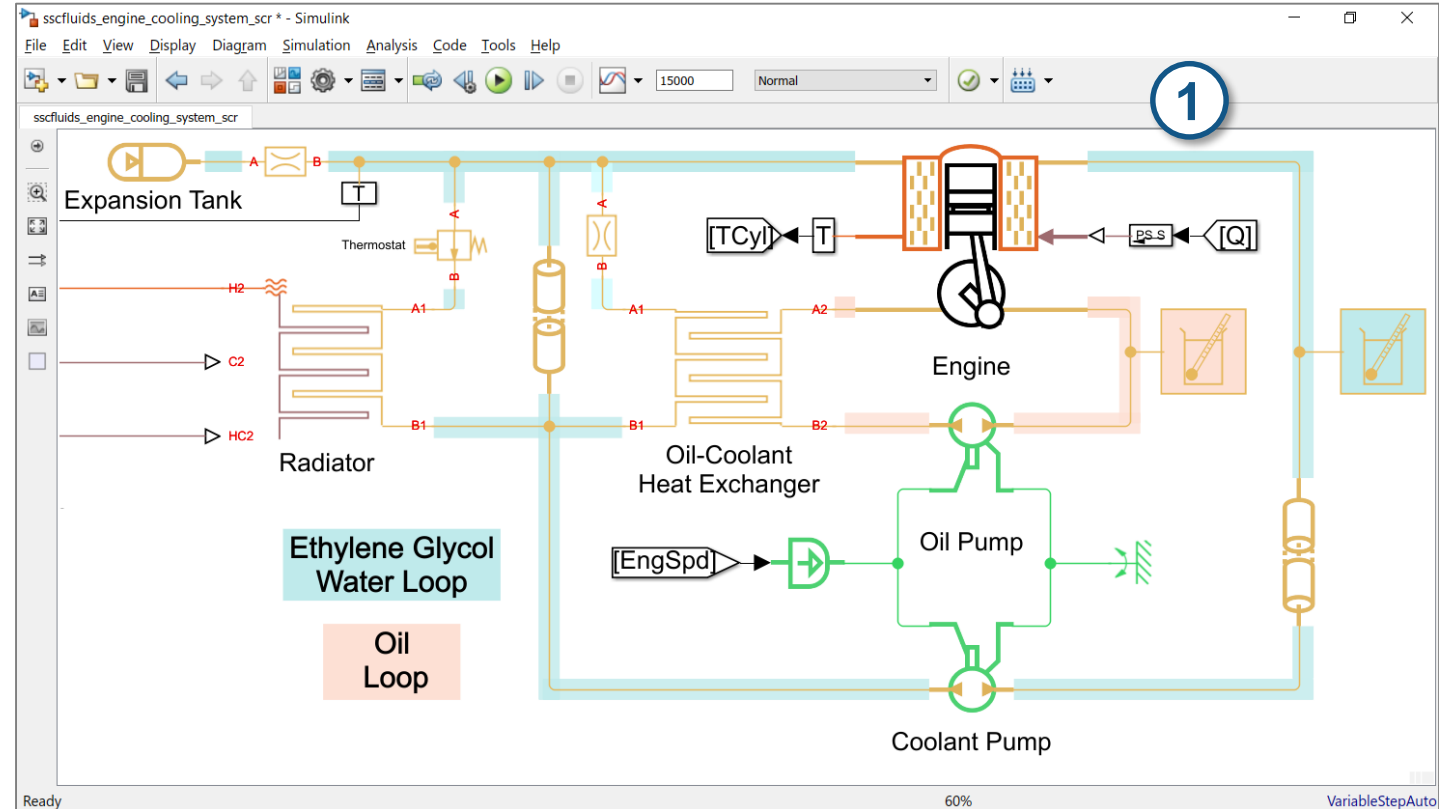

Local Solver enabled for faster simulation

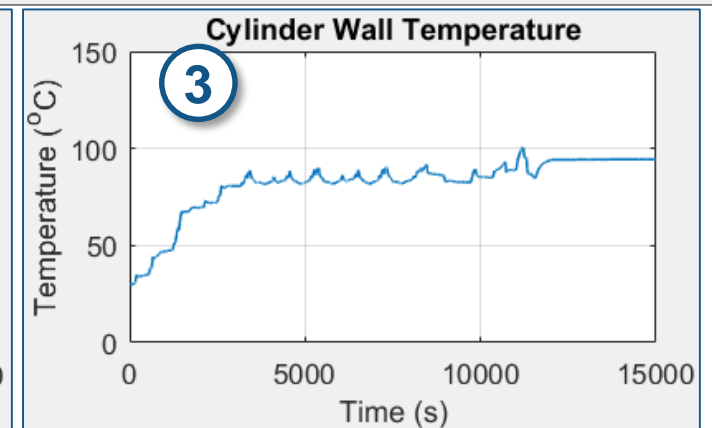
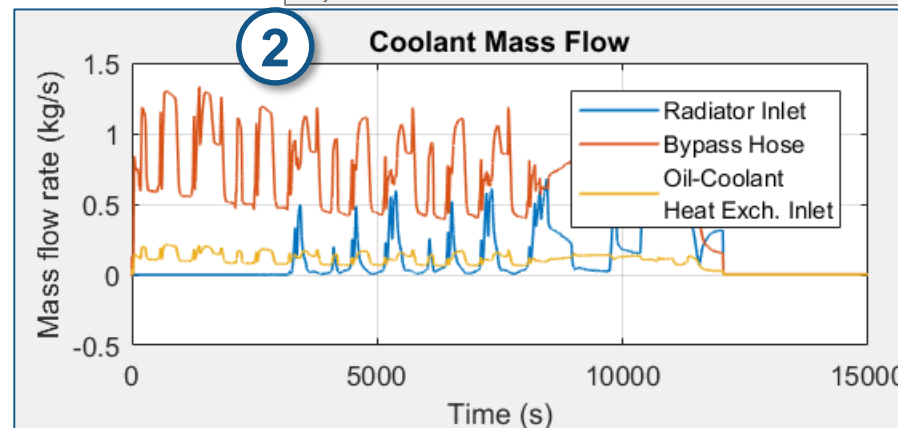

Multidomain simulation via Simscape

- Create detailed, multi-domain subsystem models with Simscape
- Incorporate them into system level vehicle models from Powertrain Blockset
- Validate subsystem performance with closed loop simulation

How cool is that?



Agenda

- Introduction to Powertrain Blockset
- Five cool things you can do with it:
 1. Engine control design / calibration
 2. Fuel economy sensitivity
 3. Design optimization studies
 4. Multidomain simulation via Simscape
 5. Hardware-in-the-loop (HIL) testing



Validate controller virtually

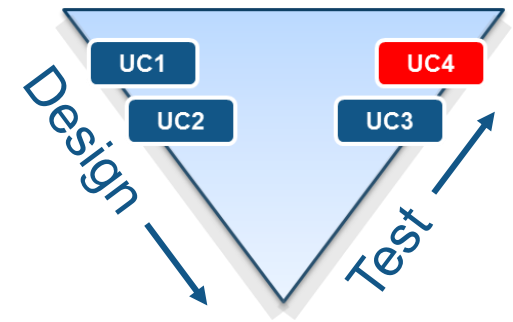

HIL Testing with Powertrain Blockset HEV Model

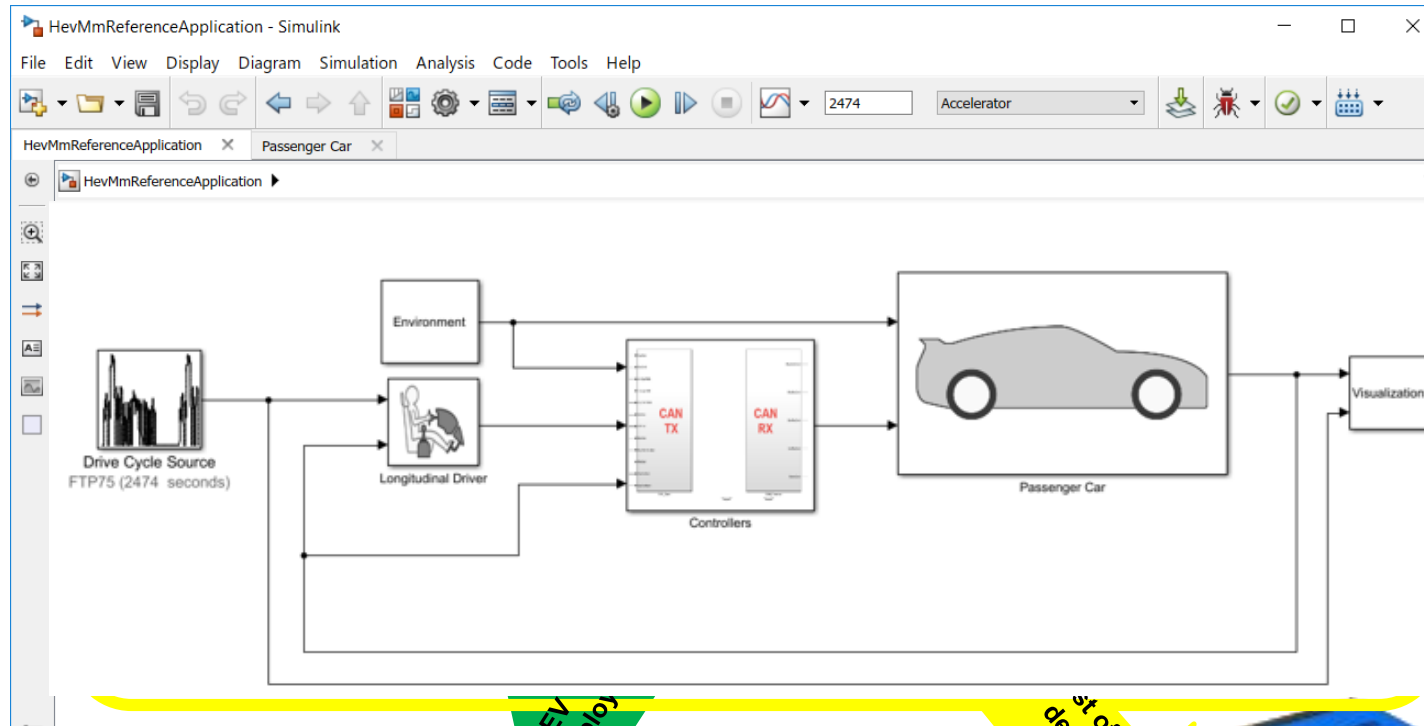

Speedgoat Rapid Control Prototyping System



Embedded Controller Hardware

HEV Deploy

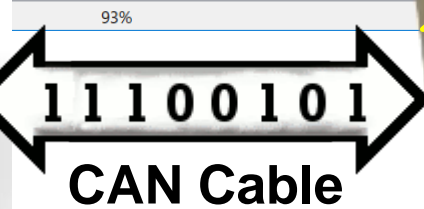

Target Computer Hardware

Model deployed to target

Speedgoat Hardware in-the-loop System

Easily Tune Parameters in Real Time and Save Calibrations

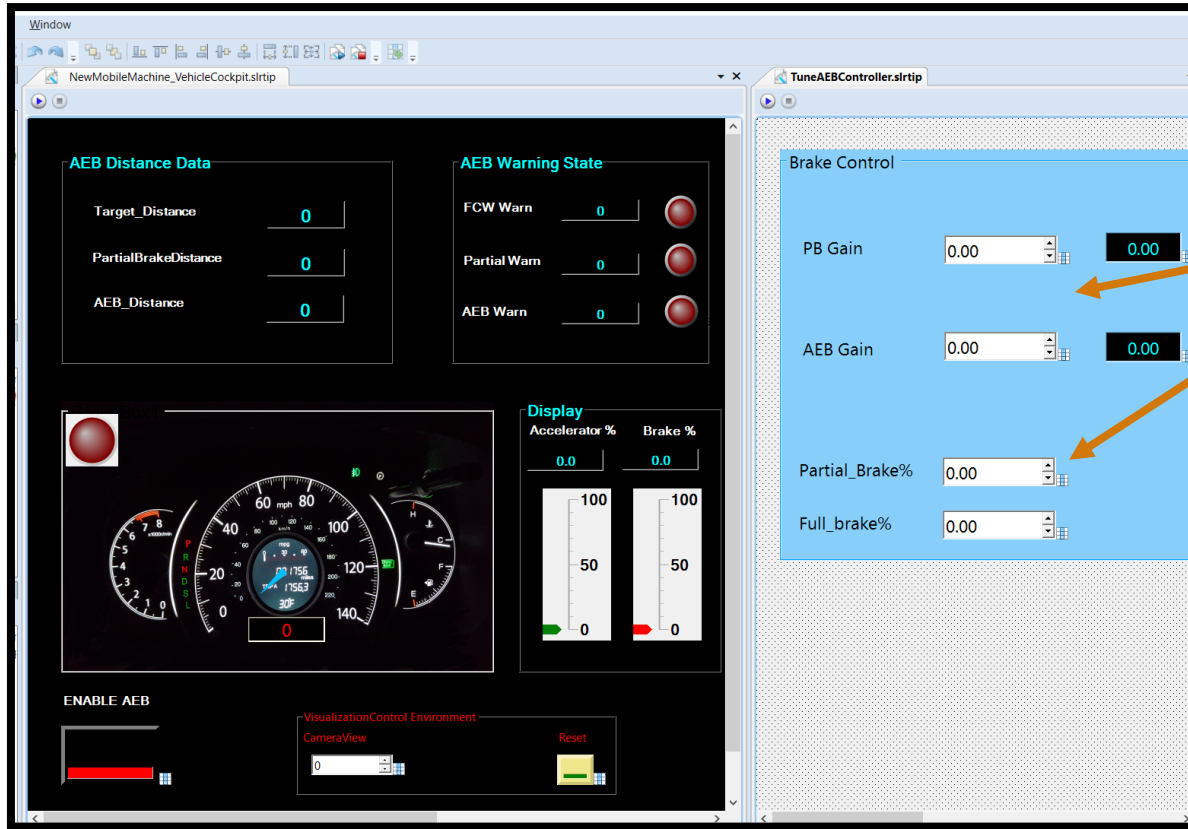

Calibrate parameters at run time in Simulink Real-Time Explorer

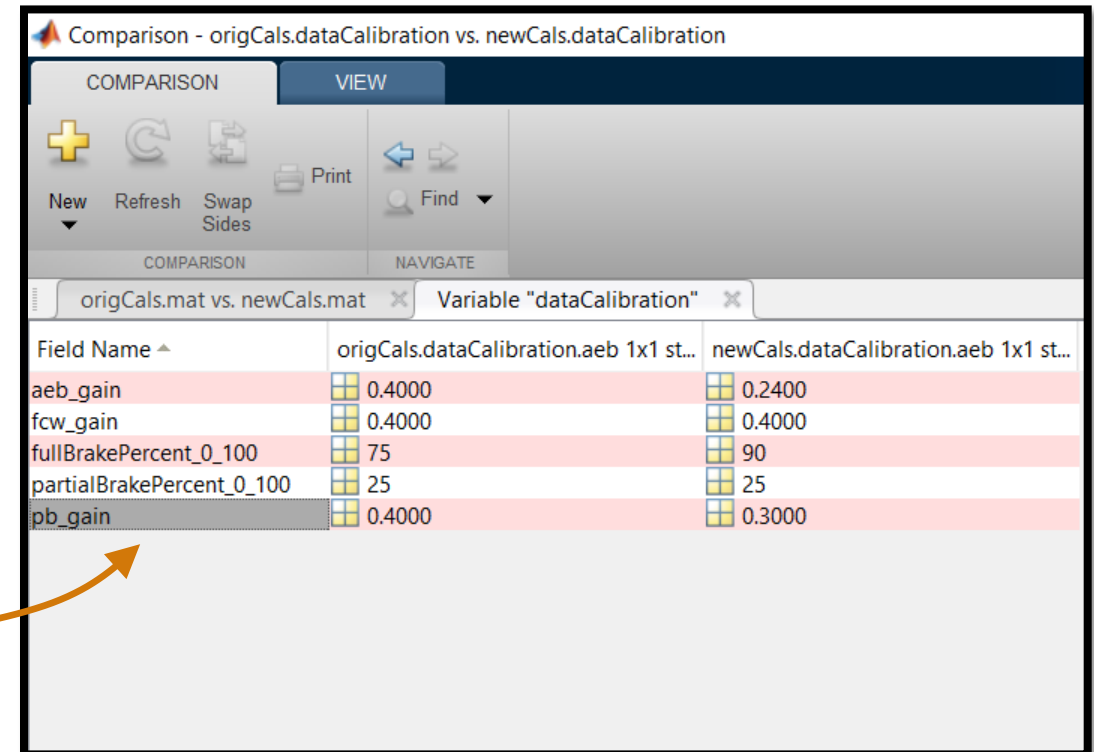

Use Simulink Real-Time API to save and compare calibrations directly from MATLAB

Hardware-in-the-loop (HIL) testing

- Validate control algorithm before physical prototypes are available
- Reuse the same vehicle models across the V-cycle
- Tune parameters in real time
- Setup a HIL test in a few hours

How cool is that?



Summary

- With Powertrain Blockset, you can perform Model-Based Design on your automotive systems with a single, seamlessly integrated environment
 - Engine control design / calibration
 - Fuel economy sensitivity
 - Design optimization studies
 - Multidomain simulation via Simscape
 - Hardware-in-the-loop (HIL) testing



If you'd like to learn more, please contact us!

Please send your questions to Mike Sasena at
mike.sasena@mathworks.com