

Electrified Powertrain Design Exploration

MathWorks Automotive Conference

May 2nd, 2018

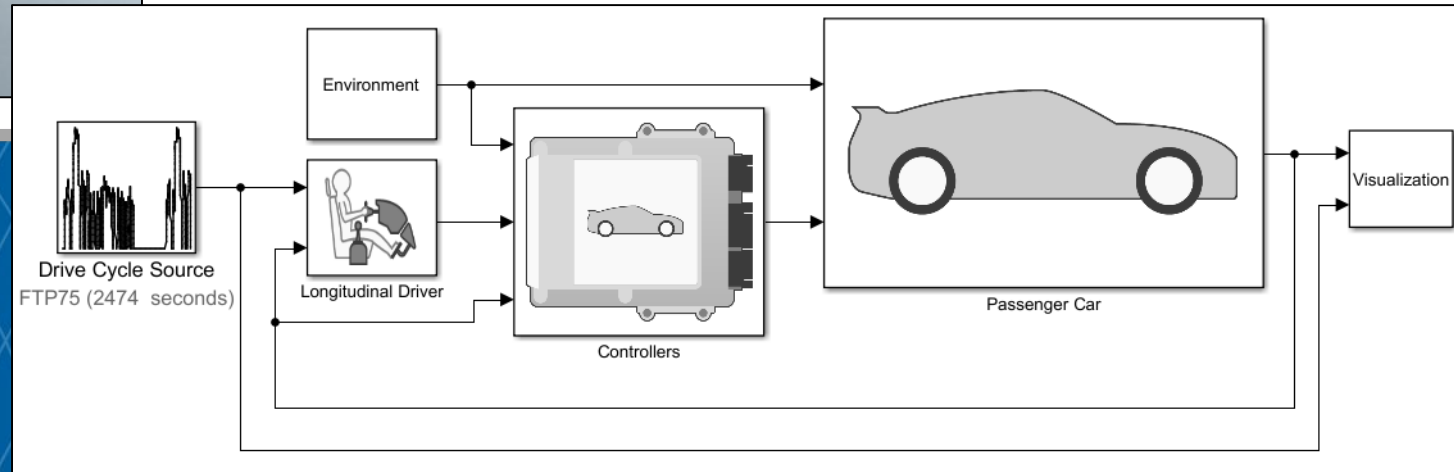
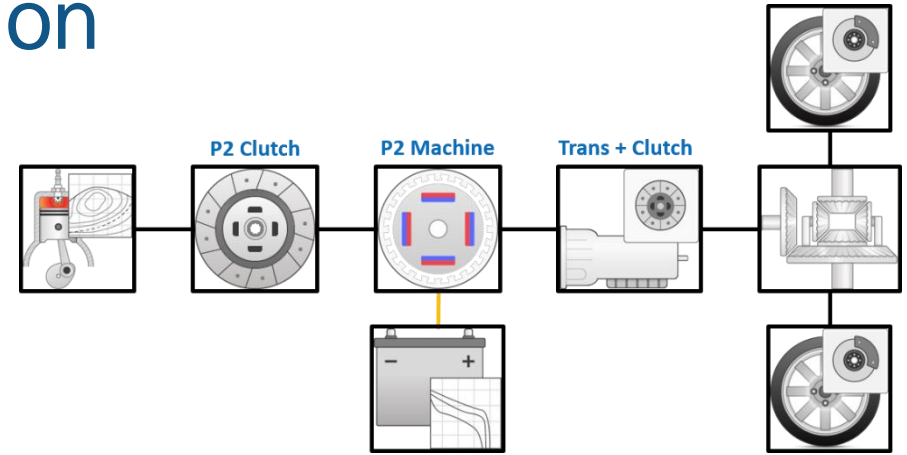
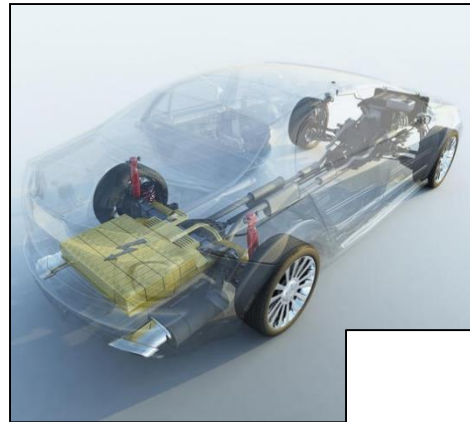

Kevin Oshiro
MathWorks

Presenter

- Kevin Oshiro
 - MathWorks Application Engineering

 - Areas of interest:
 - Enabling Model-Based Design using physical modeling
 - Mechatronic systems / electrified powertrains
 - System level control strategies
 - Mentor for EcoCAR3 student competition

 - Previous experience at PACCAR (Kenworth R&D),
Motorola

 - Education
 - MSEE, University of Washington
 - BSME, BSEE, Colorado School of Mines

Key Points

- Efficient **plant** modeling enables **Model-Based Design (MBD)**
- **Powertrain Blockset** provides HEV modeling **framework**, components, and **controls**
- **Design / optimize** plant and controls **together** as a system

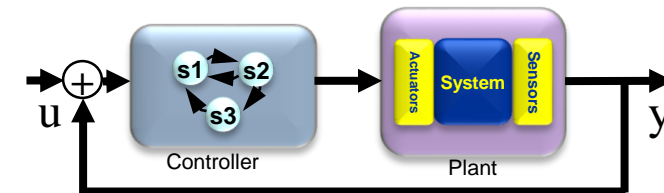
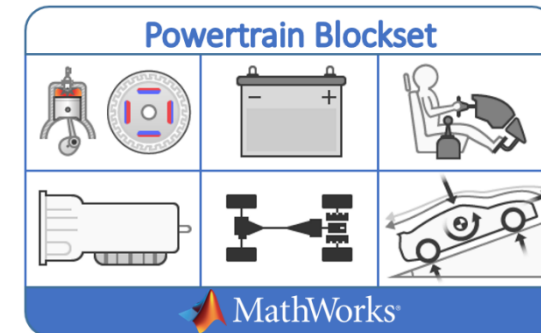
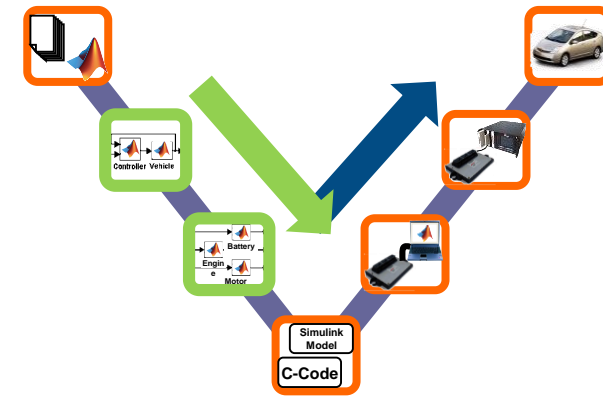

Agenda

1. Motivation for modeling HEV's
2. HEV plant modeling
3. Developing HEV controls
4. HEV design optimization

Agenda

1. Motivation for modeling HEV's
2. HEV plant modeling
3. Developing HEV controls
4. HEV design optimization

Challenges with HEV Design

- Architecture / topology selection
- Selection and sizing of components
- Complexities in modeling plant and controllers



- How to optimize performance over wide range of conditions?
- Control algorithms real-time implementable

Challenges with HEV Design – Example

- Parallel / Series-Parallel HEV Architecture
 - P# = Electric machine locations
 - Multiple combinations (i.e. P2, P1/P4, etc.)
 - Intrinsic pros/cons for each location

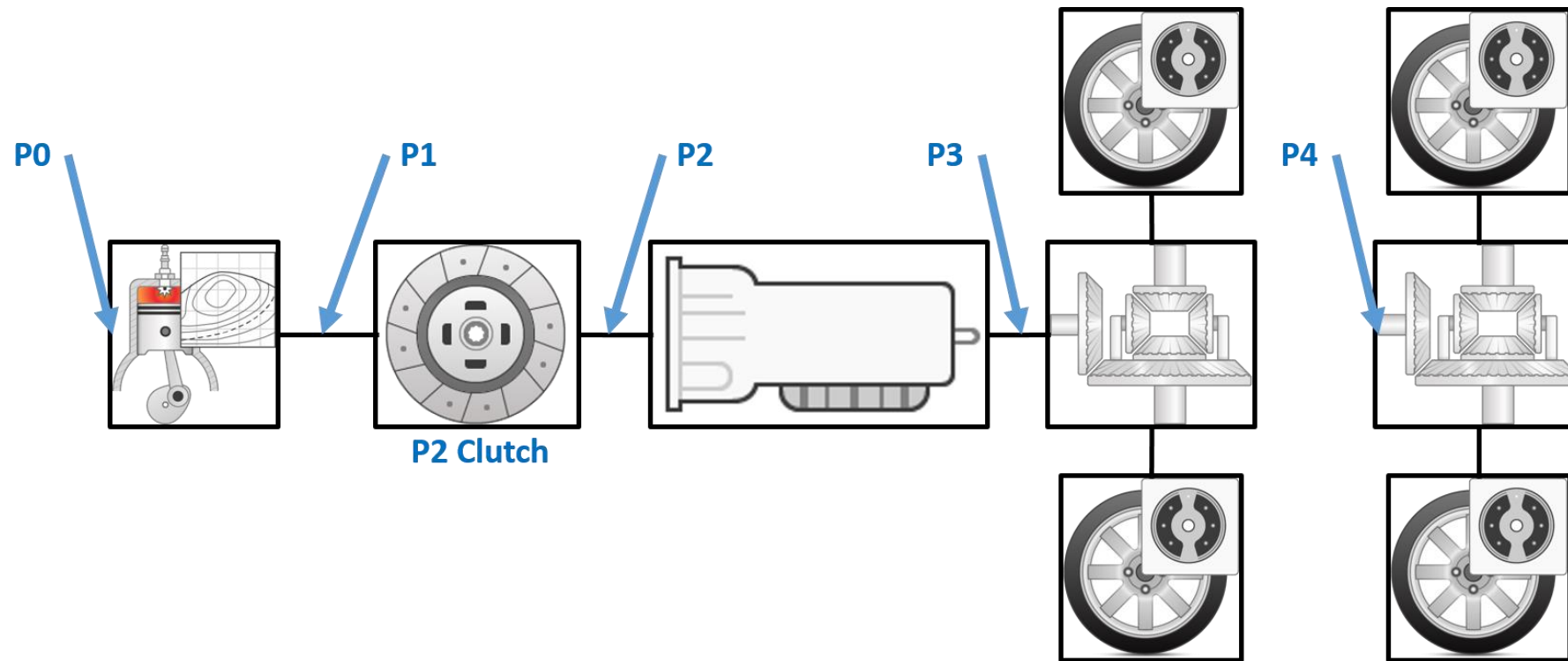

Challenges with HEV Design – Example

- Parallel / Series-Parallel HEV Architecture
 - P# = Electric machine locations
 - Multiple combinations (i.e. P2, P1/P4, etc.)
 - Intrinsic pros/cons for each location

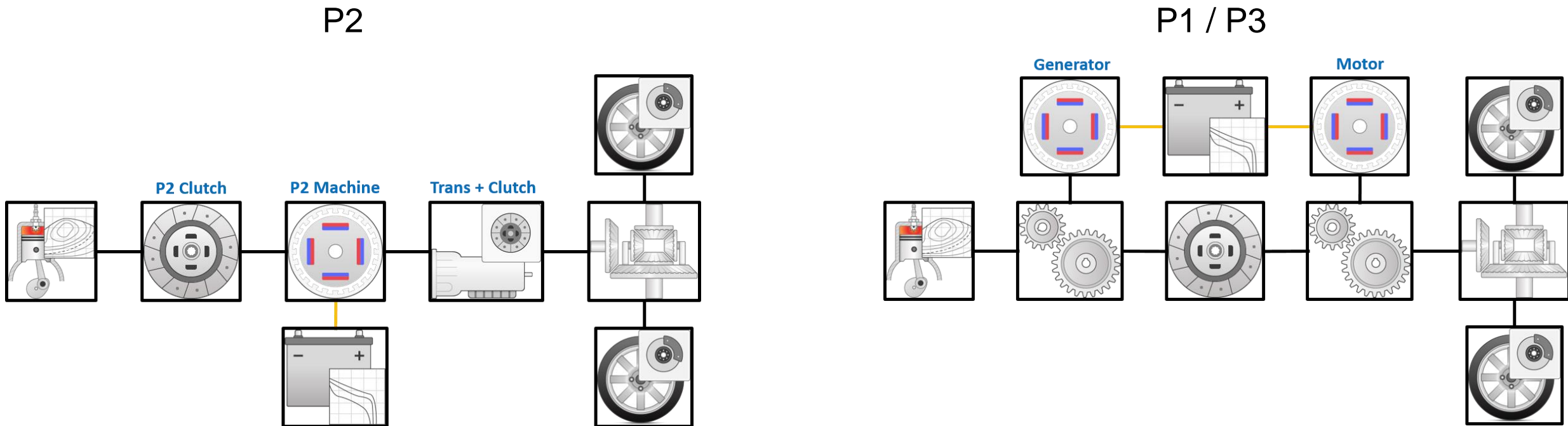

Challenges with HEV Design – Example

- How to optimize performance over wide range of conditions?
 - Reduce energy consumption
 - Driveability requirements
 - Acceleration time
 - Gradeability
 - ...

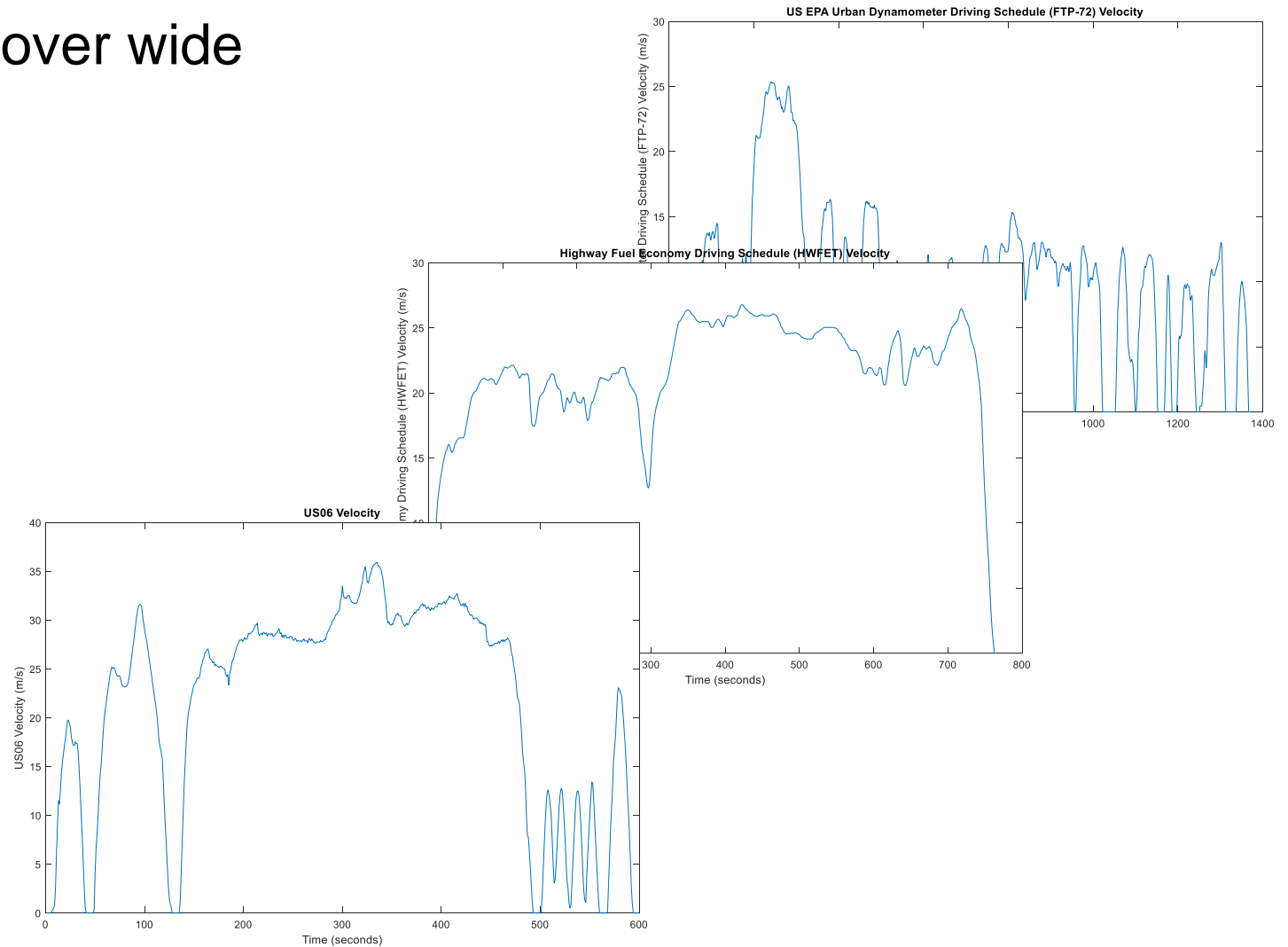

Solution – Model-Based Design (MBD)

- Sections 2, 3
 - Evaluate an architecture
 - Assess performance
 - Early closed loop control development

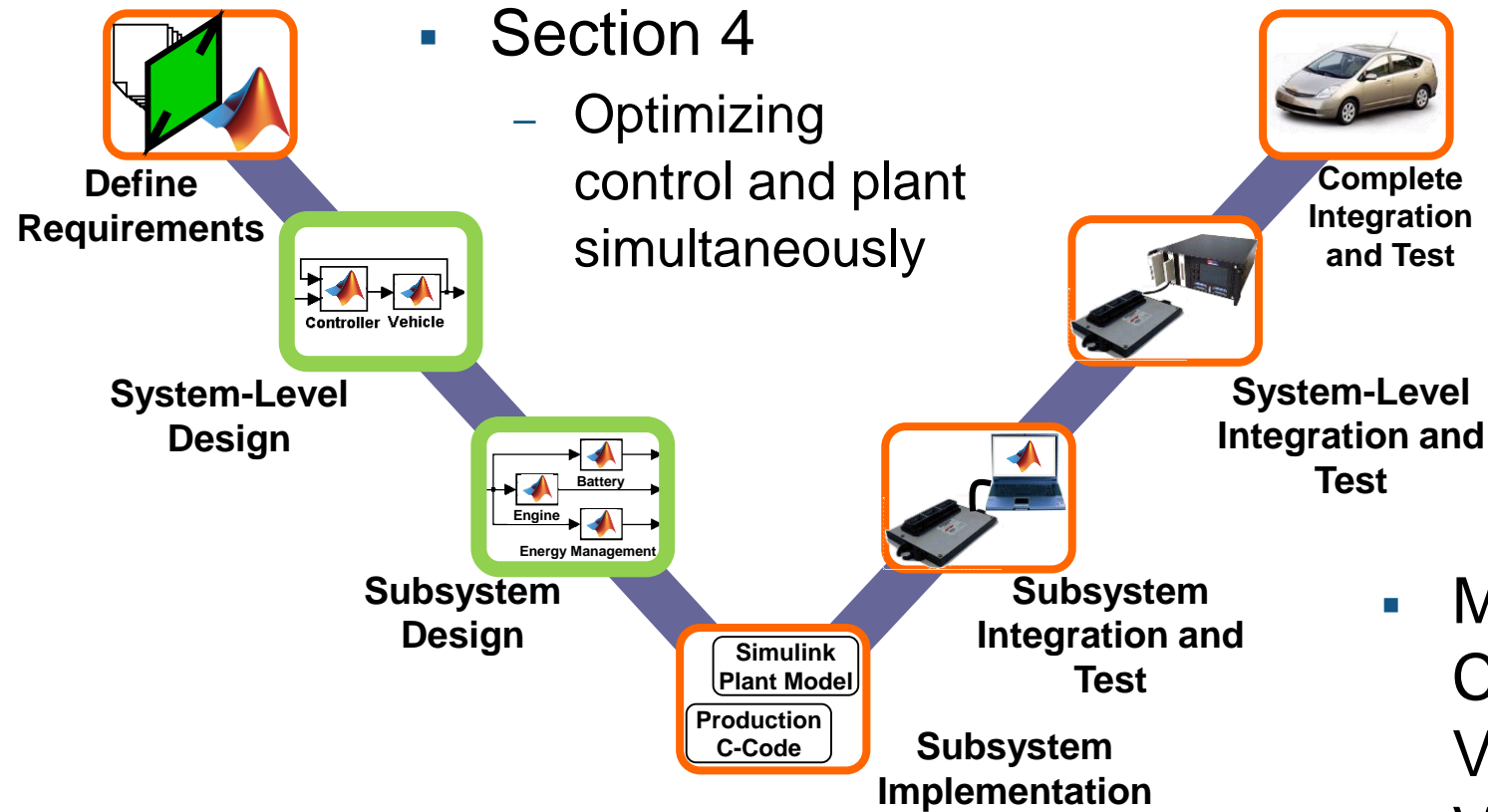

- Section 4
 - Optimizing control and plant simultaneously

- Model reuse - Code gen / HIL / Verification & Validation

Agenda

1. Motivation for modeling HEV's
2. **HEV plant modeling**
3. Developing HEV controls
4. HEV design optimization

Powertrain Blockset Features

Library of blocks

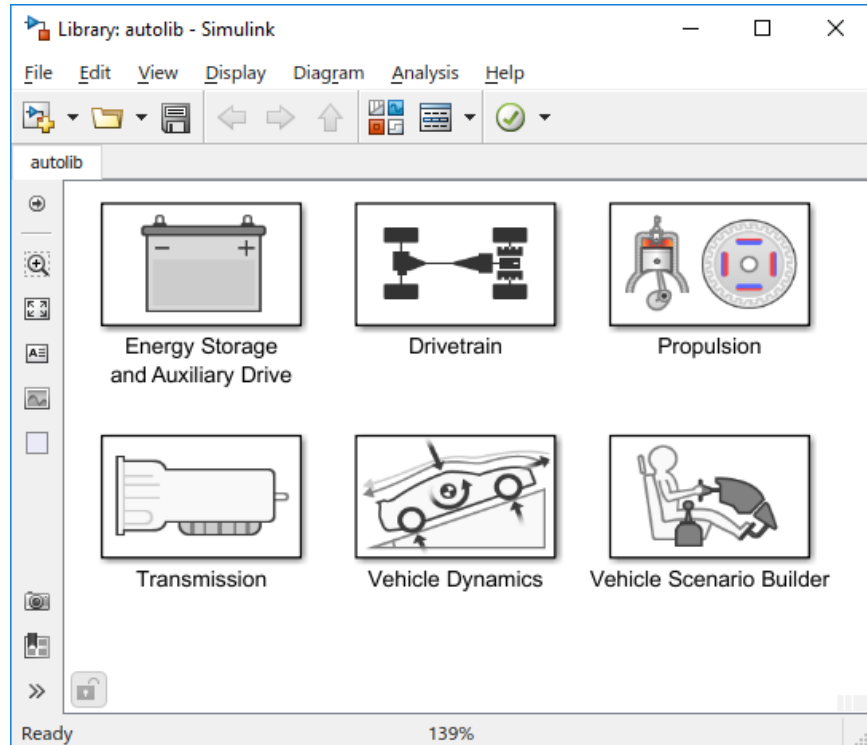

Pre-built reference applications

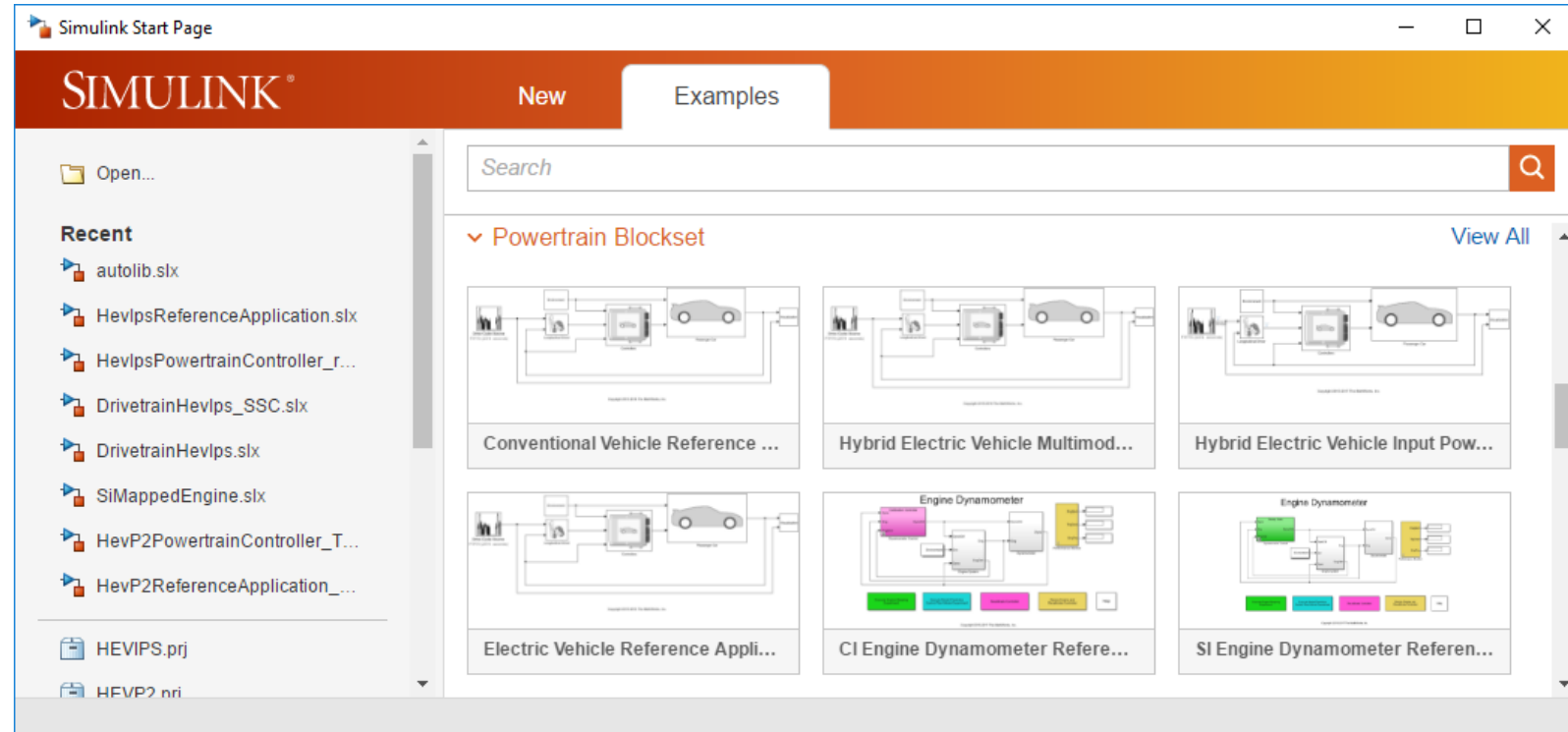

Powertrain Blockset Benefits

- Accelerate your system development process
 - Open and documented library of component and subsystem models
 - Pre-built vehicle models
 - Industry grade models / architecture
 - Parameterize / customize
 - Fast-running models that are ready for HIL deployment

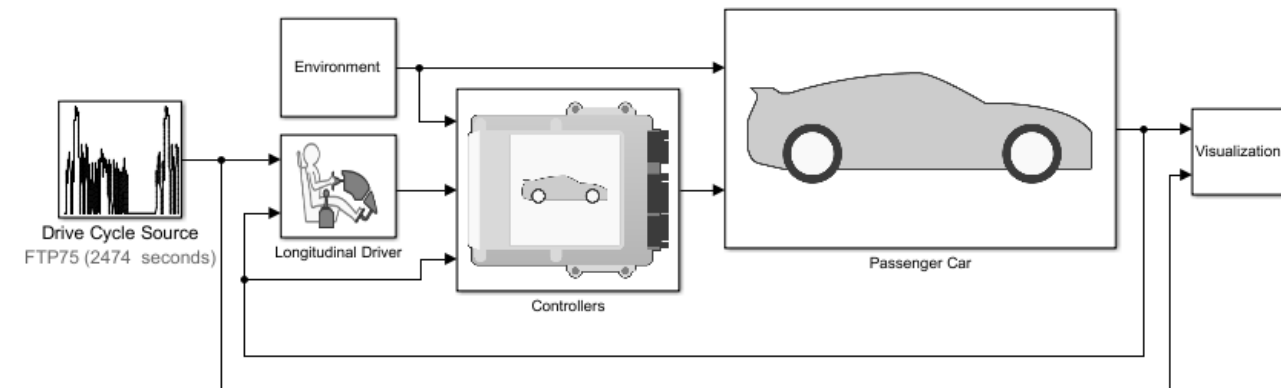
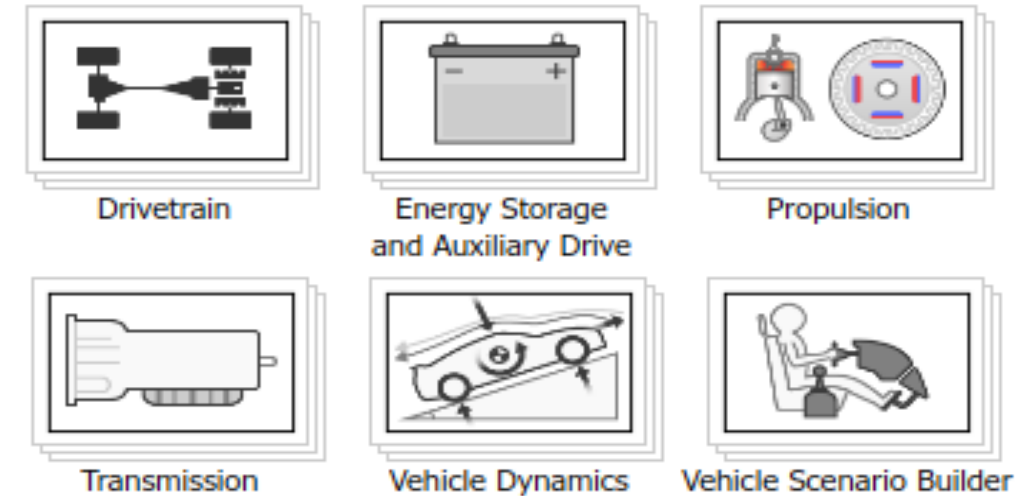

Powertrain Blockset – Engine Models

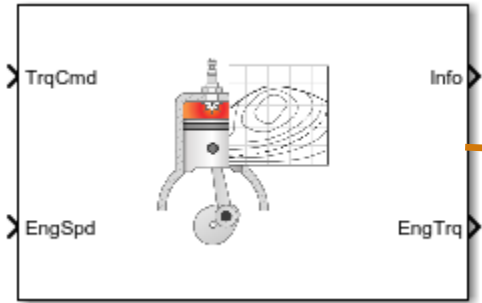

Use Powertrain Blockset *mapped* engine blocks with your own data

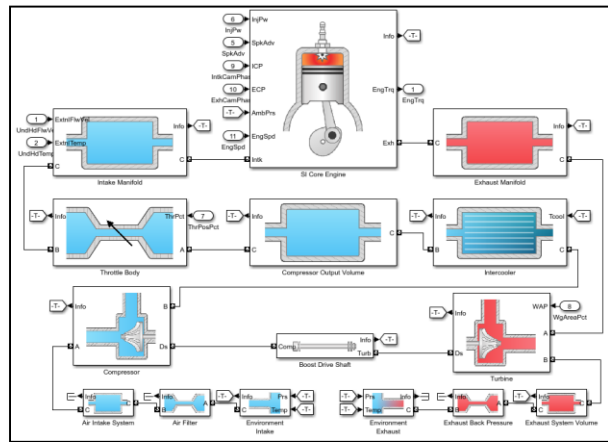

Create *dynamic* engine models using Powertrain Blockset library components

Engine Dynamometer

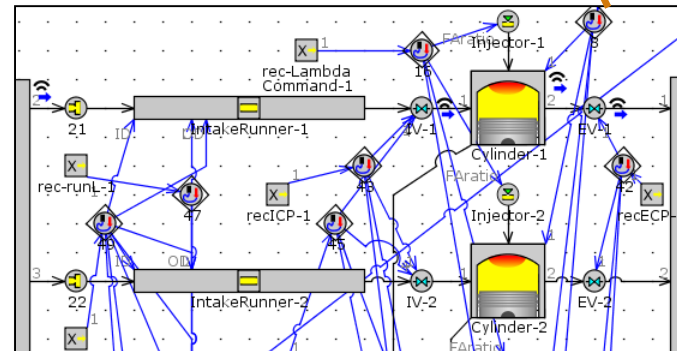
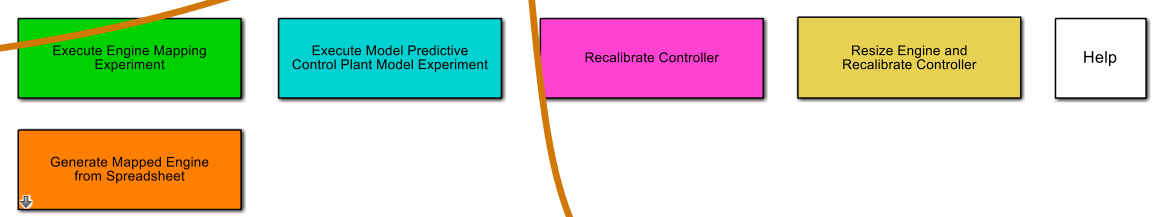
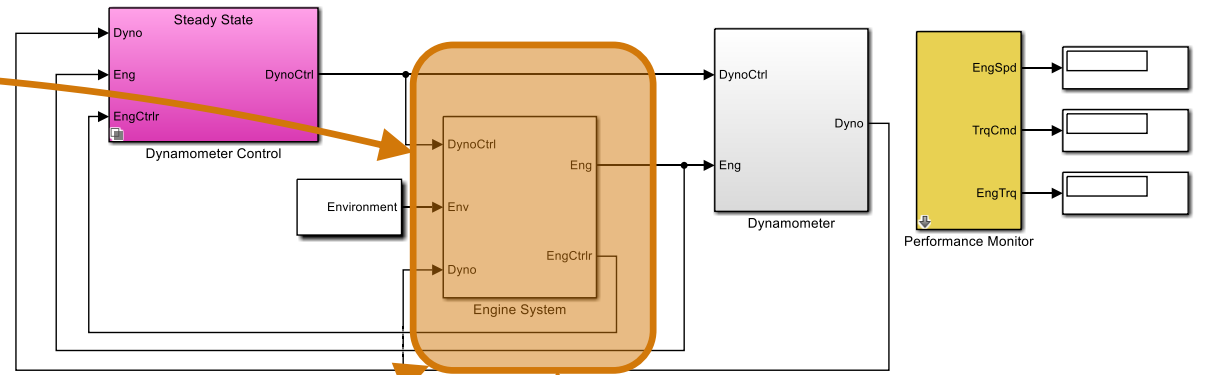

Connect in your own CAE model (e.g., GT-POWER)

Powertrain Blockset – P2 Reference Application

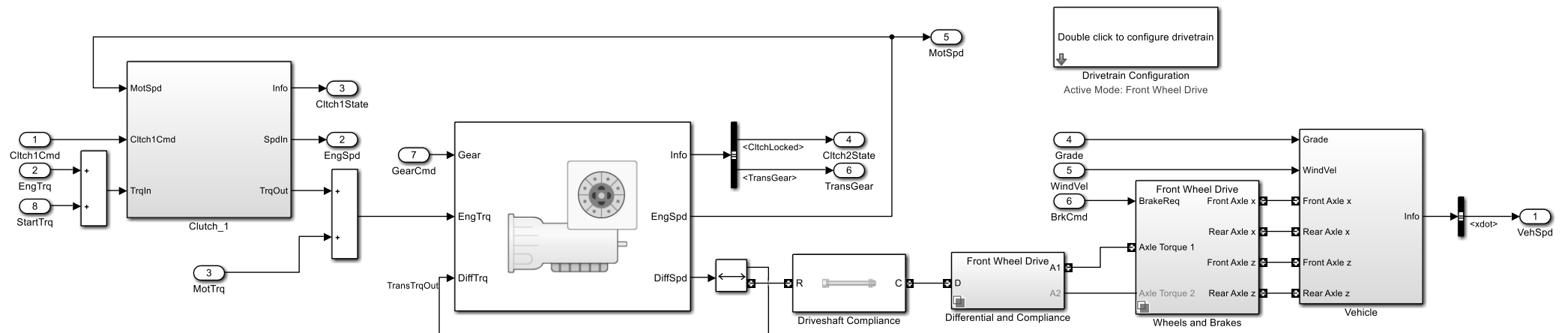
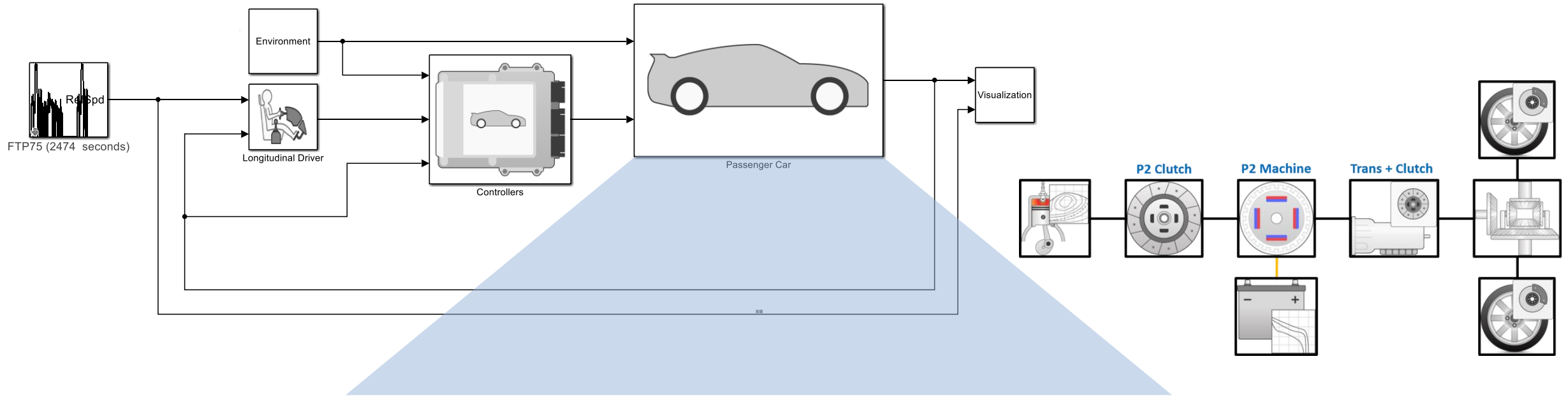

HEV Modeling Best Practices – Getting Started

- Start with a template or example
 - Review examples in Help for Powertrain Blockset (PTBS) and Simscape Driveline
- For system level simulation, start with a PTBS reference application
 - Model architecture
 - Uses referenced models and variant subsystems for modularity
 - Input / Output layers separate from application layer
 - Utilizes Simulink Projects for model organization
- Parameterize / customize subsystems for your needs

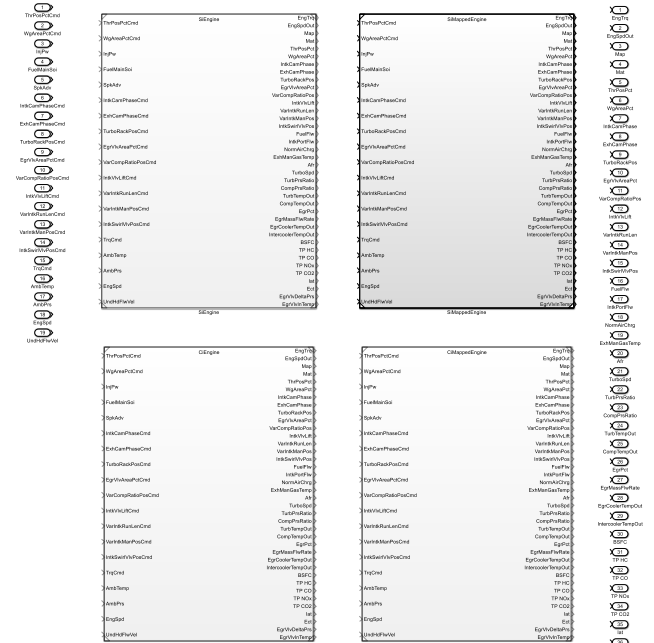
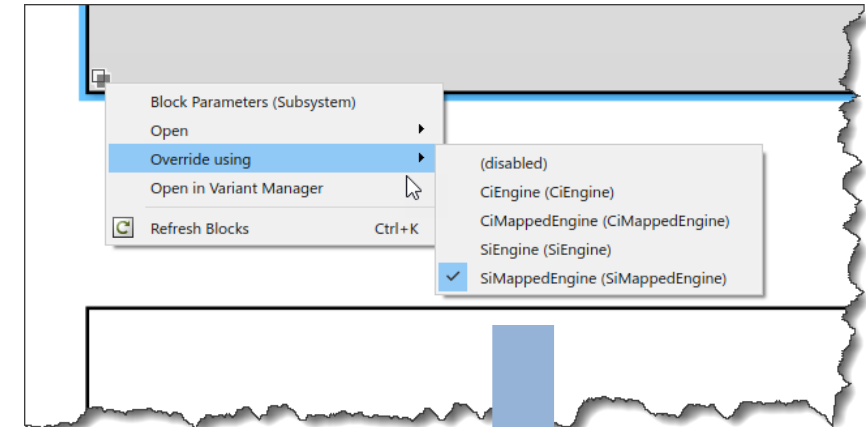

HEV Modeling Best Practices – New Models

- Use appropriate modeling fidelity for purpose

- Start small, build slowly, use “test harness” models
 - Ensure system is working properly before integrating into larger model
 - Can also use Simulink Test

- Use Simscape if:
 - Already have existing Simscape models
 - Multiple physical domains needed
 - Constructing complex topologies

Computational Time vs. Model Complexity

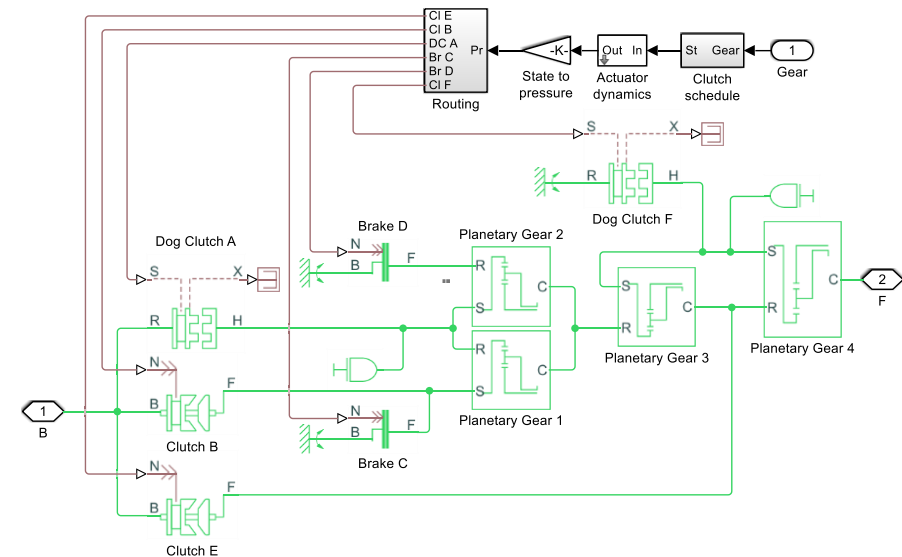
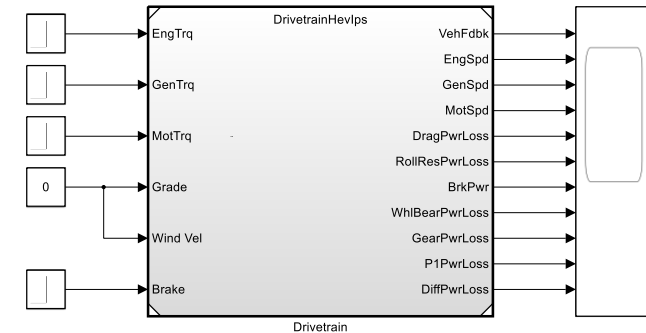
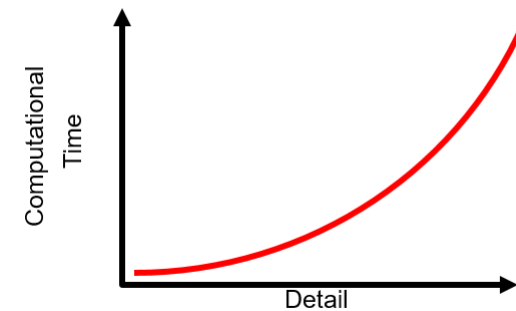

Key Points

- Efficient **plant** modeling enables **Model-Based Design (MBD)**
- Powertrain Blockset provides HEV modeling framework, components, and controls
- Design / optimize plant and controls together as a system

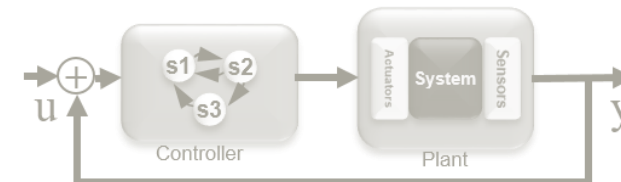
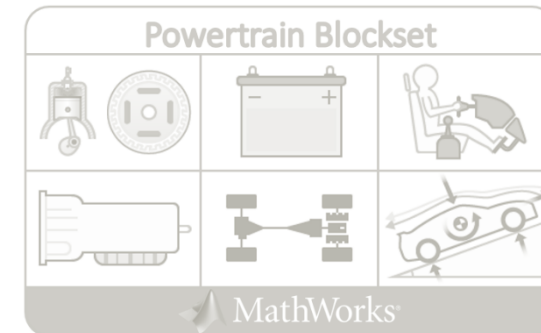
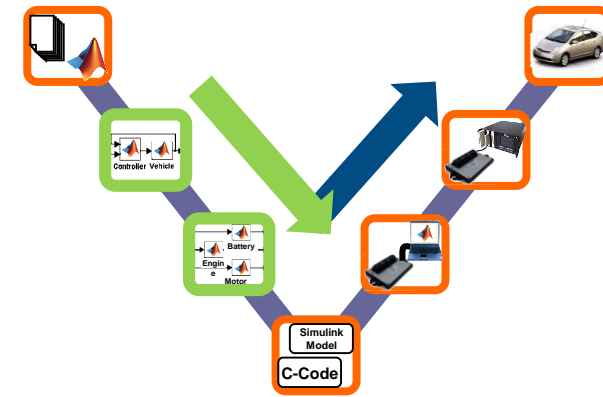

Agenda

1. Motivation for modeling HEV's
2. HEV plant modeling
3. **Developing HEV controls**
4. HEV design optimization

Powertrain Control – HEV Supervisory Control

- HEV system level controller included in Reference Applications
- Rule-based
- Simulink / Stateflow
- Real-time implementable
- Customize as needed

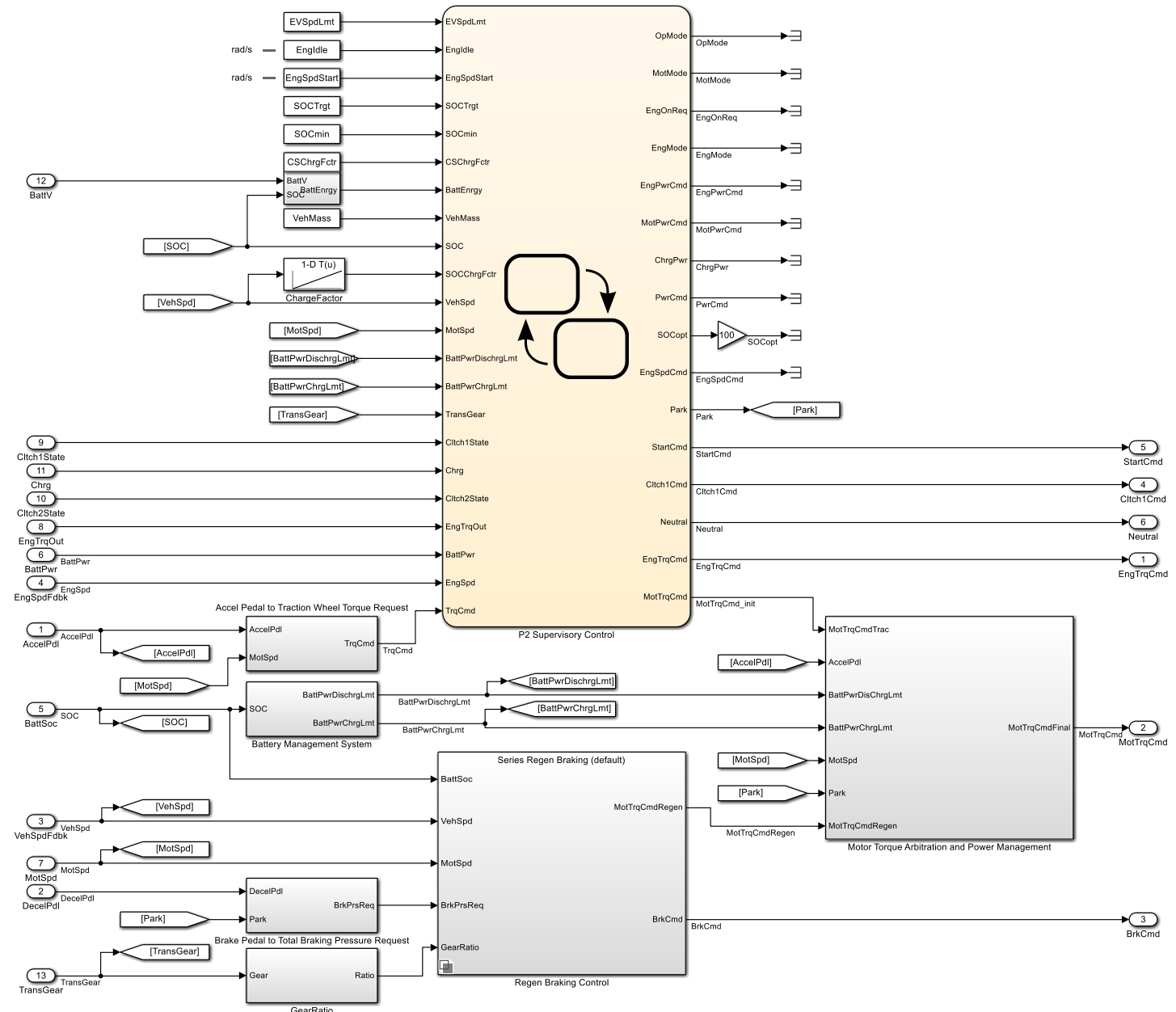

Powertrain Control – HEV Supervisory Control

Major Functions

- Accel Pedal → Torque
- Regenerative Brake Blending
- Battery Management System
- Power Management
- Supervisory Control (Stateflow)

Only supervisory control system changes for different HEV architectures

- Other functions are reusable

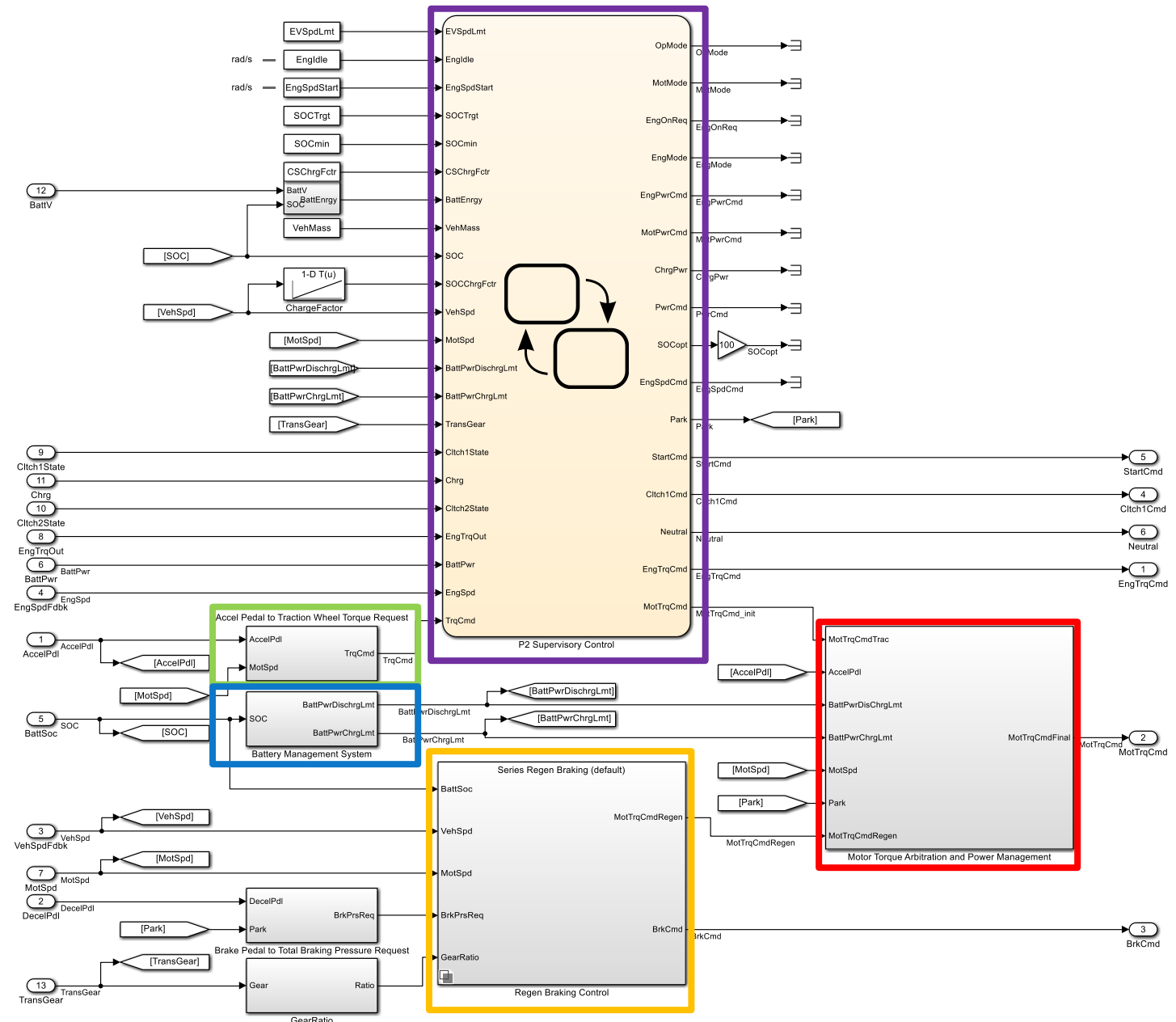

Powertrain Control – Charge Sustaining / PHEV Power-Split

SAE International

2011-01-2451
Published 06/01/2012
Copyright © 2012 SAE International
doi:10.4271/2011-01-2451
saealpov.saejournals.org

Optimization of Electrified Powertrains for City Cars

Andreas Balazs
Aachen Univ.

Edoardo Morra
Politecnico di Torino

Stefan Pischinger
FEV GmbH

– SOC Optimal calculation

$$SOC_{opt}^* = \frac{E_{batt} SOC_{opt} \eta_{rech} M_{veh} v_{veh}^2}{E_{batt}}$$

(2)

– Engine Power Calculation

$$P_{ICE,dem} = P_{dem,trac} + k_2 (SOC_{opt}^* - SOC_{act})$$

(3)

– Minimum Eng On Power

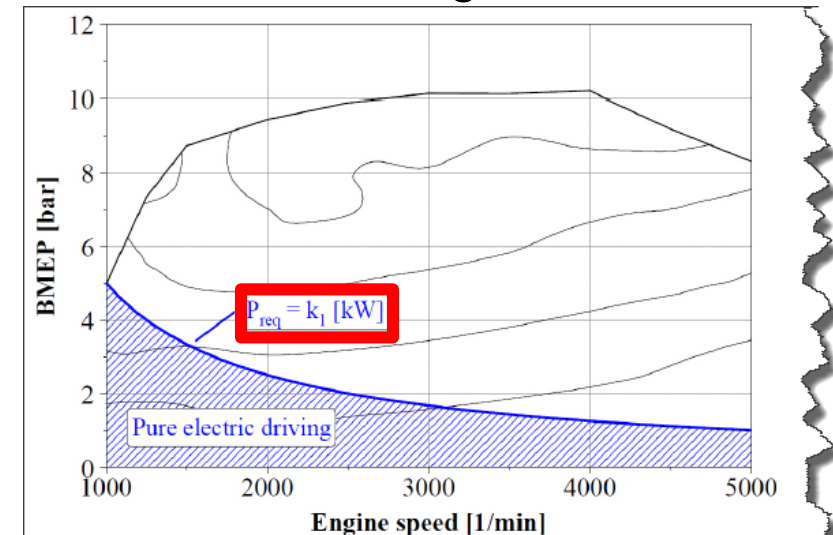
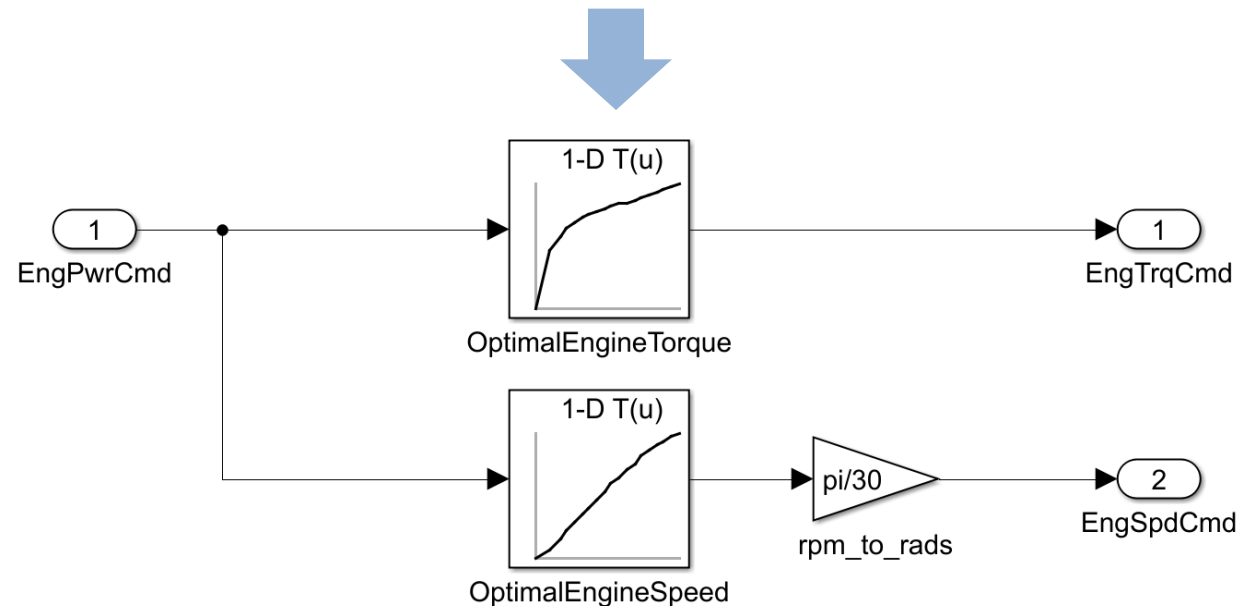
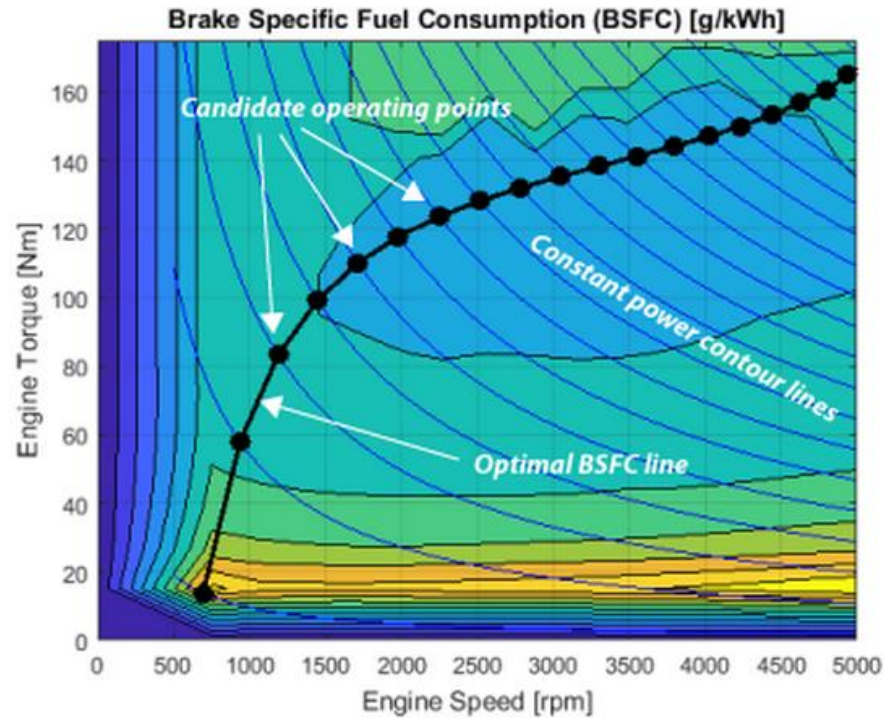

Figure 5. Hybrid operating strategy: parameter k_1

Engine Control – HEV Mode

- Optimization algorithm used to find minimum BSFC line
- Results placed in lookup tables
- For an engine power command
 - Stationary mode can operate directly on this line
 - PHEV mode will attempt to operate on this line
- Good example of combining optimization w/ rules



Powertrain Control – Power Management

- Bound battery power within dynamic power limits of battery
- Convert mechanical power request to electrical power using efficiency map
- Check if electric power request is within limits
 - OK → allow original mechanical power request
 - Not OK → use limit for electrical power, and convert to an allowable mechanical power request

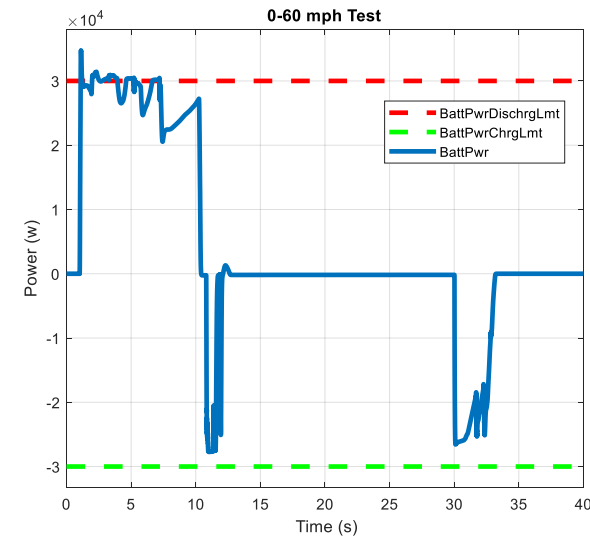
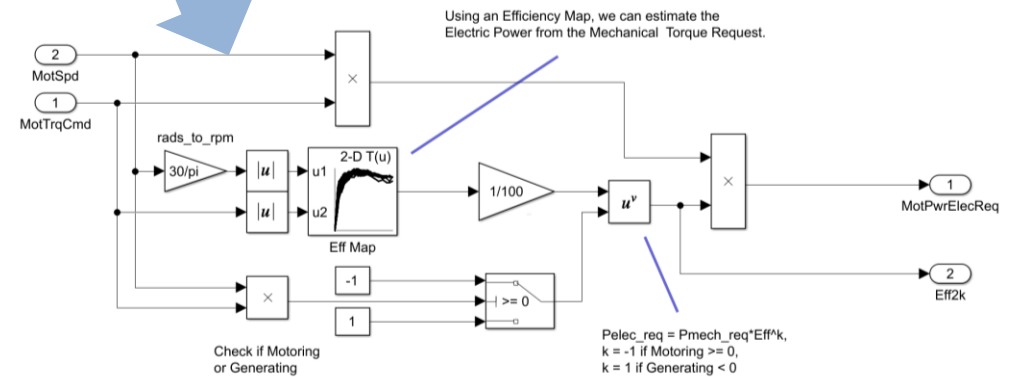
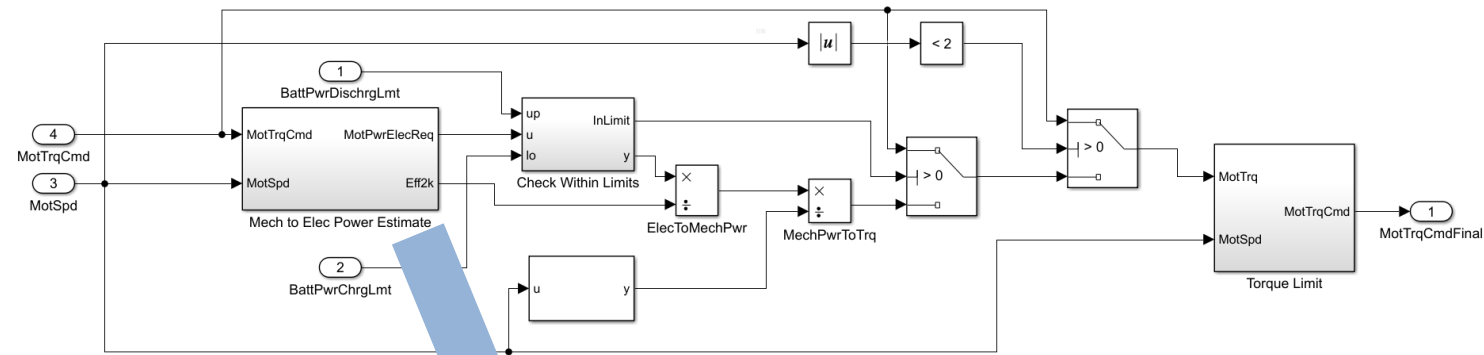

Starting the ICE in a P2 HEV: EV \rightarrow Parallel

- “Bump” start
 - Can cause driveline disturbance
- “Shuffle” clutches
 - Process takes \sim 400-500 ms, causes vehicle speed to decrease
- Use low voltage Starter (or P0 machine)
 - Implemented in P2 Reference Application
 - 12V starter cranks ICE \rightarrow ICE speed match mode \rightarrow close P2 clutch

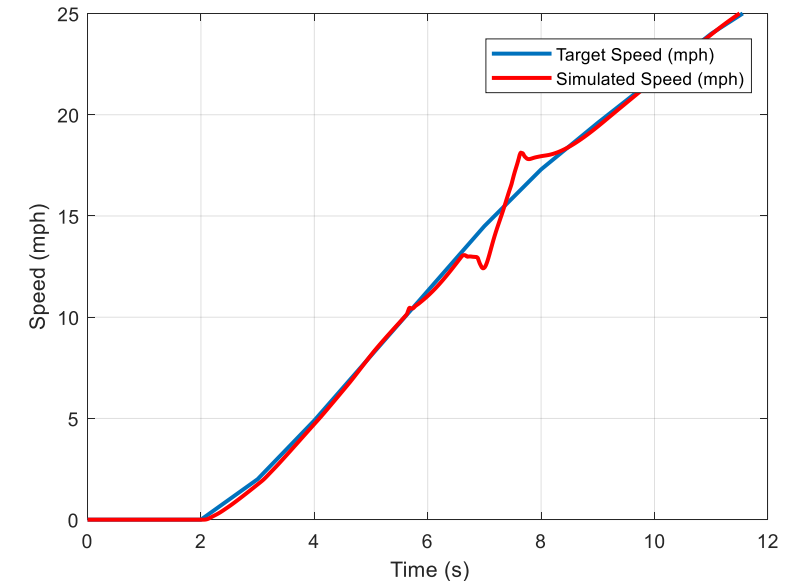
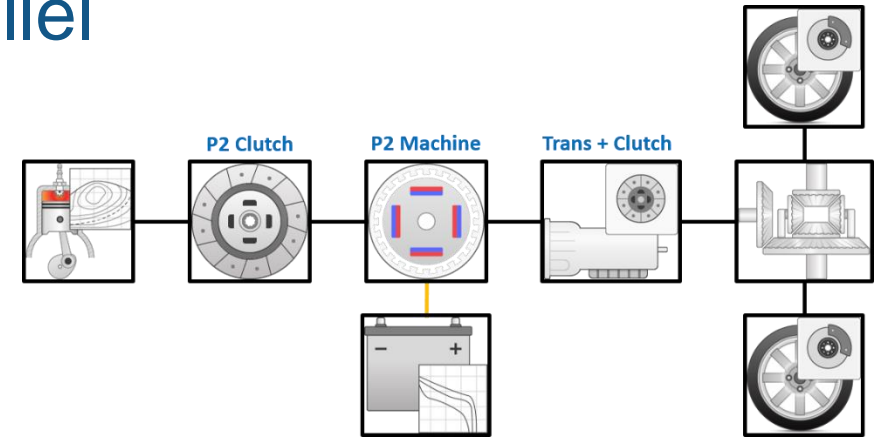

Assessing Performance

- Minimal vehicle speed tracking error
- Actuator torques not noisy
- Power doesn't exceed limits for long periods
- SOC trends toward target
- Improved MPG over conventional vehicle

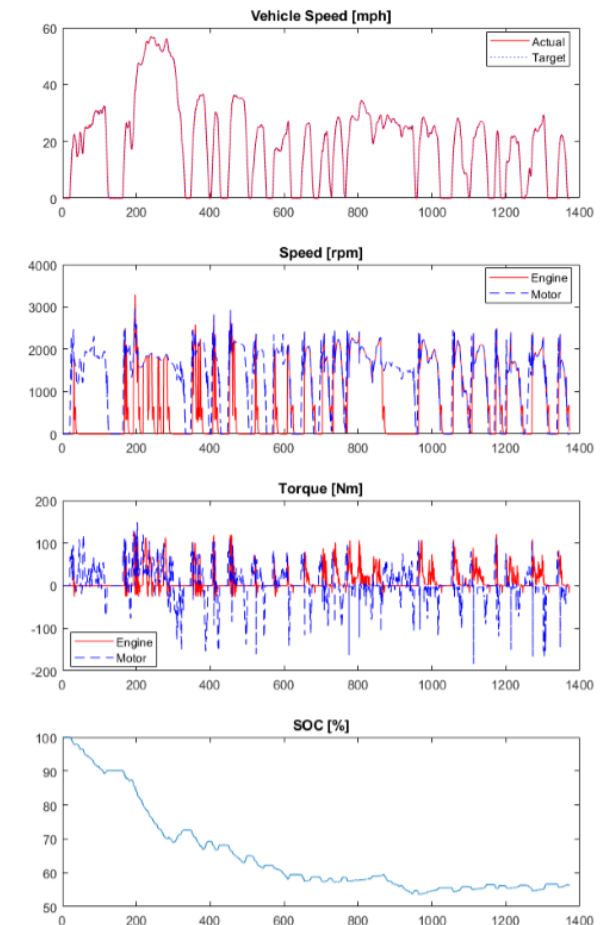
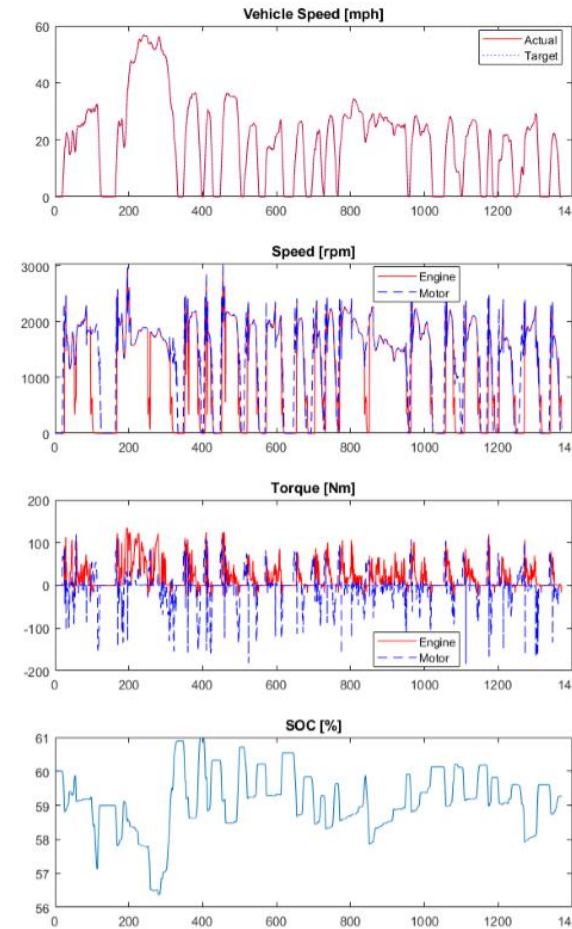
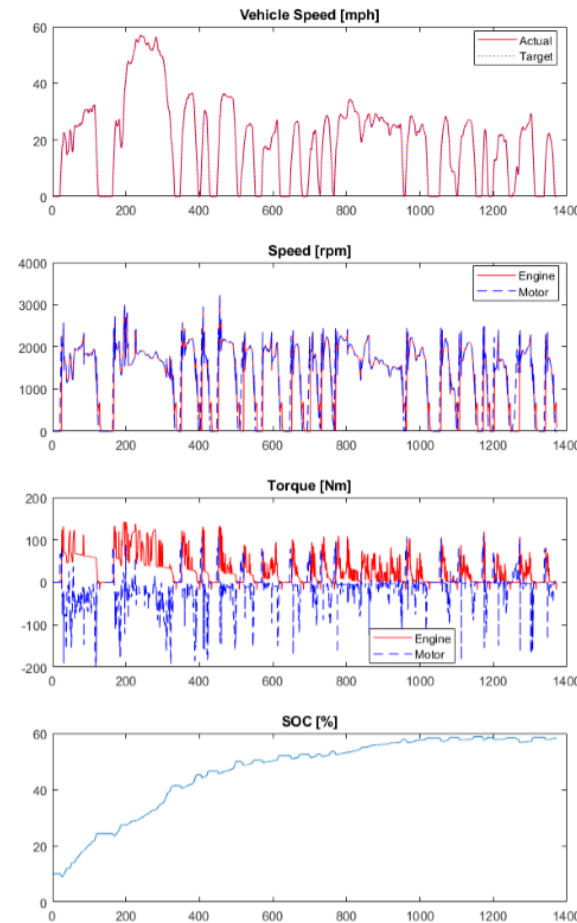

Key Points

- Efficient plant modeling enables Model-Based Design (MBD)
- Powertrain Blockset** provides HEV modeling framework, components, and controls
- Design / optimize plant and controls together as a system

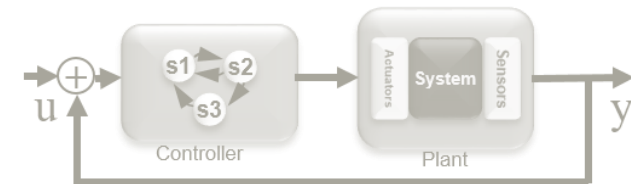
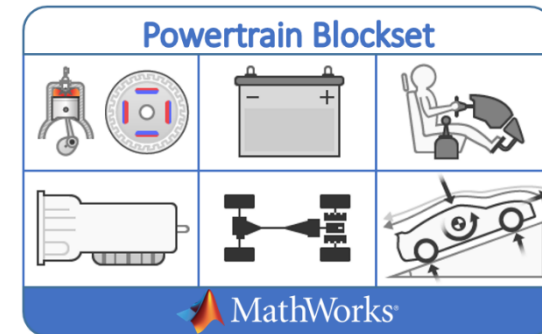
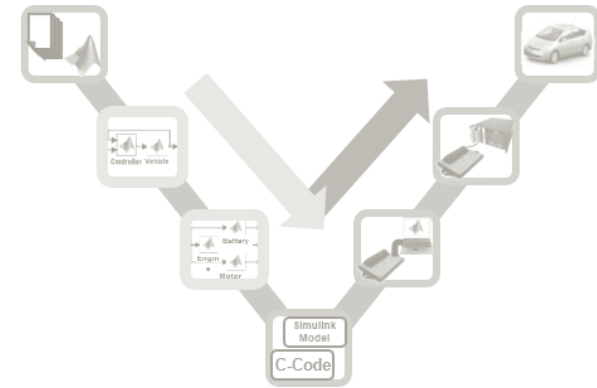

Agenda

1. Motivation for modeling HEV's
2. HEV plant modeling
3. Developing HEV controls
4. HEV design optimization

Optimization Introduction

- Objective function – What you are trying to achieve?
 - Minimize measured signal
- Design variables – What parameters need to be adjusted?
 - Physical model parameters
 - Controller gains
- Constraints – What are the bounds or constraints of the design variables?
 - Min/Max values
 - Parameter dependencies

Minimizing (or maximizing) objective function(s) subject to a set of constraints

Objective Function

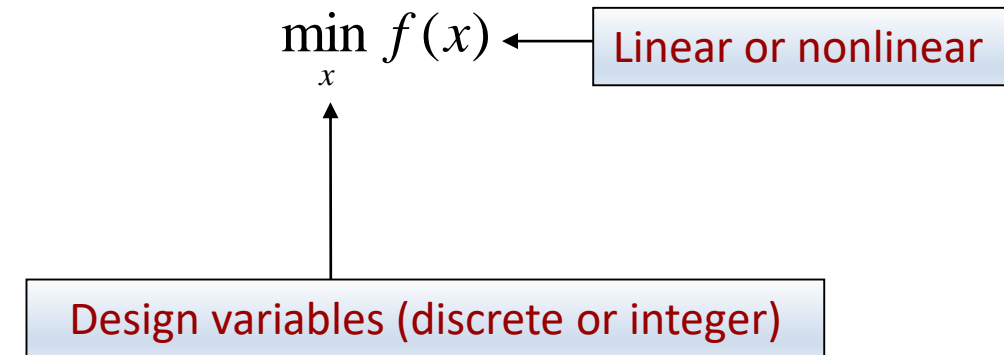

Linear constraints

$$Ax \leq b$$

$$A_{eq}x = b_{eq}$$

$$l \leq x \leq u$$

Nonlinear constraints

$$c(x) \leq 0$$

$$c_{eq}(x) = 0$$

MathWorks Optimization Tools

- [Optimization Toolbox](#)
 - MATLAB
- [Global Optimization Toolbox](#)
 - MATLAB
- [Simulink Design Optimization \(SDO\)](#)
 - **User Interface**
 - Uses functions from toolboxes above

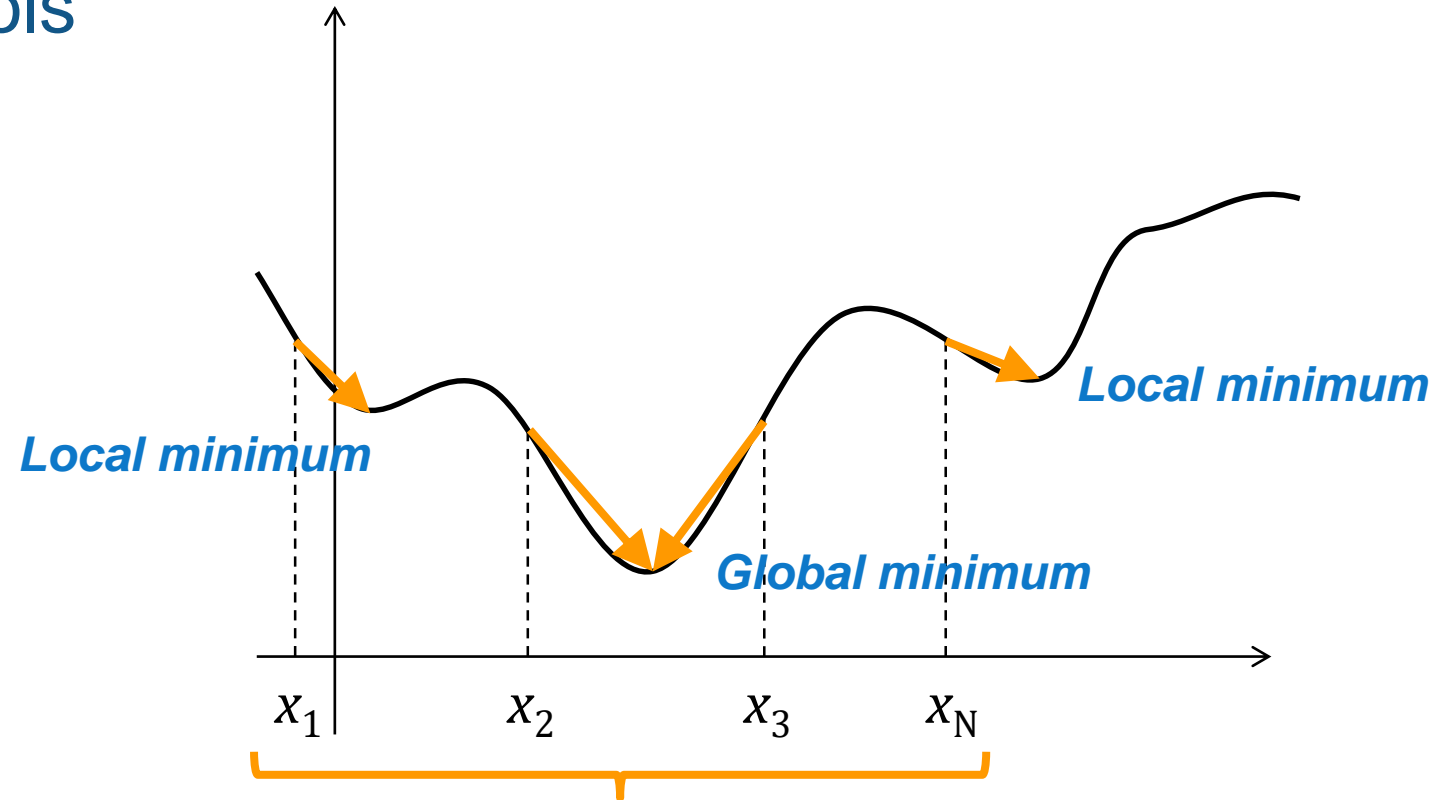

Different starting points give different optima!

HEV Design Optimization Examples

- Example 1
 - Simultaneous control and hardware parameter optimization

- Example 2
 - Find single set of control parameters that work for different driving conditions

HEV Design Optimization Examples

- Example 1
 - Simultaneous control and hardware parameter optimization

- Example 2
 - Find single set of control parameters that work for different driving conditions

Multi-Mode HEV Review

SAE International

2013-01-1476
 Published 04/08/2013
 Copyright © 2013 SAE International
 doi:10.4271/2013-01-1476
 saealtpow.saejournals.org

Development of a New Two-Motor Plug-In Hybrid System

Naritomo Higuchi, Yoshihiro Sunaga, Masashi Tanaka and Hiroo Shimada
 Honda R&D Co., Ltd.

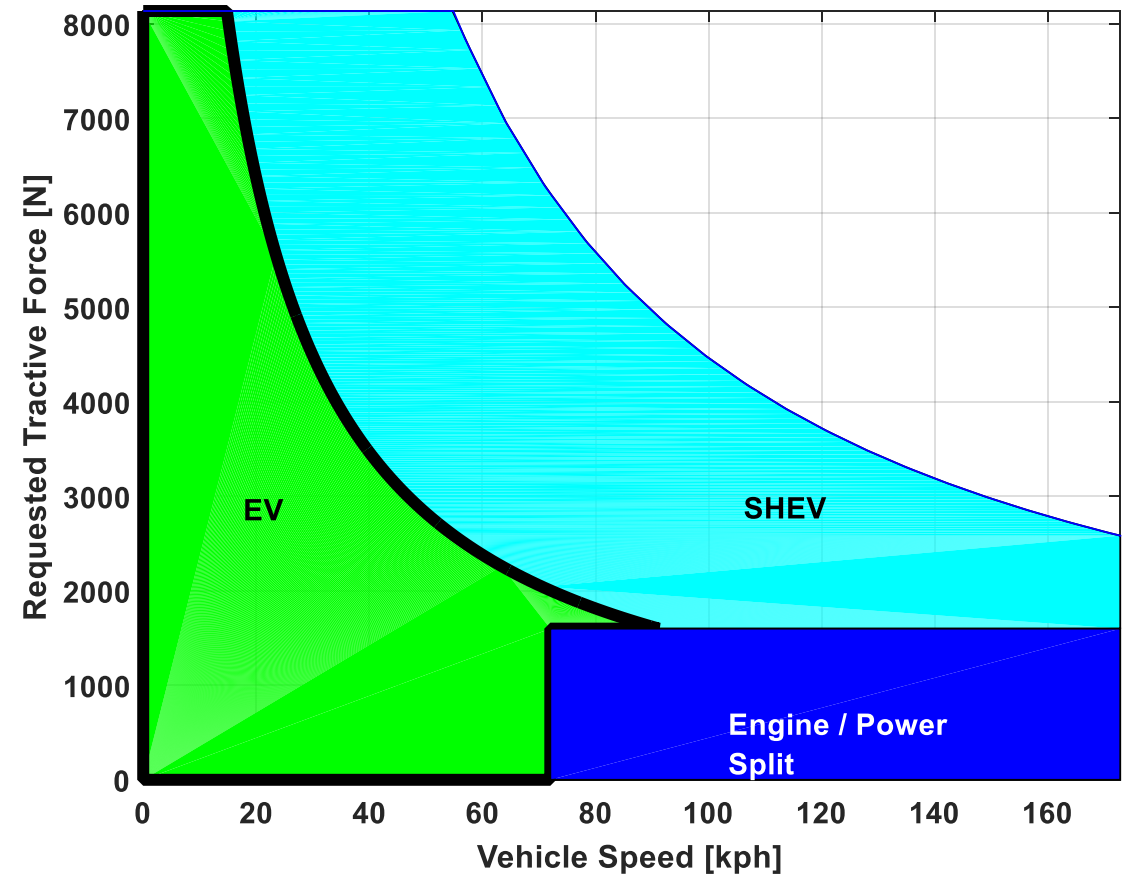
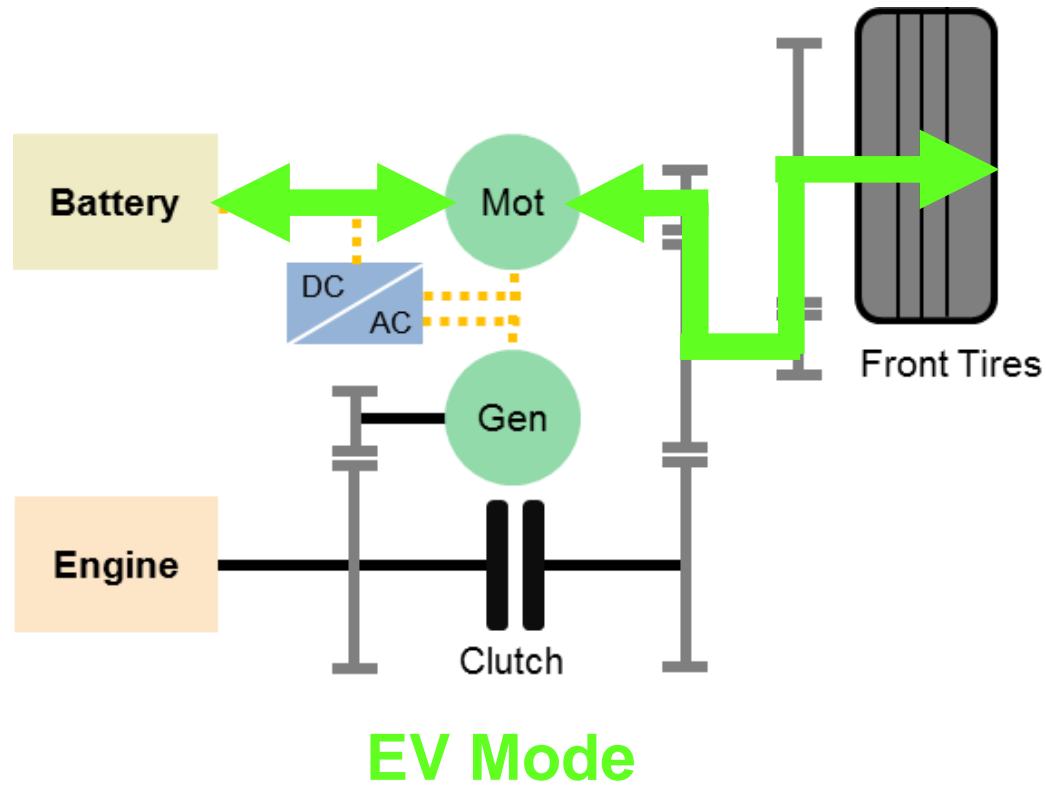

Multi-Mode HEV Review

SAE International

2013-01-1476
 Published 04/08/2013
 Copyright © 2013 SAE International
 doi:10.4271/2013-01-1476
 saealtpow.saejournals.org

Development of a New Two-Motor Plug-In Hybrid System

Naritomo Higuchi, Yoshihiro Sunaga, Masashi Tanaka and Hiroo Shimada
 Honda R&D Co., Ltd.

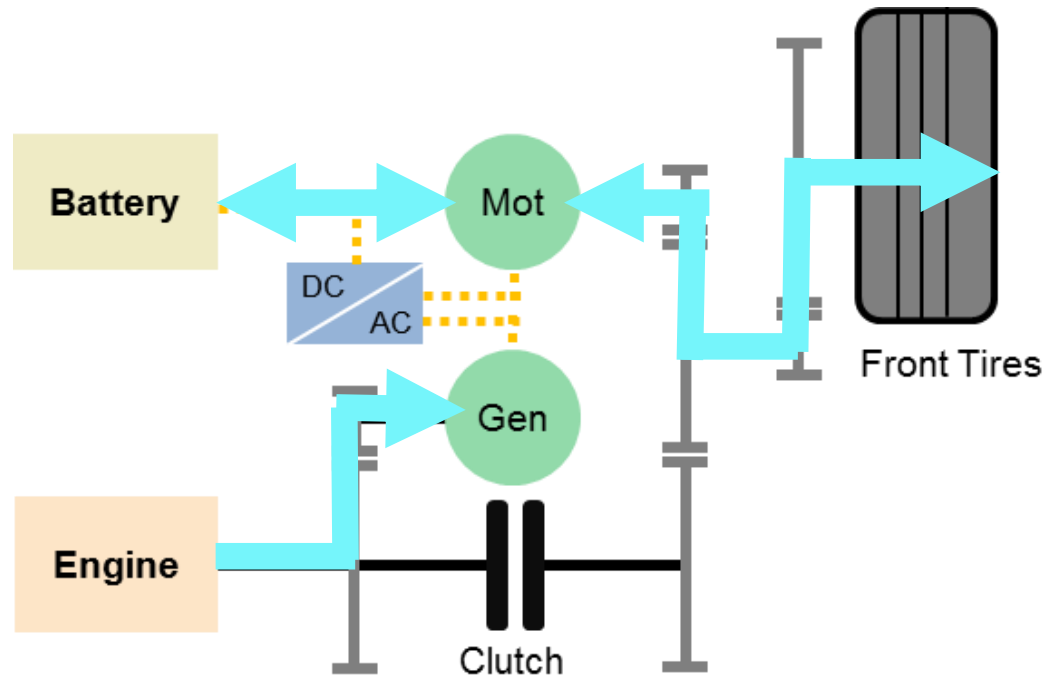

SHEV Mode

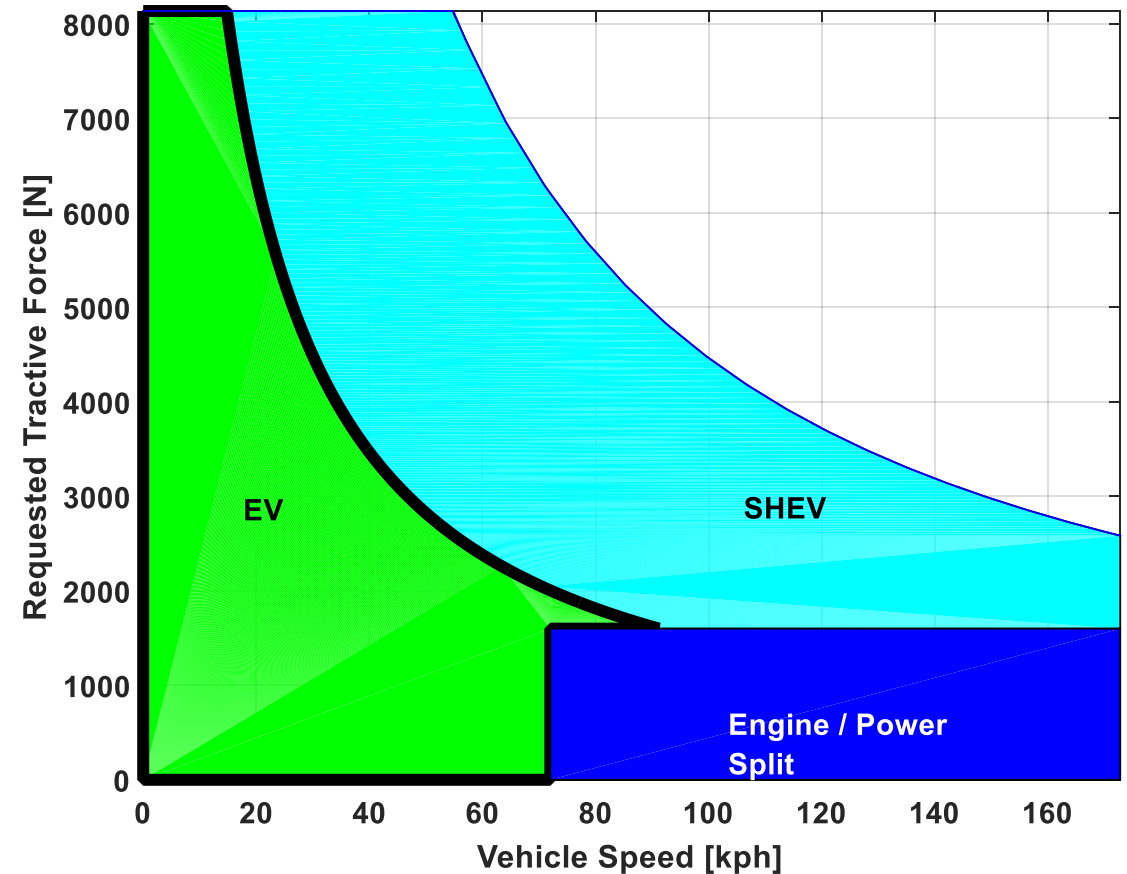

Multi-Mode HEV Review

SAE International

2013-01-1476
 Published 04/08/2013
 Copyright © 2013 SAE International
 doi:10.4271/2013-01-1476
 saealtpow.saejournals.org

Development of a New Two-Motor Plug-In Hybrid System

Naritomo Higuchi, Yoshihiro Sunaga, Masashi Tanaka and Hiroo Shimada
 Honda R&D Co., Ltd.

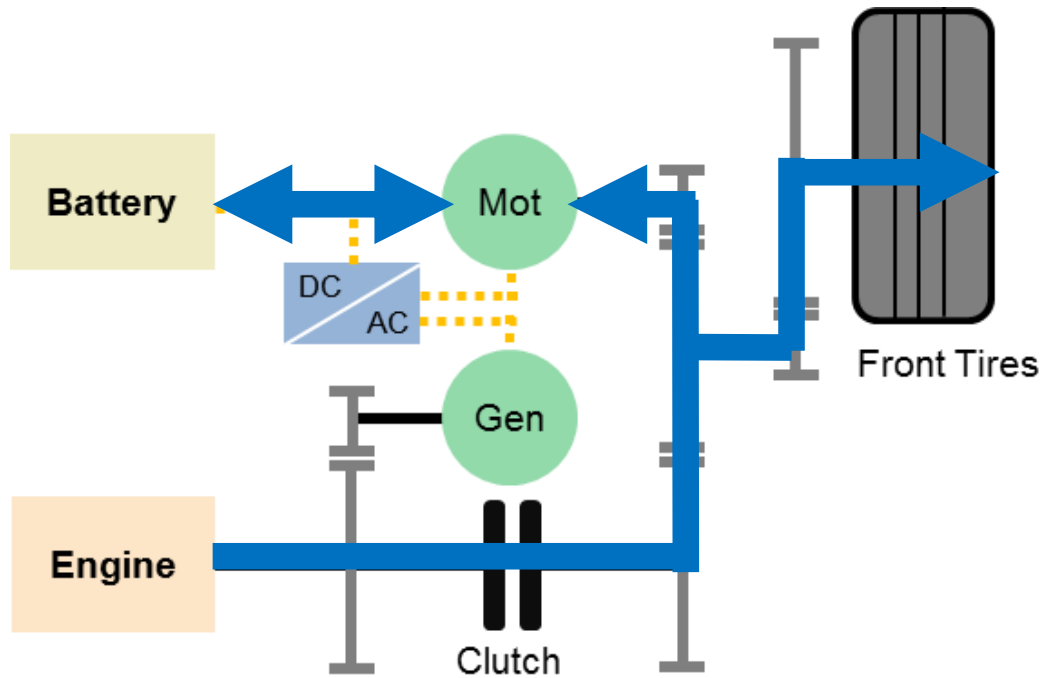

Engine Mode

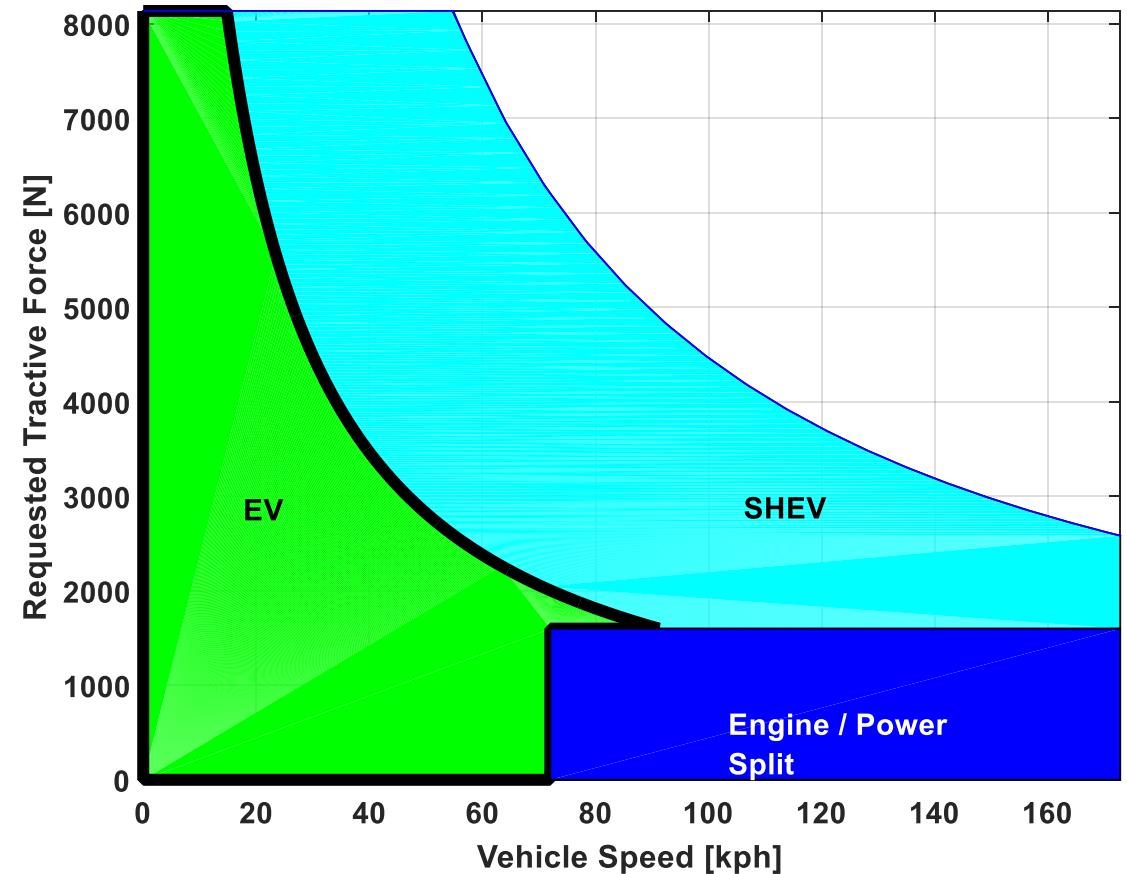

Design Optimization Problem Statement

- Maximize MPGe
 - FTP75 and HWFET
 - Weighted MPGe = $0.55(\text{FTP75}) + 0.45(\text{HWFET})$

- Optimize Parameters:
 - 5 control parameters
 - EV, SHEV, Engine mode boundaries
 - 1 hardware parameter
 - Final differential ratio

- Use PC
 - Simulink Design Optimization (SDO)
 - Parallel Computing Toolbox (PCT)

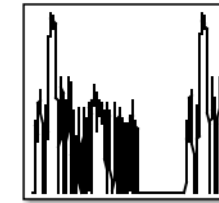

Drive Cycle Source1
FTP75 (2474 seconds)

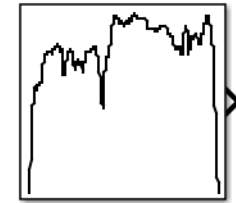

Drive Cycle Source
HWFET (765 seconds)

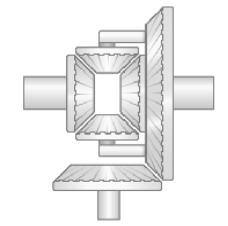
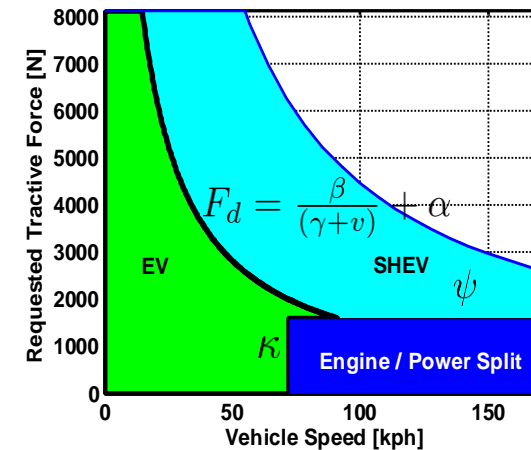

Differential Ratio



Lenovo ThinkPad T450s
Dual Core i7 2.60GHz
12 GB RAM

Simulink Design Optimization

Speed Up Best practices

- Accelerator mode
- Fast Restart

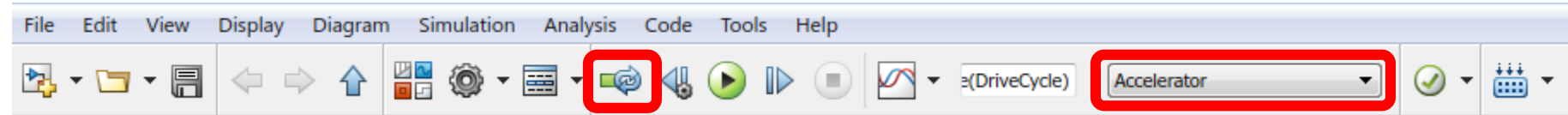

- Use Parallel Computing Toolbox

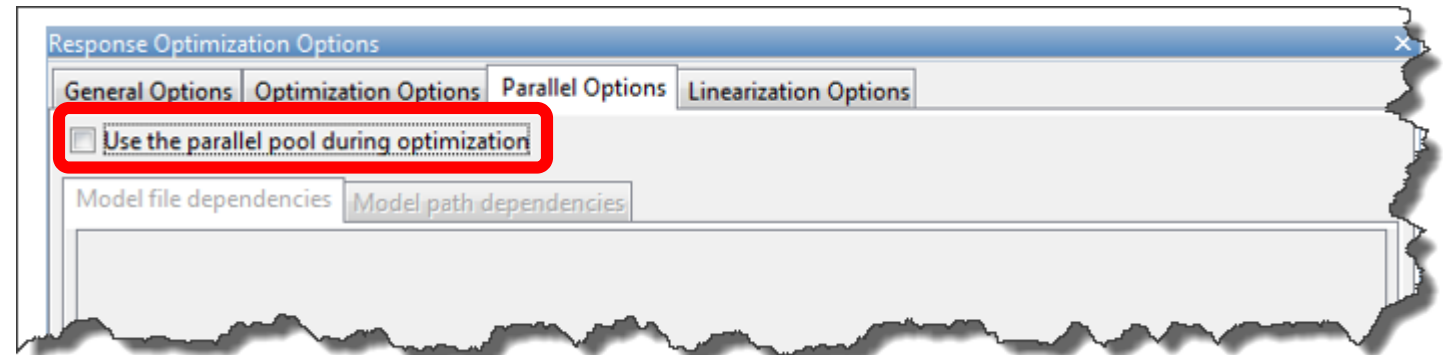

- Specify Simulation timeout

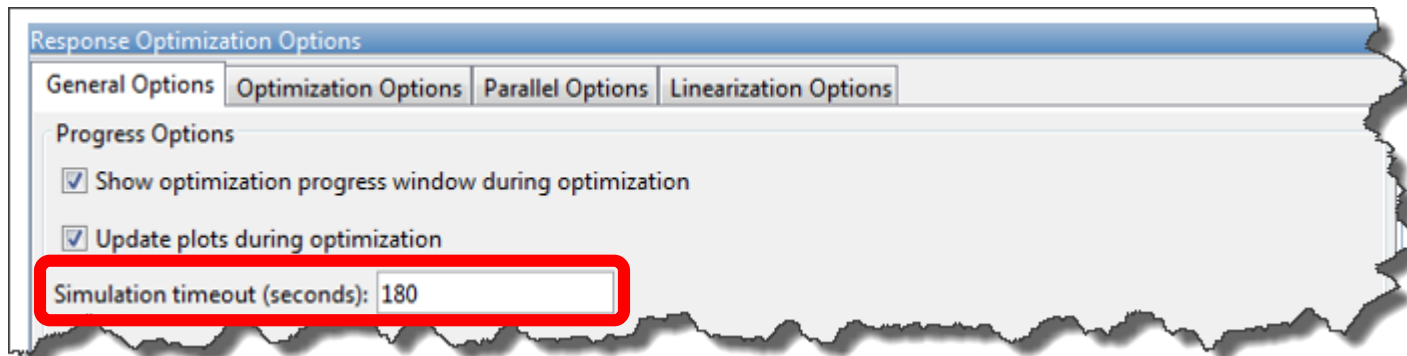

Optimization Results

Simulink Design Optimization → Response Optimization

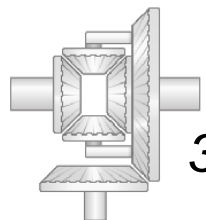
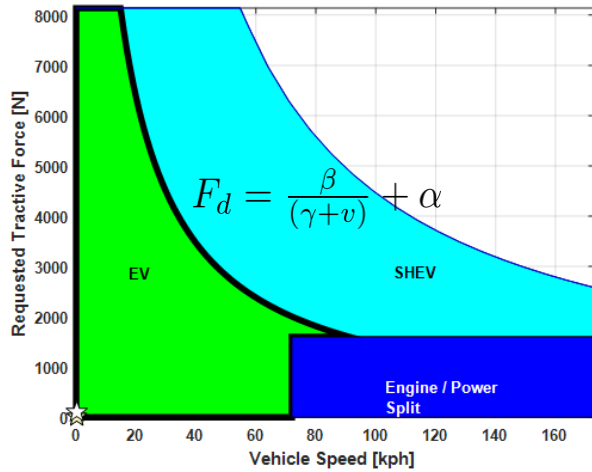

3.42:1

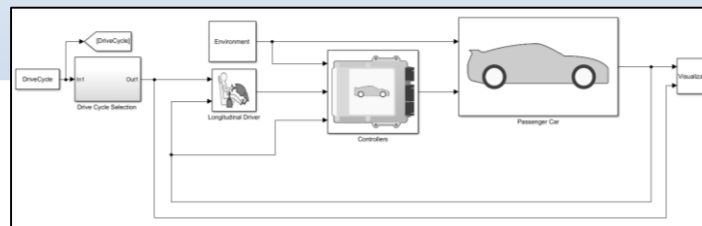
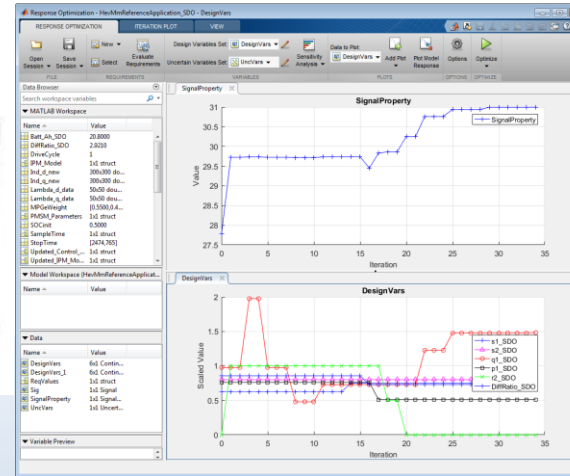

~ 12 Hours

+ 2% MPGe

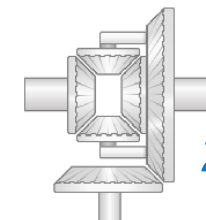
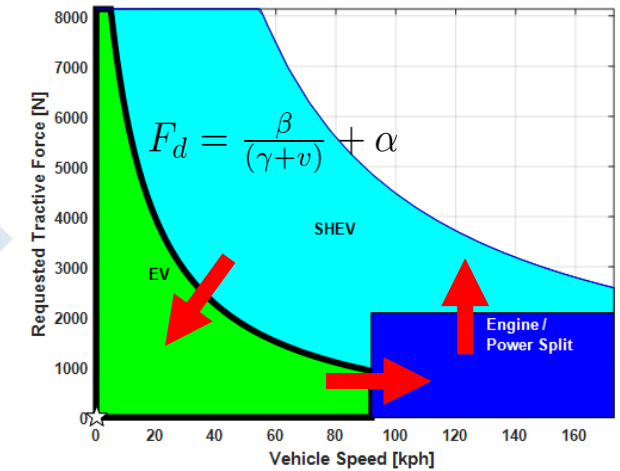

2.92:1

HEV Design Optimization Examples

- Example 1
 - Simultaneous control and hardware parameter optimization

- Example 2
 - Find single set of control parameters that work for different driving conditions

Powertrain Control – Charge Sustaining / PHEV Power-Split

SAE International

2011-01-2451
Published 06/01/2012
Copyright © 2012 SAE International
doi:10.4271/2011-01-2451
saealtpow.saejournals.org

Optimization of Electrified Powertrains for City Cars

Andreas Balazs
Aachen Univ.

Edoardo Morra
Politecnico di Torino

Stefan Pischinger
FEV GmbH

– SOC Optimal calculation

$$SOC_{opt}^* = \frac{E_{batt} SOC_{opt} \eta_{rech} M_{veh} v_{veh}^2}{E_{batt}}$$

(2)

– Engine Power Calculation

$$P_{ICE,dem} = P_{dem,trac} + k_2 (SOC_{opt}^* - SOC_{act})$$

(3)

– Minimum Eng On Power

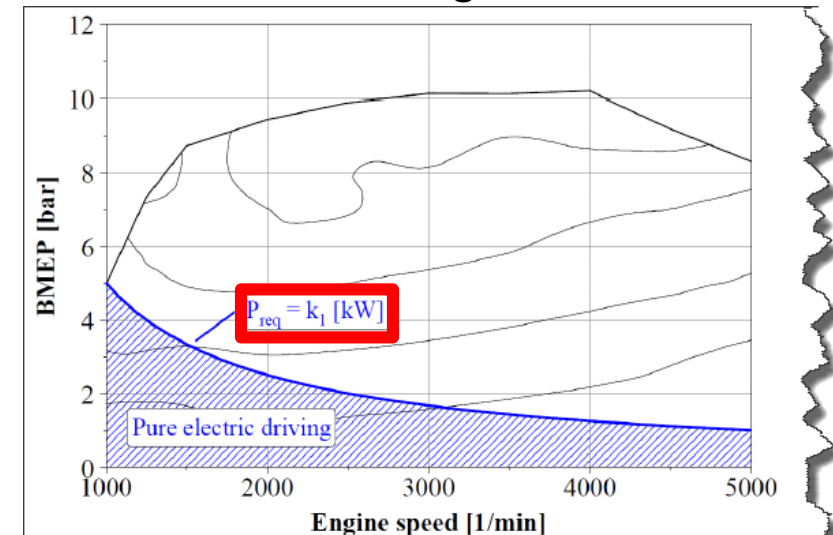
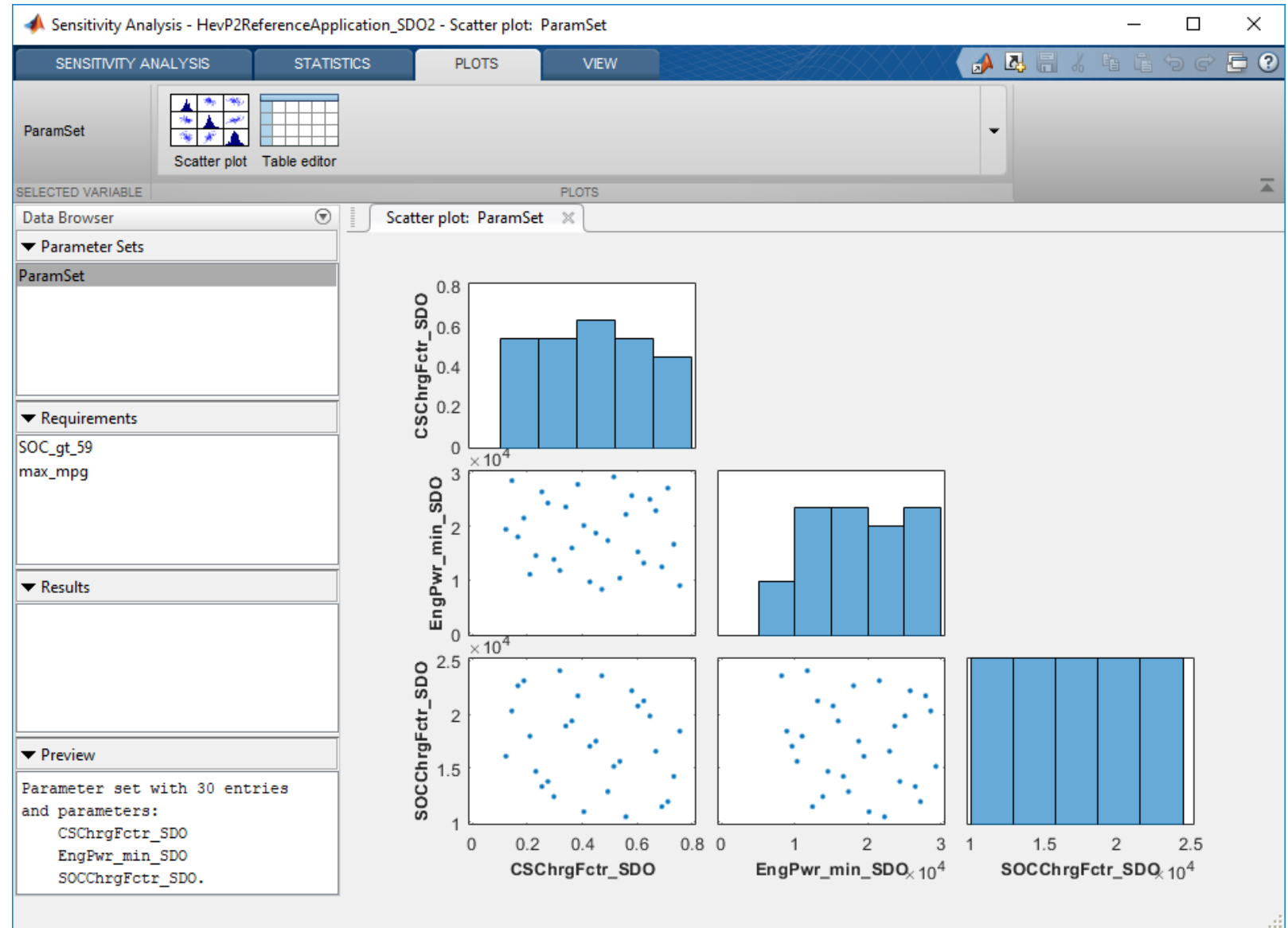

Figure 5. Hybrid operating strategy: parameter k_1

Sensitivity Analysis

- Determine sensitivity of fuel economy and ability to charge sustain to changes in design parameters
- Simulink Design Optimization UI
 - Create sample sets
 - Define constraints
 - Run Monte Carlo simulations
 - Speed up using parallel computing



Sensitivity Analysis – Results

■ HWFET

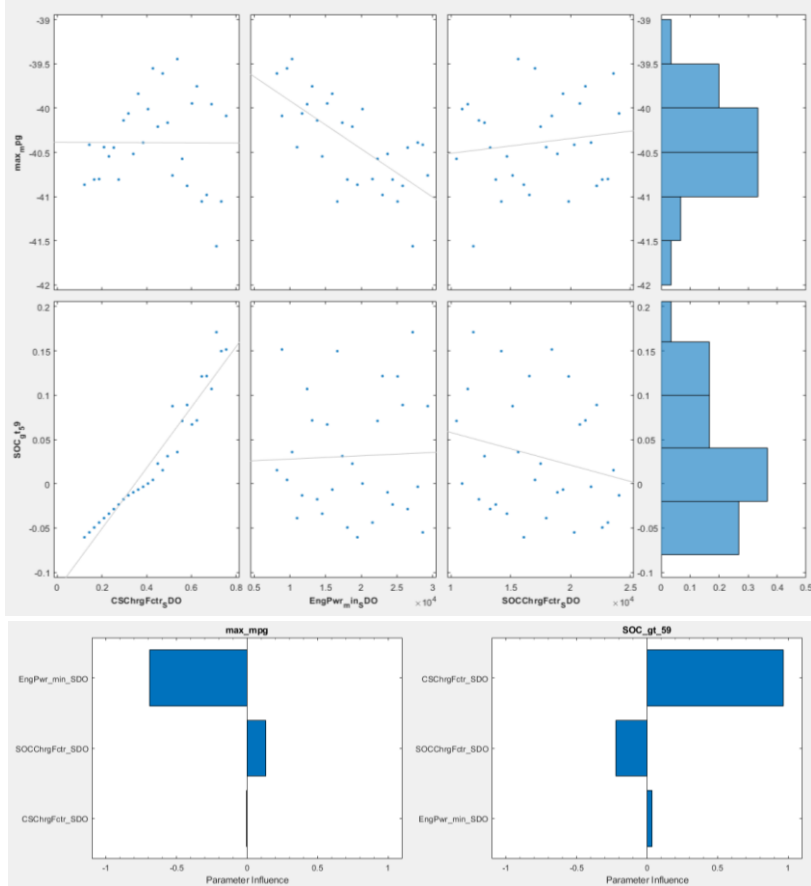

- CS Factor highest correlation for charge sustaining
- Min Engine Power highest correlation for max mpg

■ US06

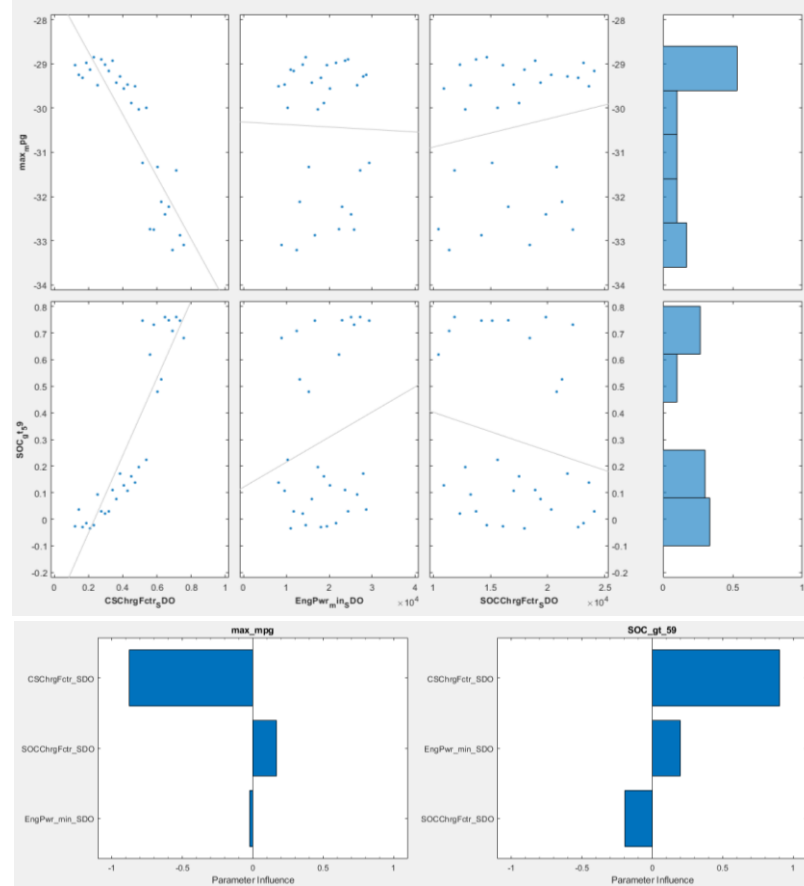

- CS Factor highest correlation for charge sustaining and max mpg

■ FTP72

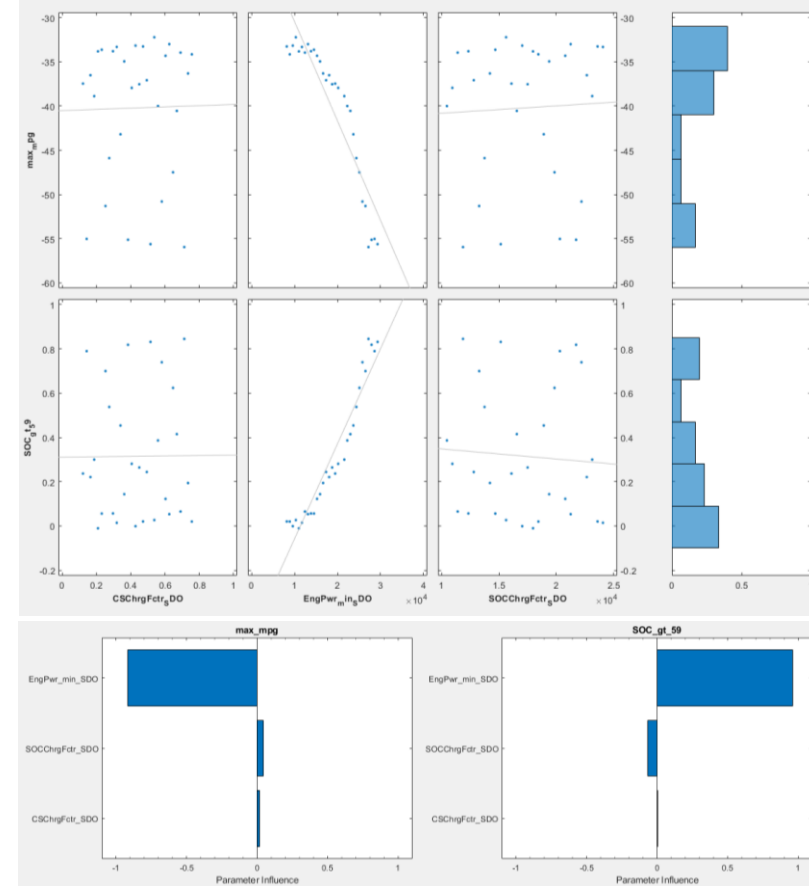

- Min Engine Power highest correlation for maximizing mpg and charge sustaining

Optimization Process – Sensitivity Analysis

- Sensitivity Analysis
 - Best numbers in experiment that maximized mpg with minimum delta SOC

	Charge Sustaining Factor	minimum Engine Power	SOC Factor	mpg	delta SOC (%)
HWFET	0.1219	19453	16094	40.87	2.56
US06	0.1656	18047	22656	29.31	0.76
FTP72	0.2094	11016	17969	33.82	-0.39

- Note the variation in the 3 design variables
- Next step:
 - use Response Optimization to attempt to find a *unified* set of parameters to maximize mpg and minimize delta SOC over all 3 drive cycles

Response Optimization

- Find optimal design parameters that satisfy multiple objectives and constraints simultaneously
- Simulink Design Optimization UI
 - Define design variables, objective functions, and constraints
 - Use 'Uncertain Variable' (Drive Cycle) to run all 3 cycles in 1 iteration
 - Speed up using parallel computing

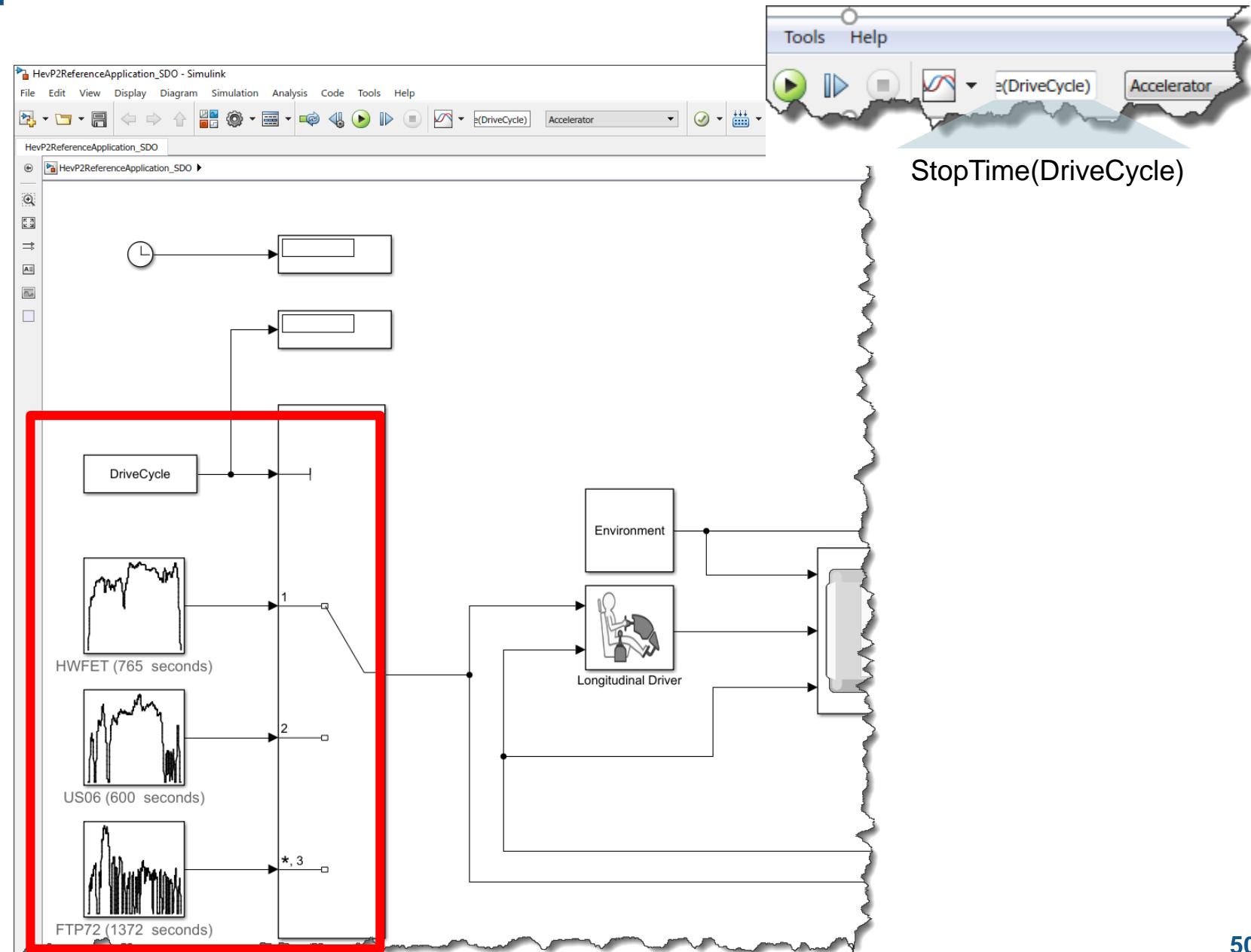

Response Optimization – Results

1. View Results

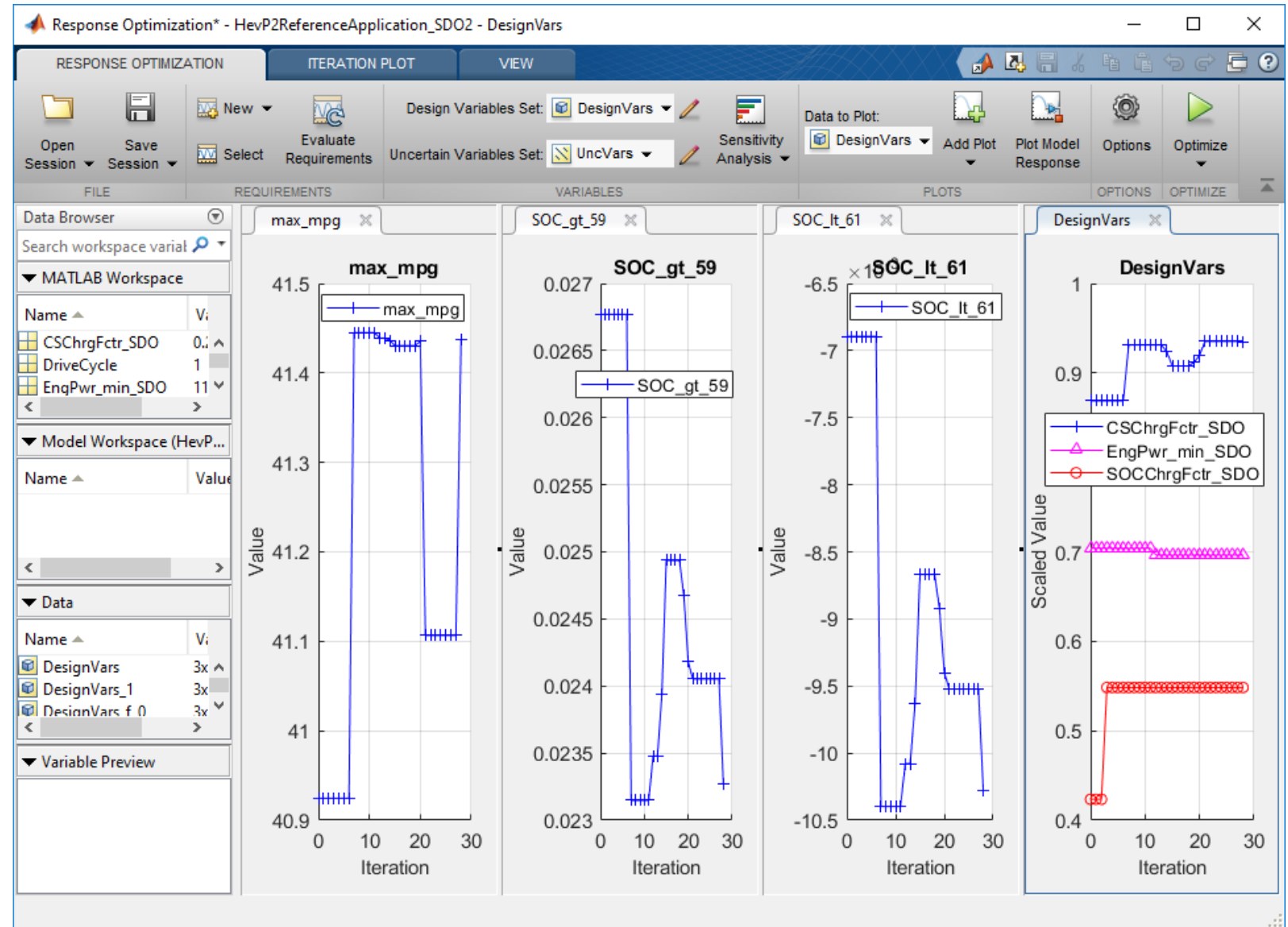
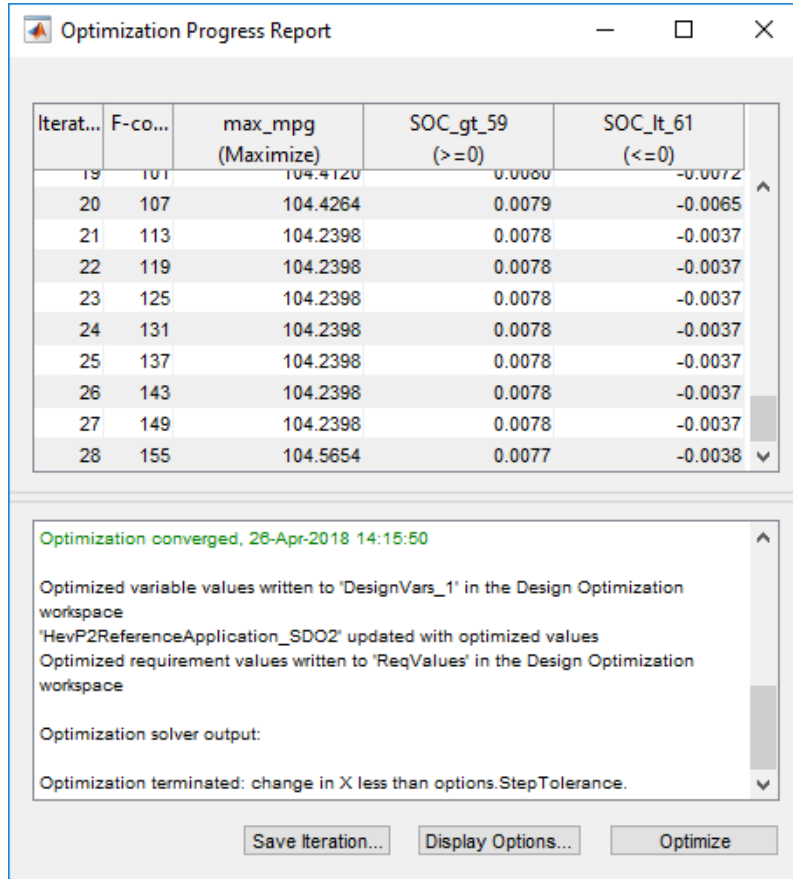

SDO – Response Optimization

- Summary

Sensitivity Analysis					
	Charge Sustaining Factor	minimum Engine Power	SOC Factor	mpg	delta SOC (%)
HWFET	0.1219	19453	16094	40.87	2.56
US06	0.1656	18047	22656	29.31	0.76
FTP72	0.2094	11016	17969	33.82	-0.39

3 Cycle Response Optimization					
	Charge Sustaining Factor	minimum Engine Power	SOC Factor	mpg	delta SOC (%)
HWFET	0.2337	11408	17969	41.44	0.37
US06				29.14	0.78
FTP72				34	-0.55

- Found single set of design variables to maximize mpg and charge sustain!***

Key Points

- Efficient plant modeling enables Model-Based Design (MBD)
- Powertrain Blockset provides HEV modeling framework, components, and controls
- **Design / optimize** plant and controls **together** as a system

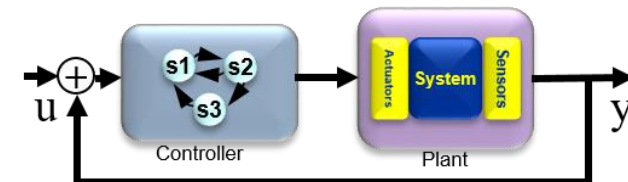
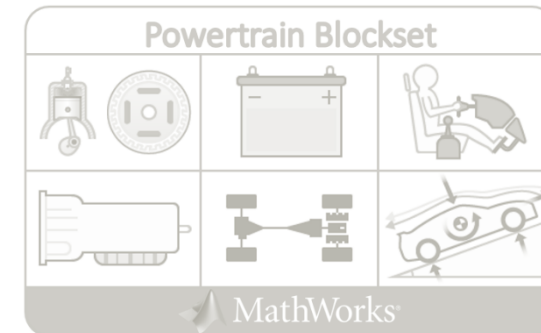
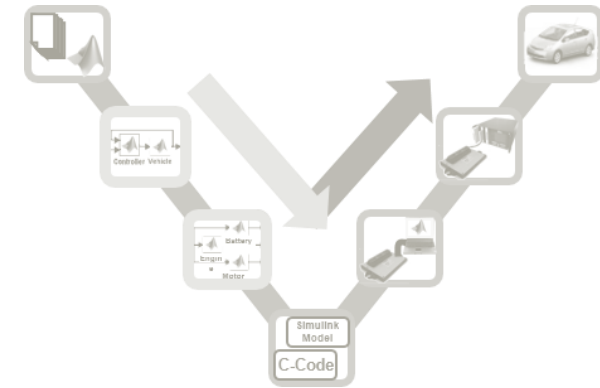

Key Points

- Efficient **plant** modeling enables **Model-Based Design (MBD)**
- **Powertrain Blockset** provides HEV modeling **framework**, components, and **controls**
- **Design / optimize** plant and controls **together** as a system

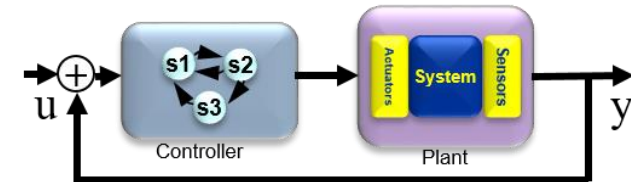
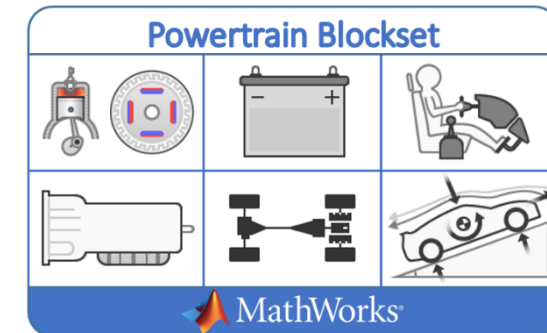
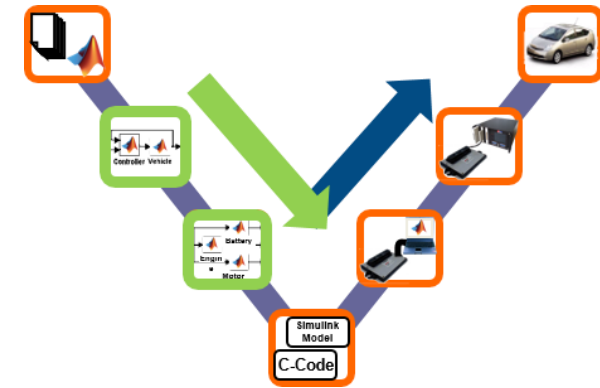

Thank You