

MATLAB EXPO 2019

Seamless System Design of RF Transceivers and Antennas for Wireless Systems

Vidya Viswanathan

Application Engineer – Signal Processing & Communication

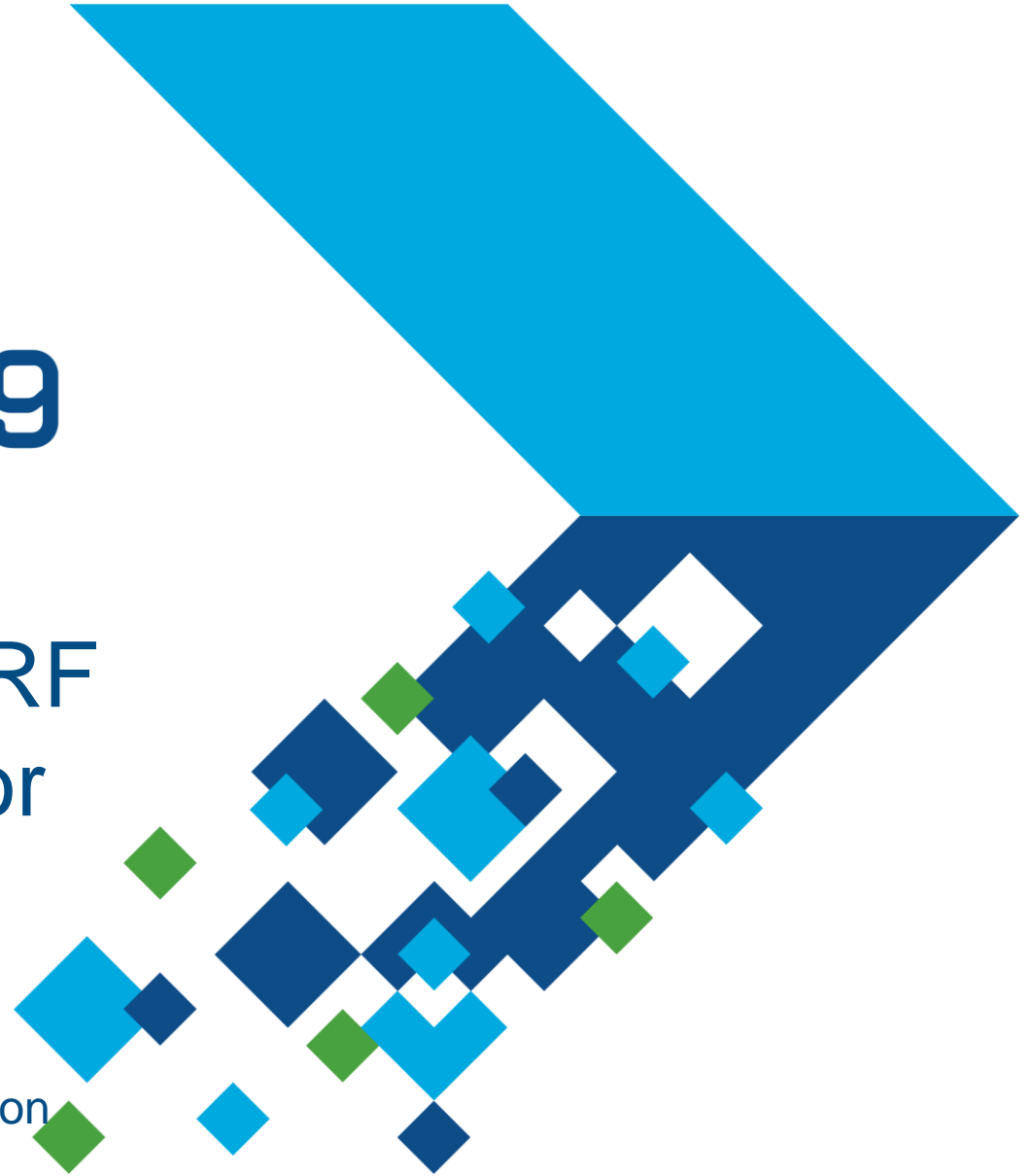

Multi-Domain Engineering for Advanced Wireless Systems

Subsystems must be designed and tested together

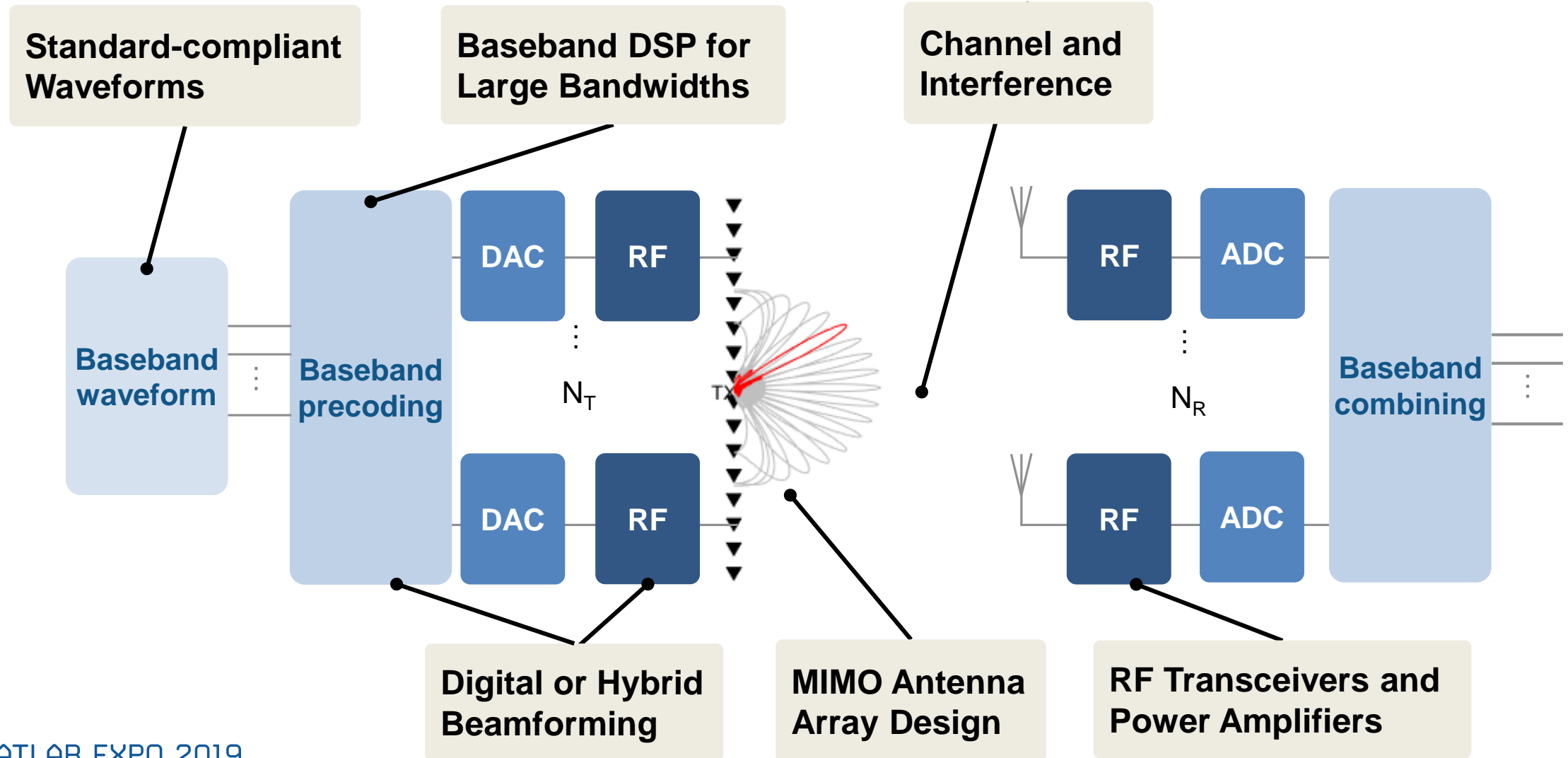

Agenda

RF Propagation & Network Coverage

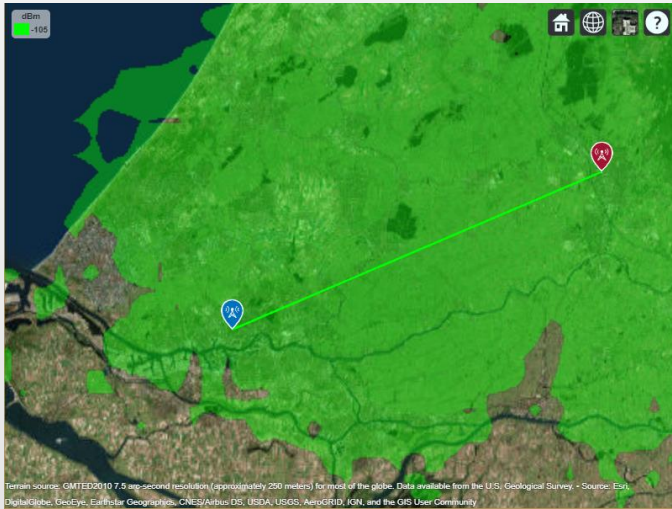

Beamforming for Multi-User Operation

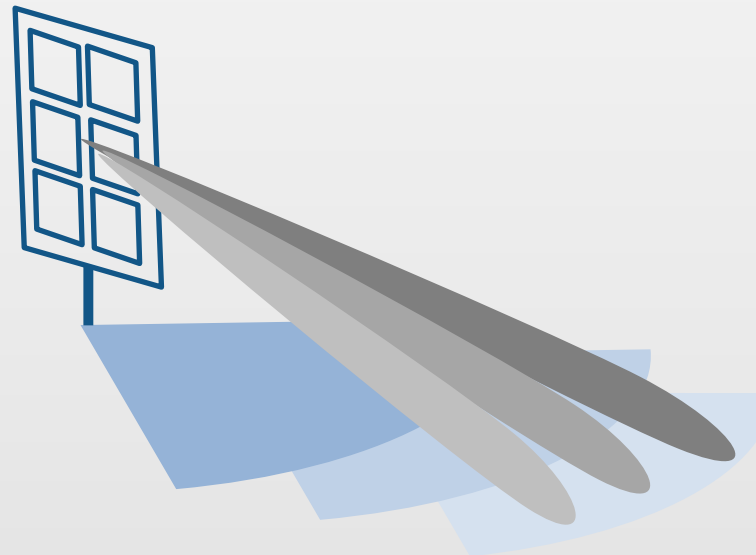

Power Amplifier & Digital Pre-distortion

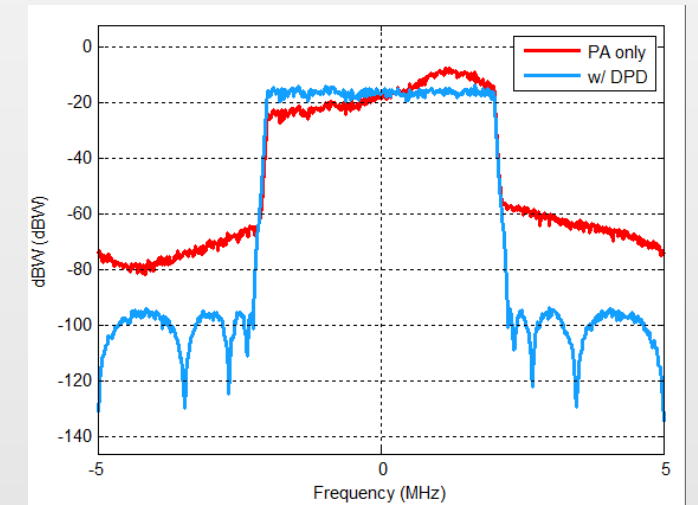

Antenna Design – Where To Start?

Antenna Designer App

- Select an antenna based on the desired specifications
- Design the antenna at the operating frequency
- Visualize results and iterate on antenna geometrical properties
- Generates MATLAB scripts for automation

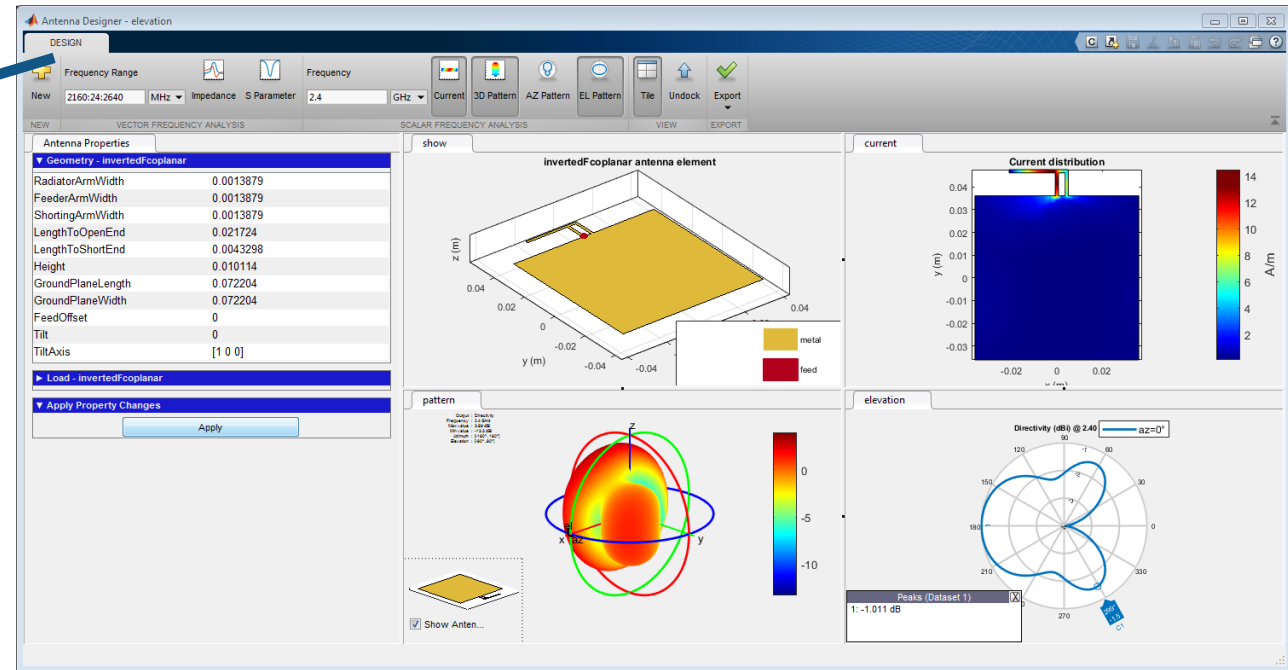

Building your First Antenna and Antenna Array

```
p = patchMicrostrip
p.Height = 0.01;
impedance(p, (500e6:10e6:2e9));
current(p, 1.7e9);
pattern(p, 1.7e9);
```

```
a = linearArray
a.Element = p;
a.ElementSpacing = 0.1;
a.NumElements = 4;
show(a);
patternElevation(a, 1.7e9, 0);
```

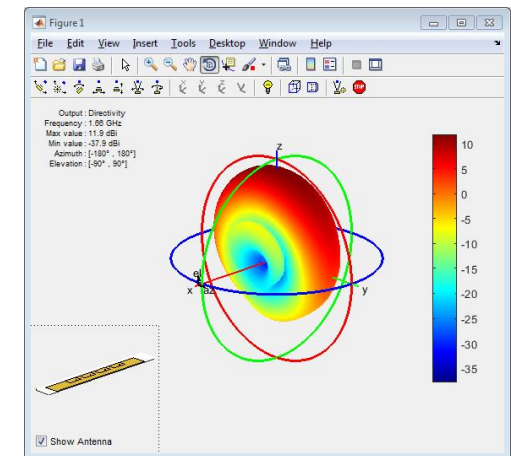
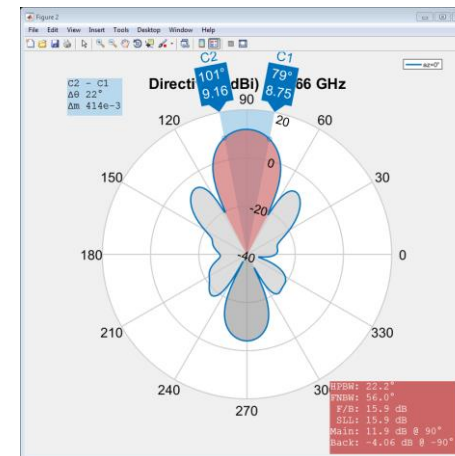
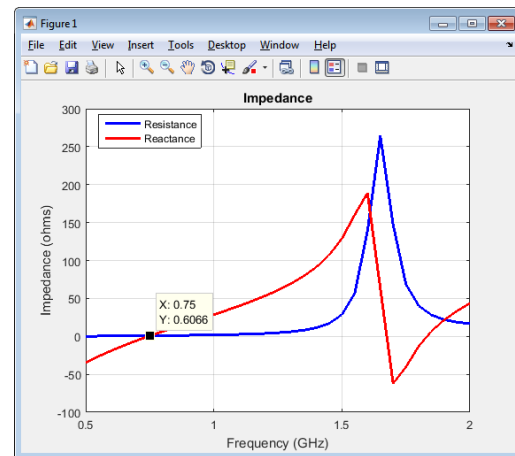
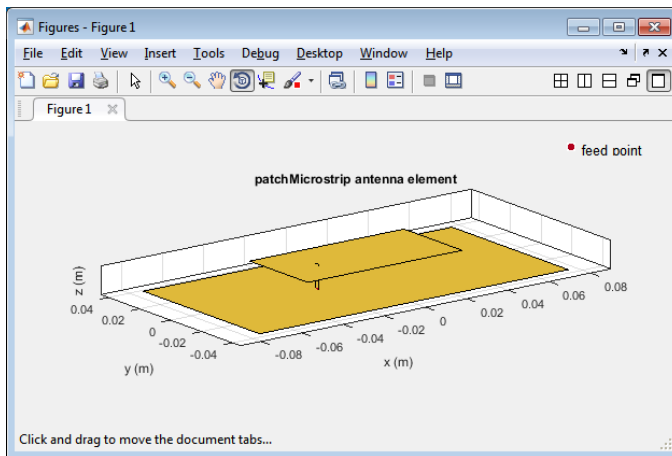

Printed Antenna Designing and Fabrication

Suitable for low cost applications requiring high antenna integration

- Design printed antennas with **pcbStack**
- Arbitrary dielectric and metal layers
- Define vias and feed structures
- Generate Gerber files

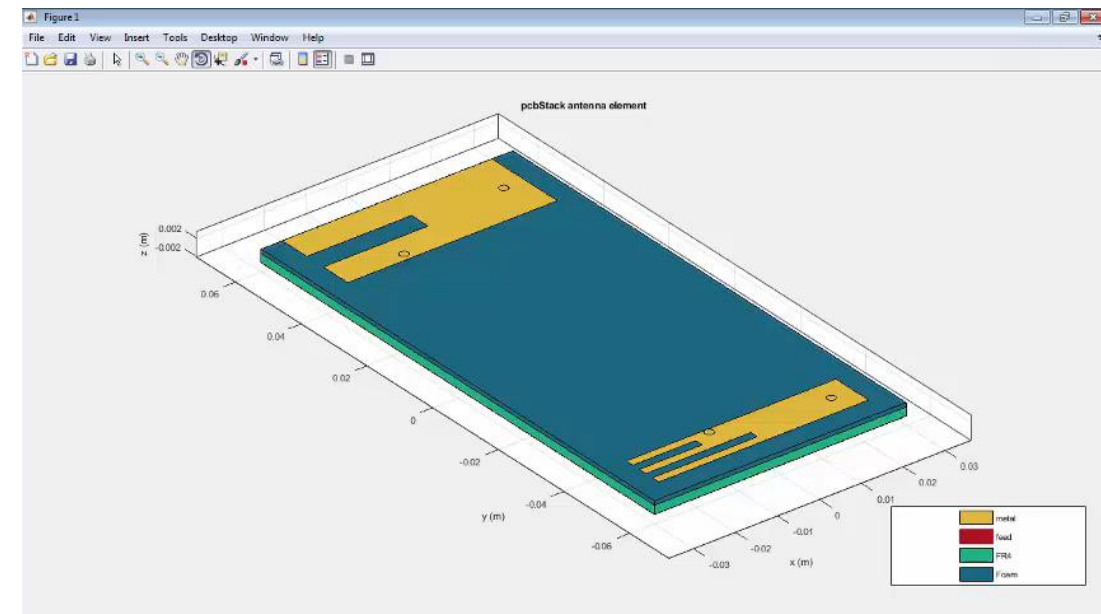
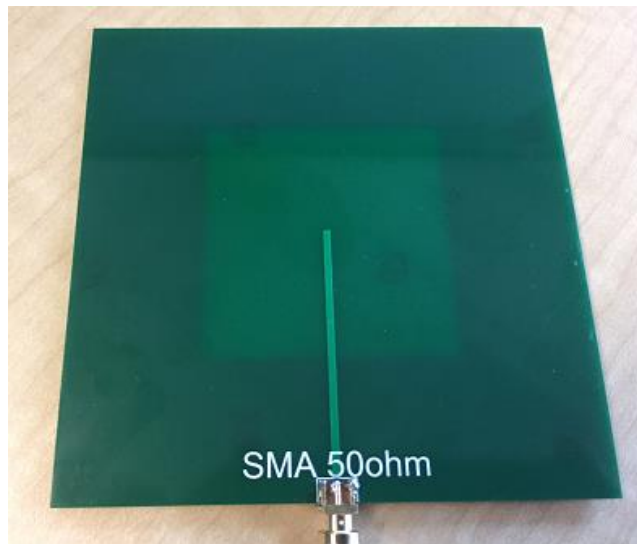

Antenna Design and Analysis

VHF YagiUda antenna designed with Antenna Toolbox to operate at 144.5MHz

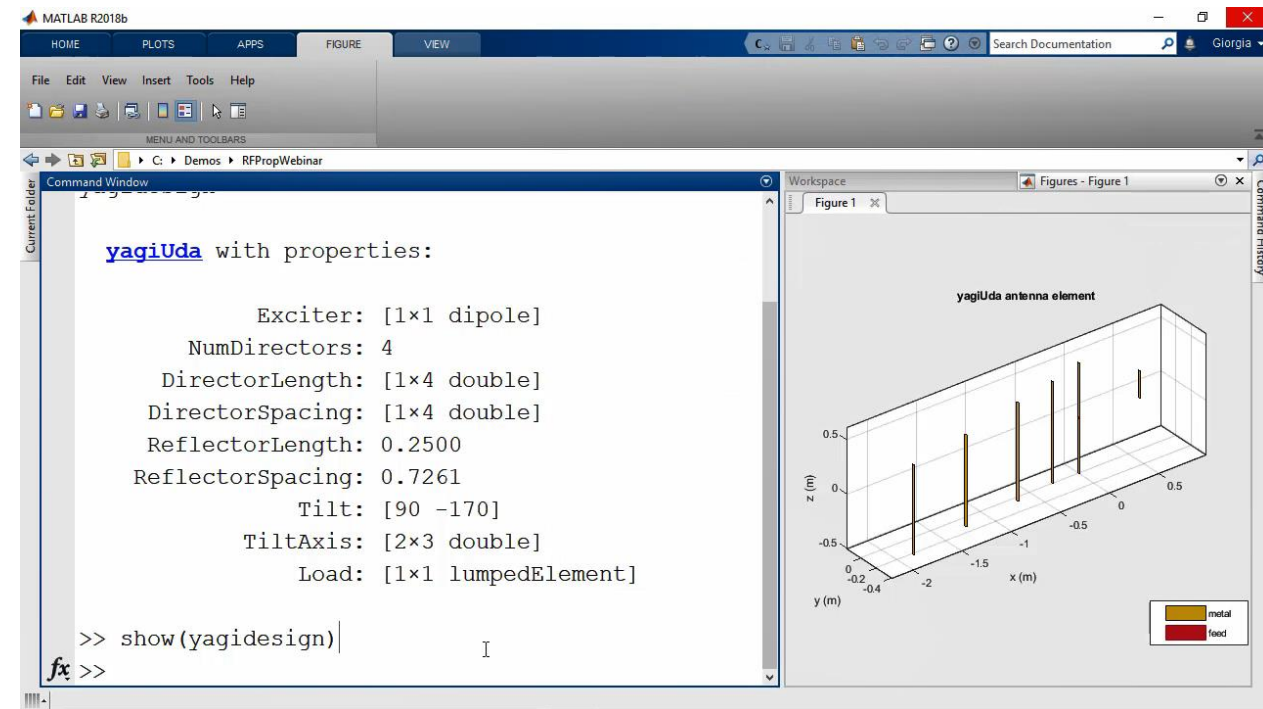
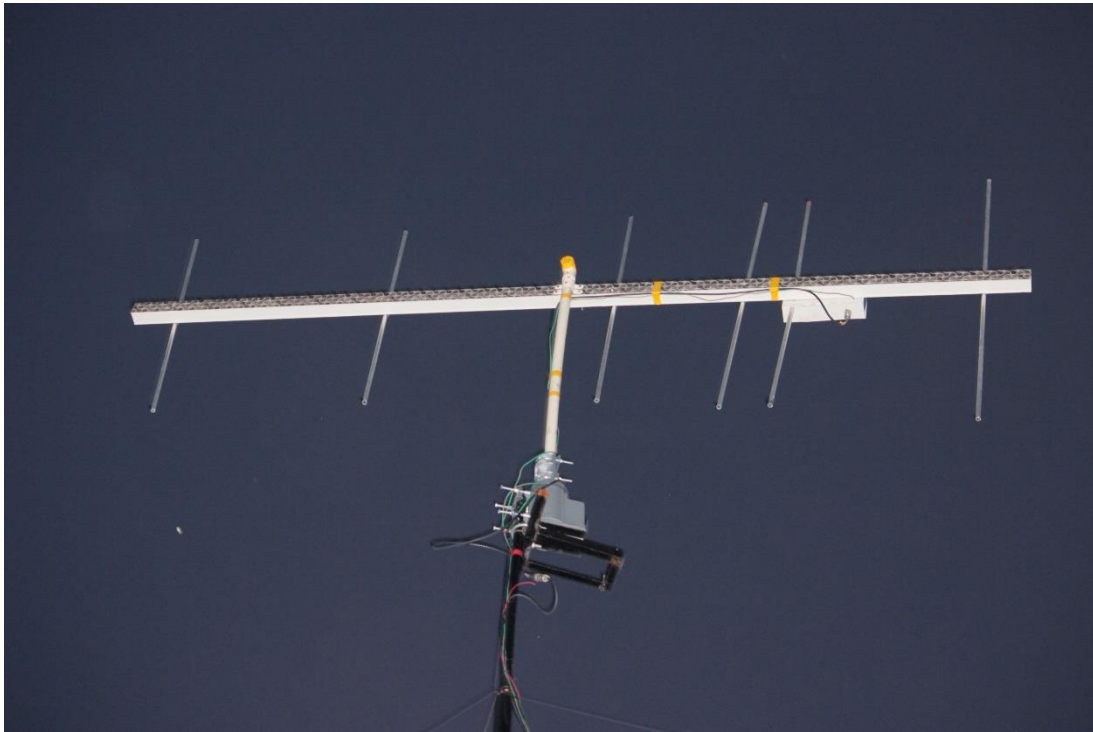

Antenna Placement and Coverage Analysis

- Position the antenna at a specific geographical location
- Show coverage of the antenna using Ideal free-space propagation model

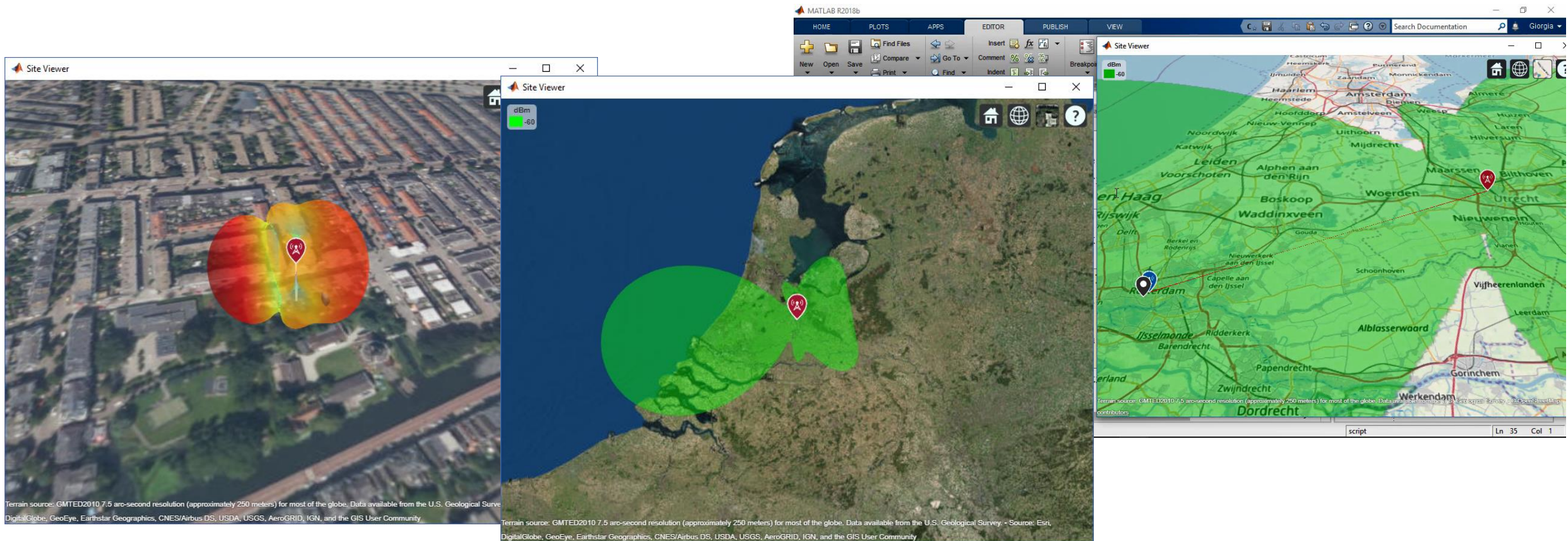

Visualize the Antenna on the Terrain

- Terrain Based Propagation Model: Longley-Rice
 - Statistical model taking into account diffraction and scattering
 - Operates between 20MHz and 20GHz
- Include atmospheric effects like rain, fog and gas

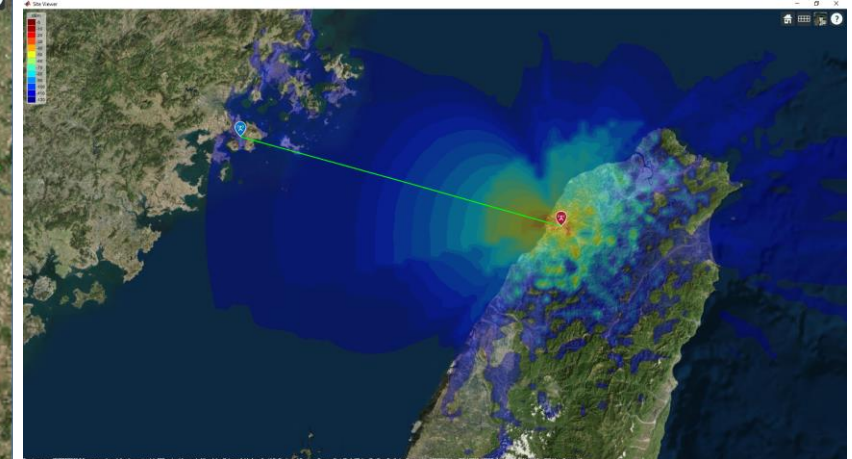
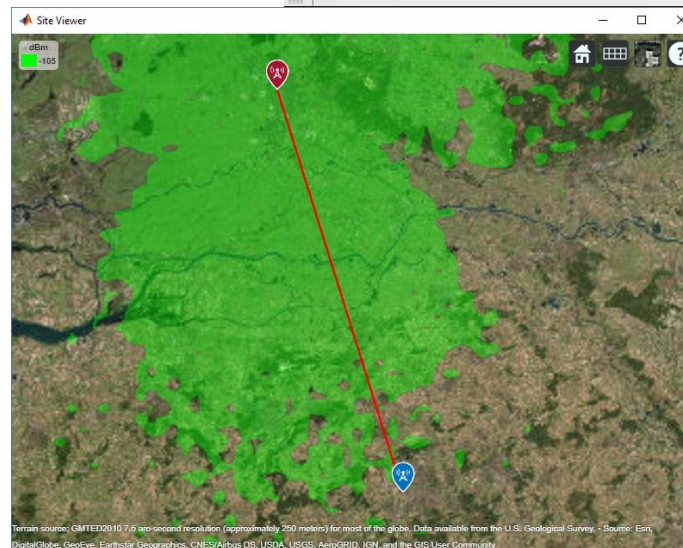
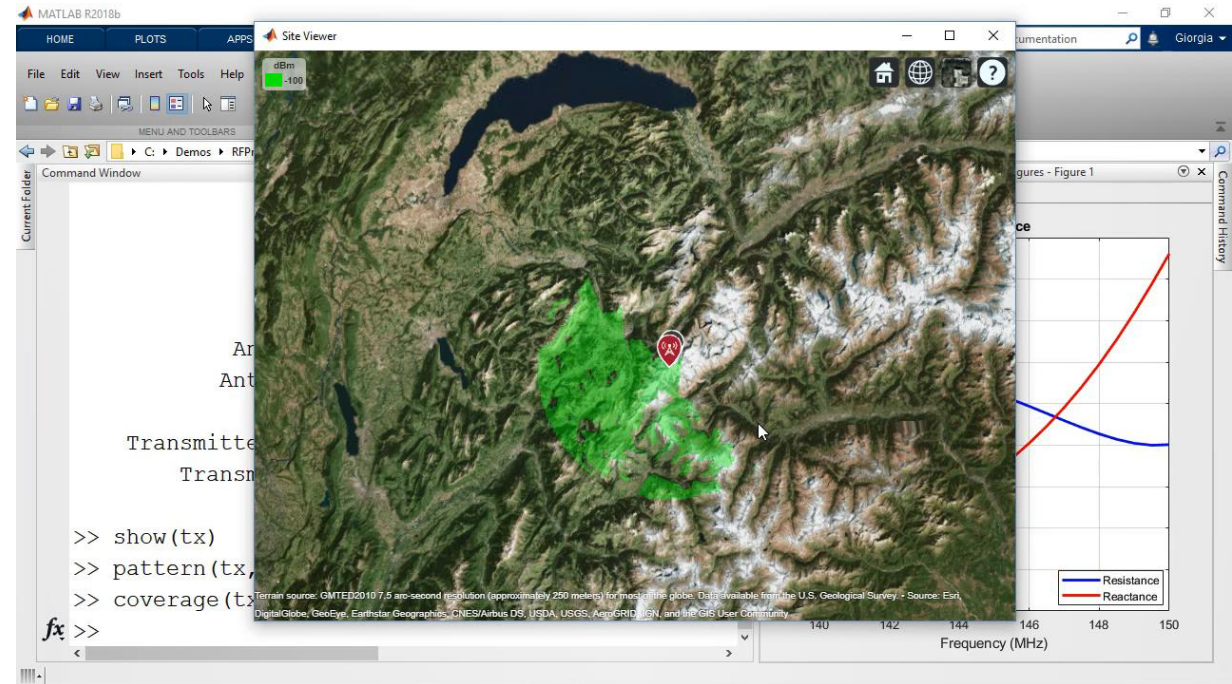

What did we see in this example?

- Antenna elements and arrays described by electromagnetic based solutions
- Terrain based coverage modeling with realistic antenna models
- Method can be extended to include RF propagation along with channel models

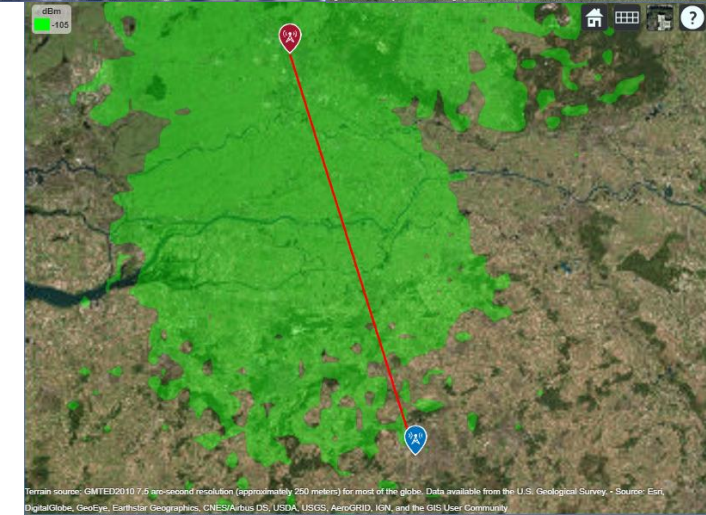
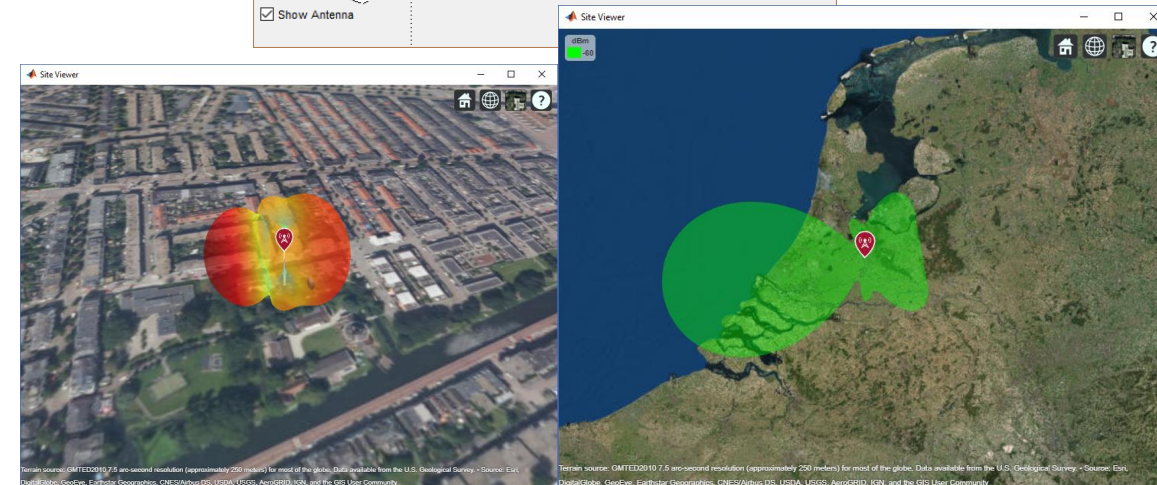
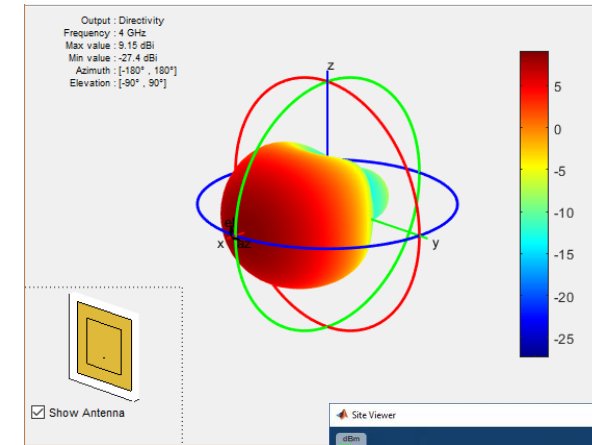

What's New?

Propagation Models

- TIREM
 - Statistical model taking into account reflection, diffraction, and absorption
 - Operates between 1MHz and 40GHz
- Include atmospheric effects like rain, fog and gas

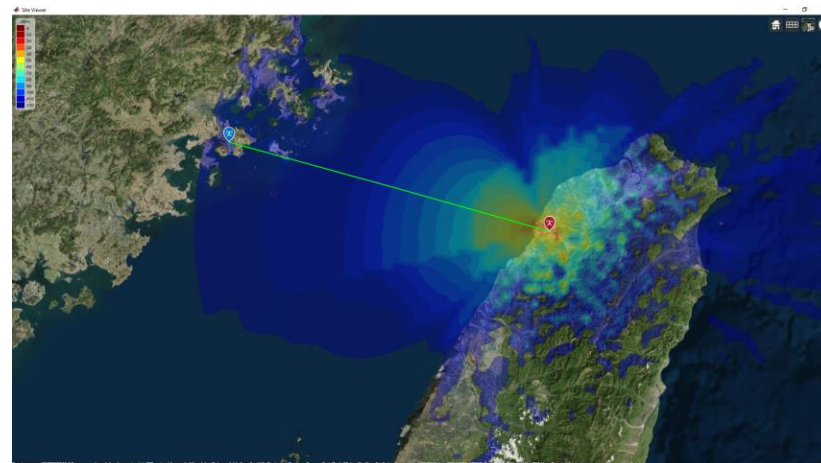
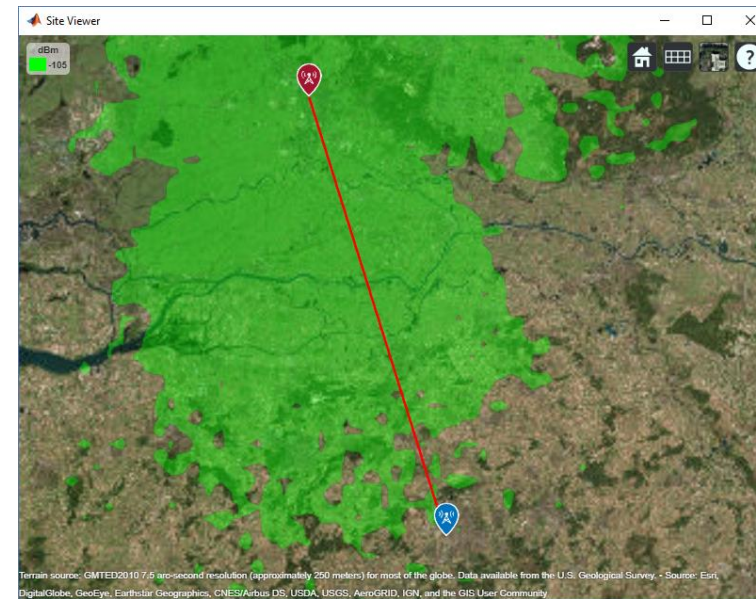

What's New?

Platform-Installed Antennas and Large Structures

- Import CAD files (STL) to describe large structures such as planes, ships, or cars
- Install antennas and arrays on a platform
- Analyze the effect of the large structure on the antenna performance
- Use physical optics in conjunction with the method of moments

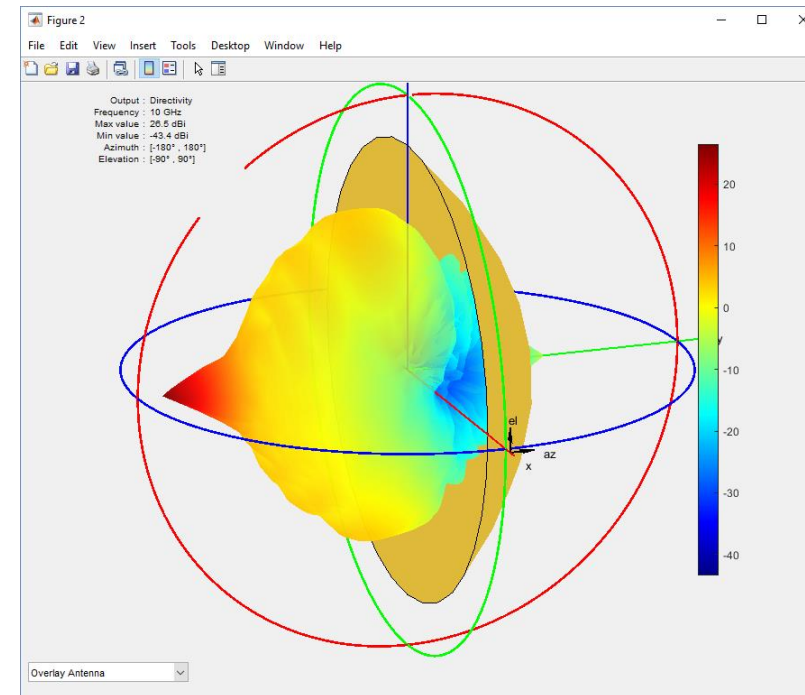

Agenda

RF Propagation & Network Coverage

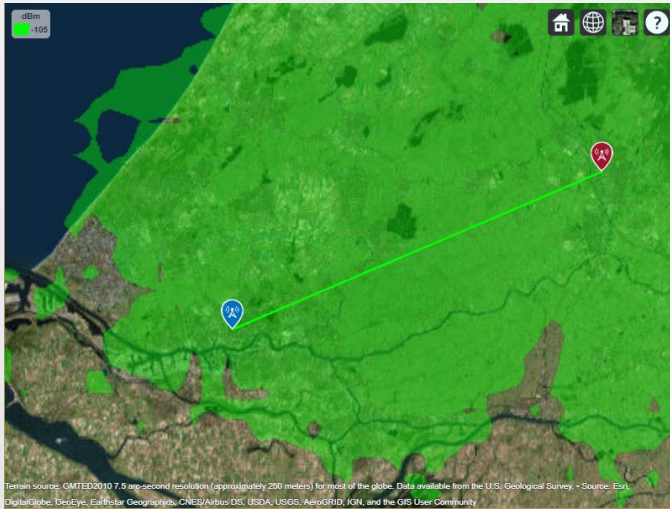

Beamforming for Multi-User Operation

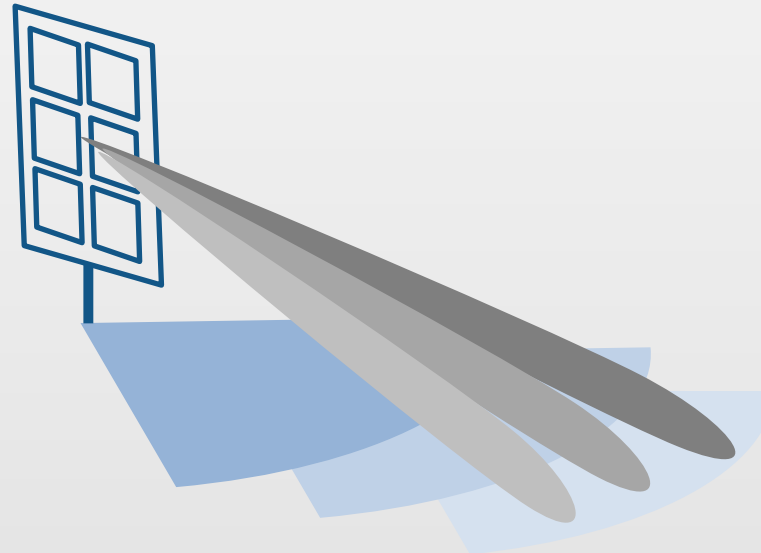

Power Amplifier & Digital Pre-distortion

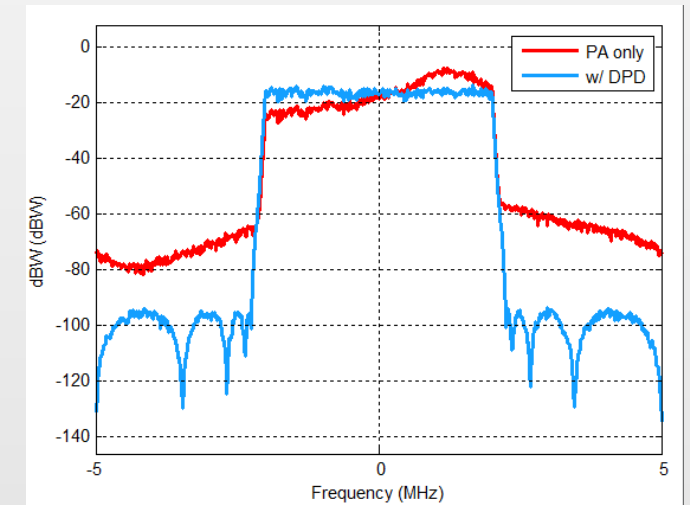

Array Beam Steering and Map Visualization

- 7x7 rectangular array of dipoles reflector-backed, operating at 10GHz
- Steer the array beam and assess coverage and links

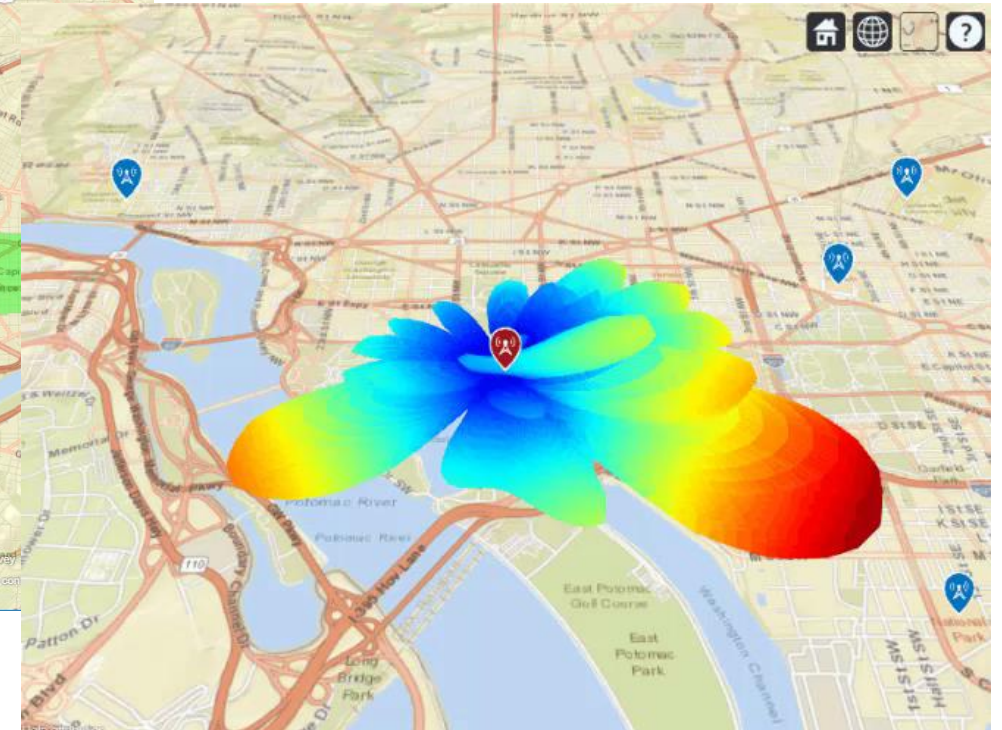
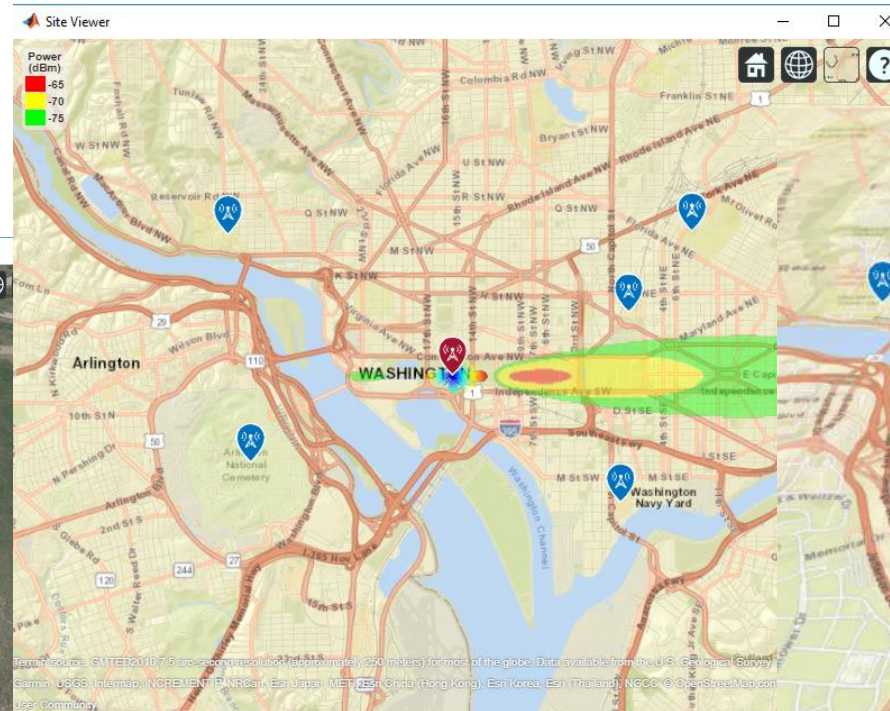

Beamforming for multi-user operation

- Coarse analog RF beamforming is the same for entire bandwidth
 - Subarray modules (panels) allow coarse elevation angle adjustment (by phase shifters)
 - MU groups are arranged by distance (ring structure)
- Fine beamforming in baseband is performed for OFDM mode in frequency domain
 - Fine horizontal separation of the users is done with baseband processing

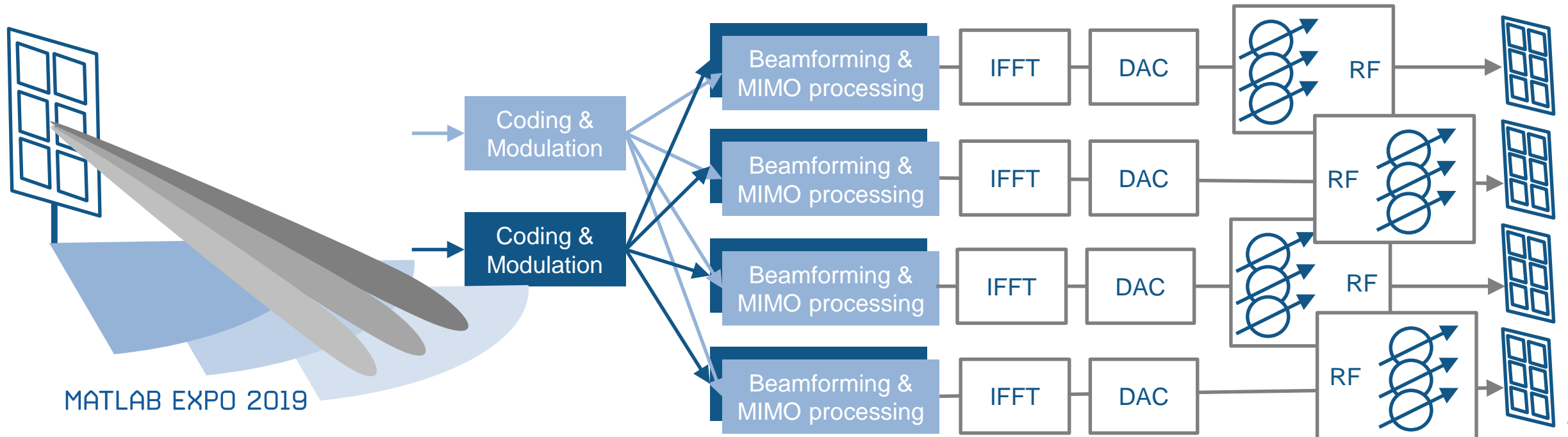

RF Front End Modelling using Circuit Envelope

- Direct conversion to IF (5GHz) and superhet up-conversion to mmWave (66GHz)
- Non-linearity (e.g. IP2, IP3, P1dB)
- Power dividers (e.g. S-parameters)
- Variable phase-shifters

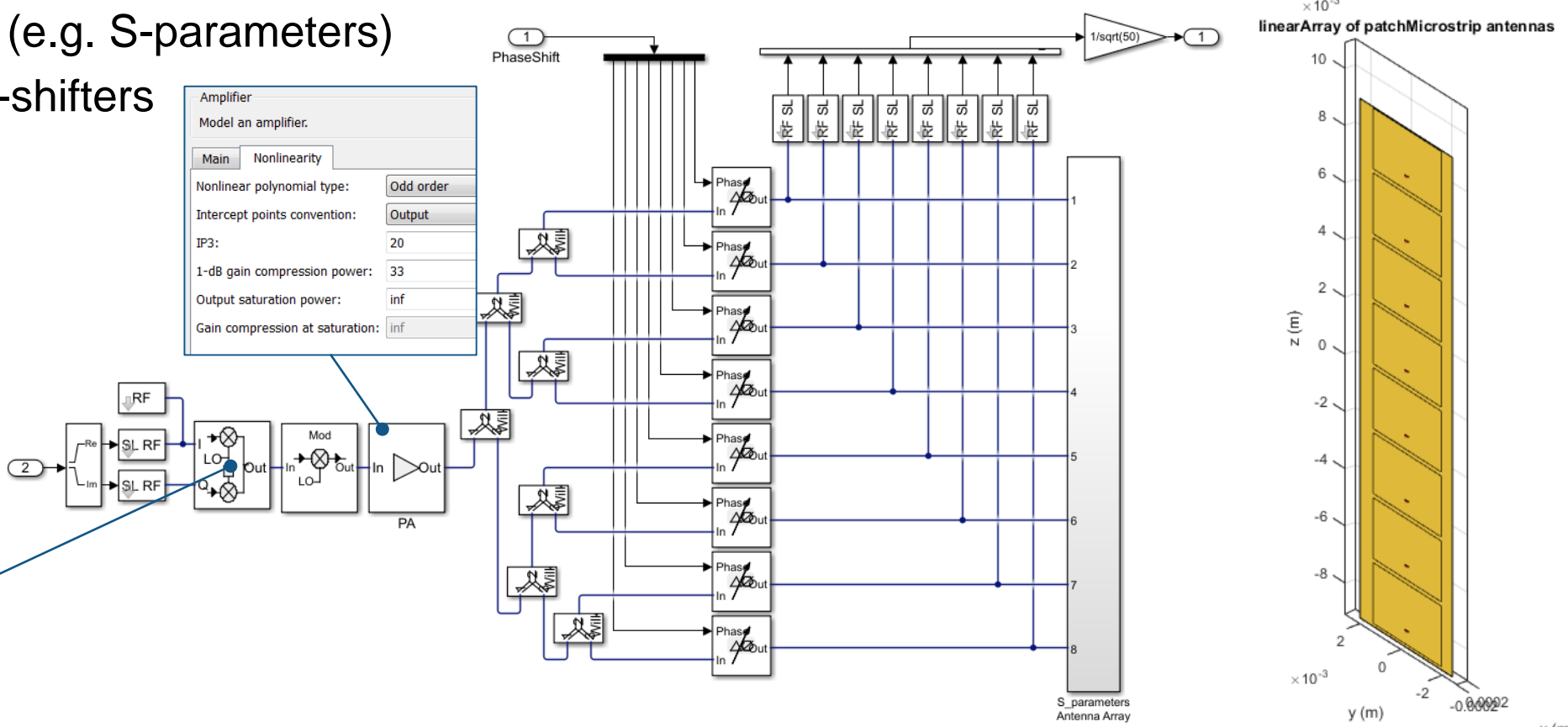

Amplifier
Model an amplifier.

Main Nonlinearity

Nonlinear polynomial type:

Intercept points convention:

IP3:

1-dB gain compression power:

Output saturation power:

Gain compression at saturation:

Block Parameters: IQ Modulator

IQ Modulator
Model an IQ modulator

Main Impairments Nonlinearity

I/Q gain mismatch: dB

I/Q phase mismatch: deg

LO to RF isolation: dB

Noise floor (dBm/Hz):

OK Cancel Help Apply

19

16

Hybrid Beamforming Transmitter Array

- 8 subarrays of 8 patch antennas operating at 66GHz \rightarrow $8 \times 8 = 64$ antennas
- Digital beamforming applied to the 8 subarrays (azimuth steering)
- RF beamforming (phase shifters) applied to the 8 antennas (elevation steering)

linearArray of patchMicrostrip antennas

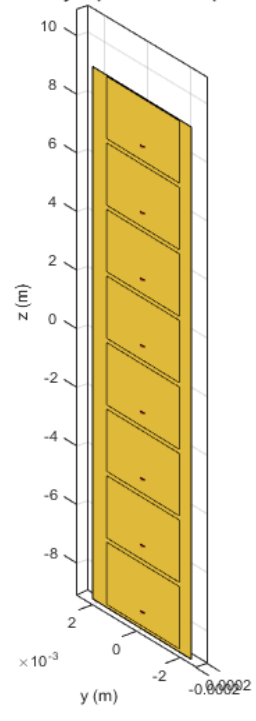

Array Geometry

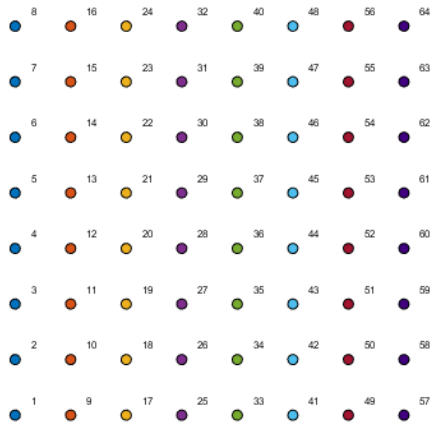

MATLAB EXPO 2019

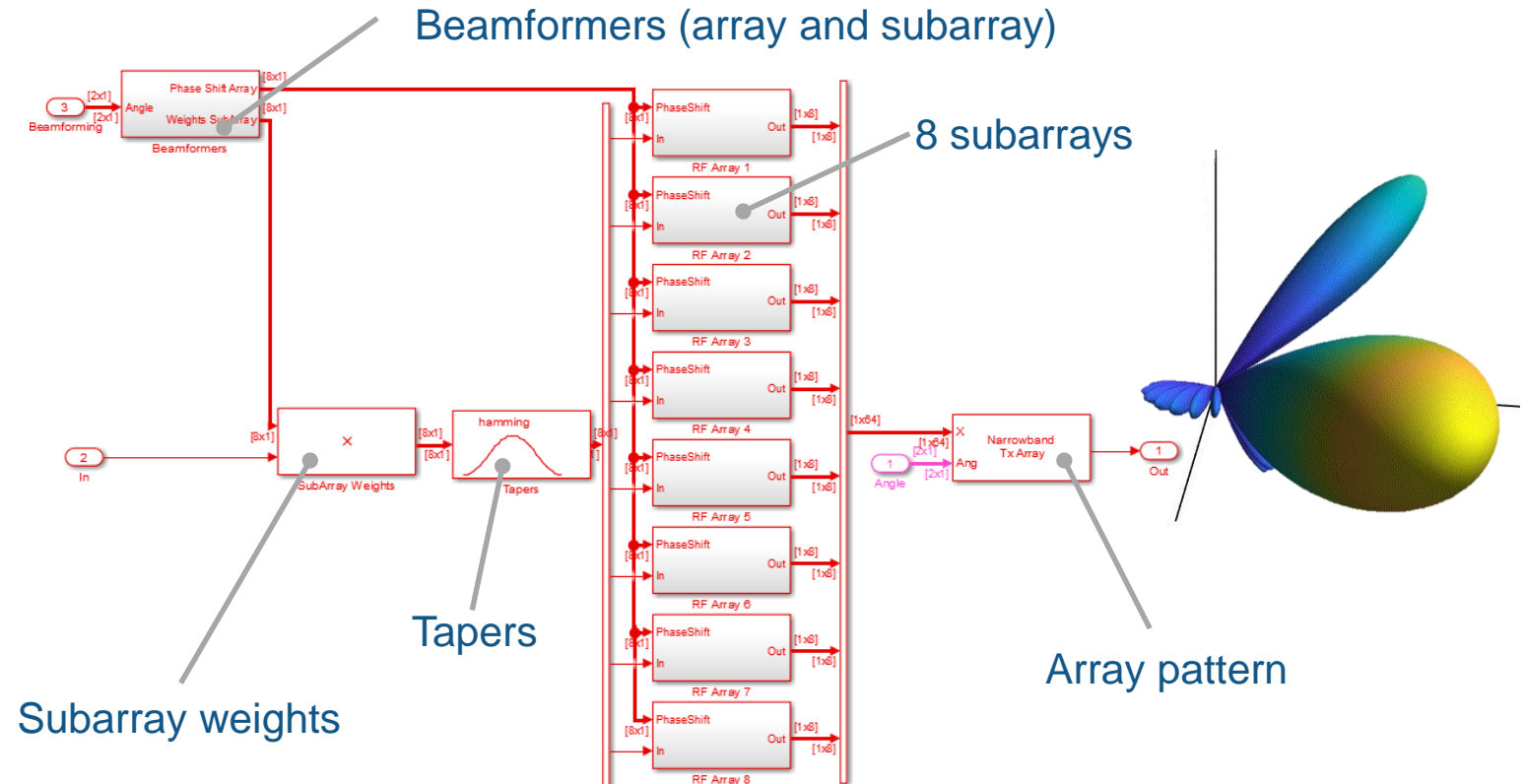

System Architecture for Hybrid Beamforming

[Download Whitepaper](#)

- The transmitter uses a larger array to perform beamforming towards the receiver
- The receiver estimates the direction of arrival with small orthogonal arrays and communicates it to the transmitter

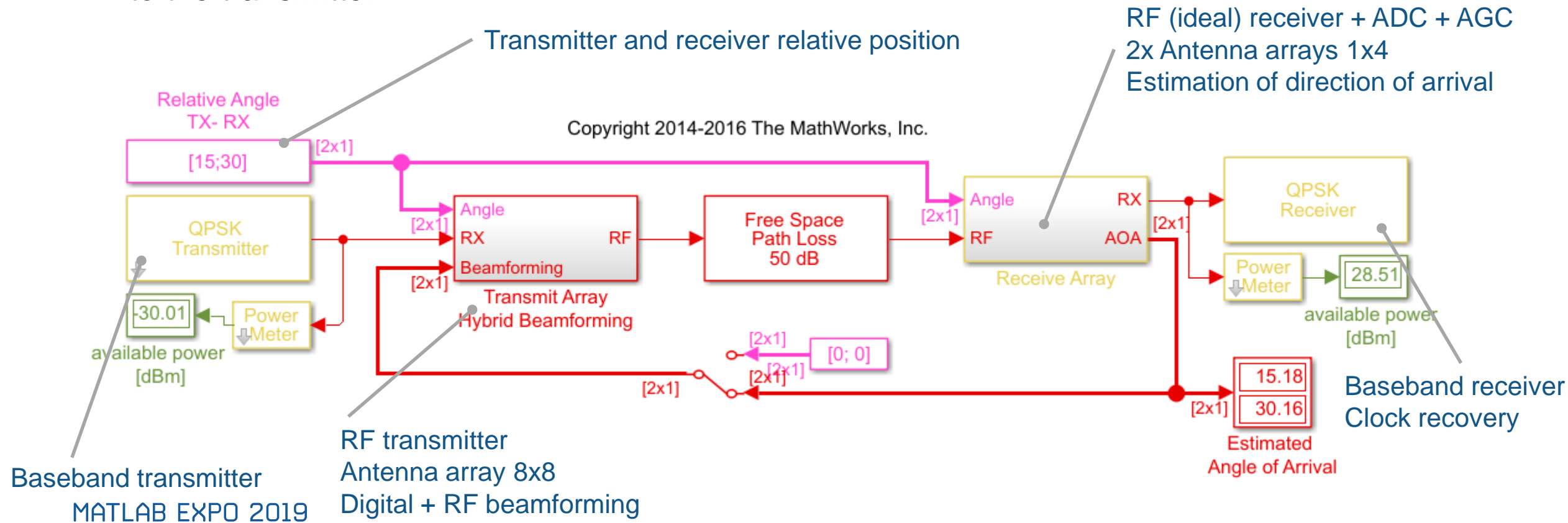

Agenda

RF Propagation & Network Coverage

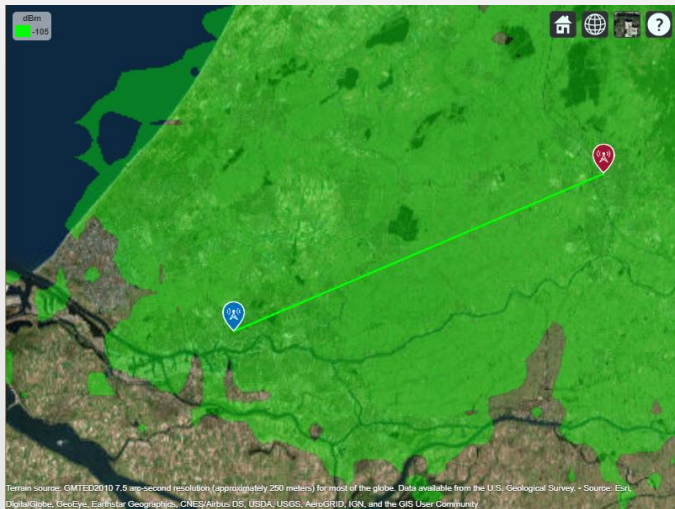

Beamforming for Multi-User Operation

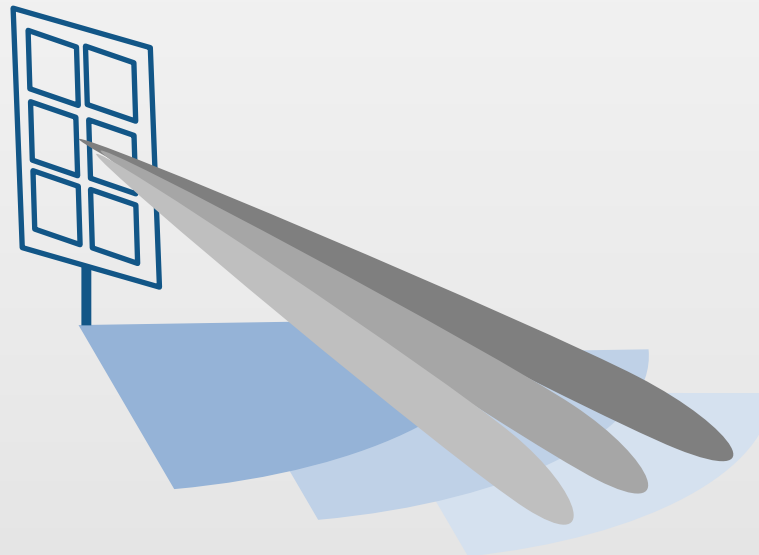

Power Amplifier & Digital Pre-distortion

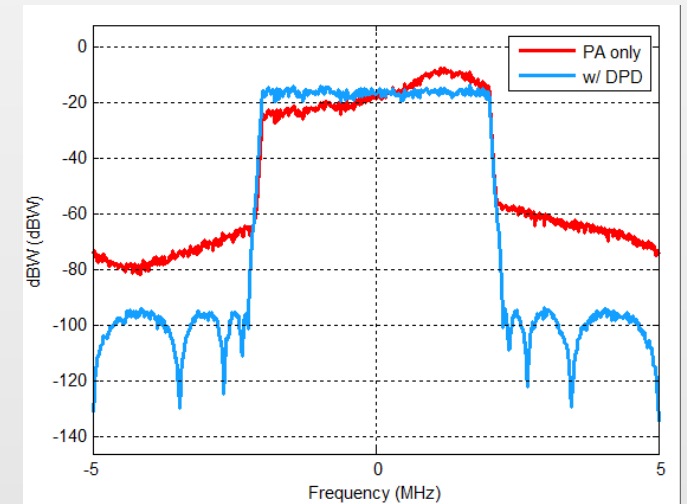

PA Linearization: Digital Pre Distortion (DPD) in Theory

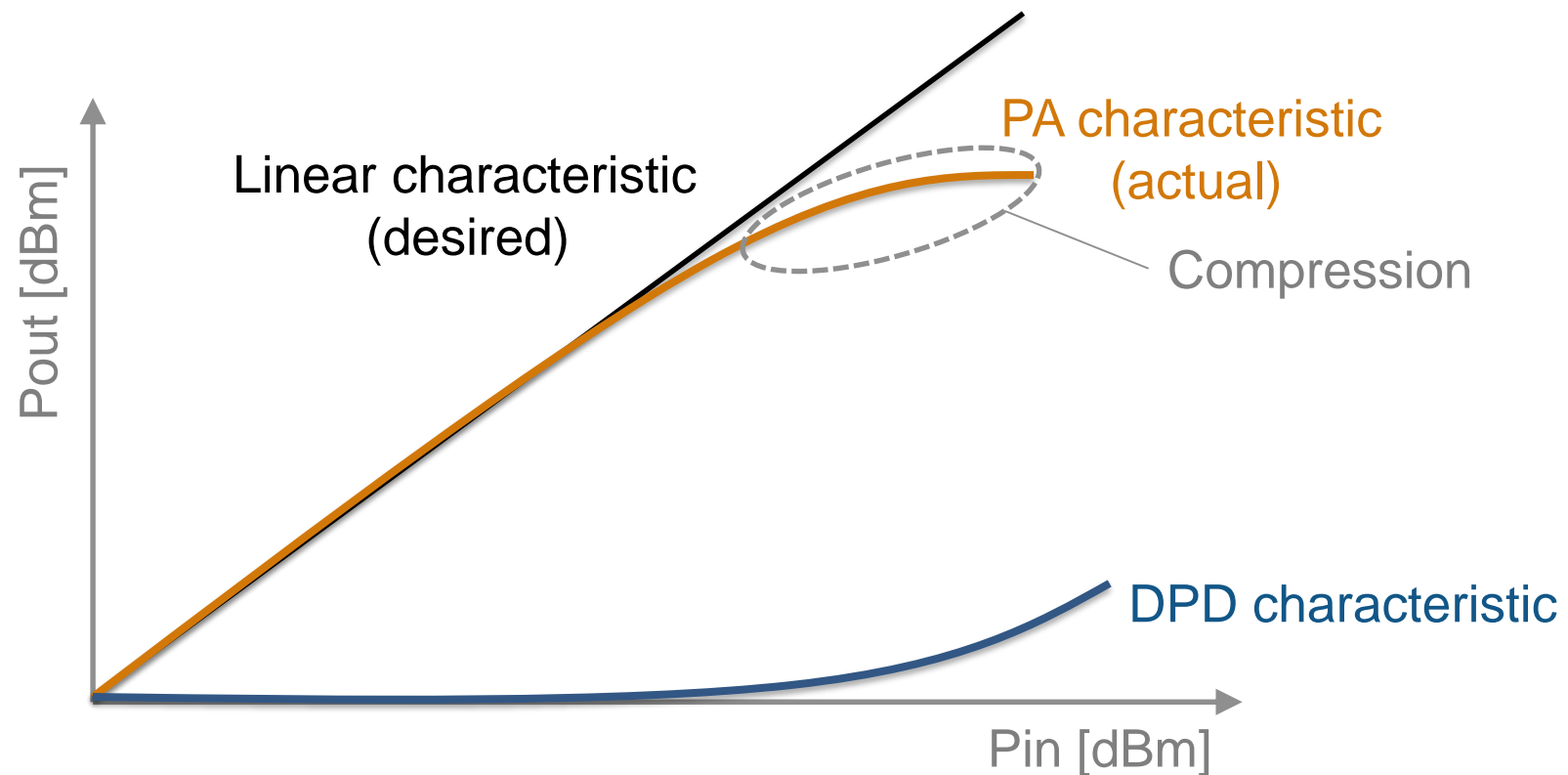
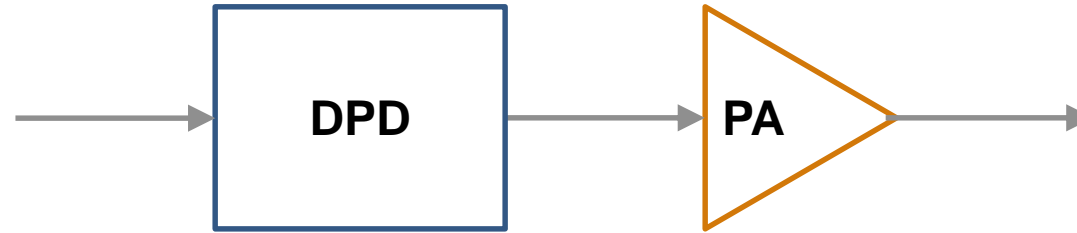

PA Linearization: Digital Pre Distortion (DPD) in Practice

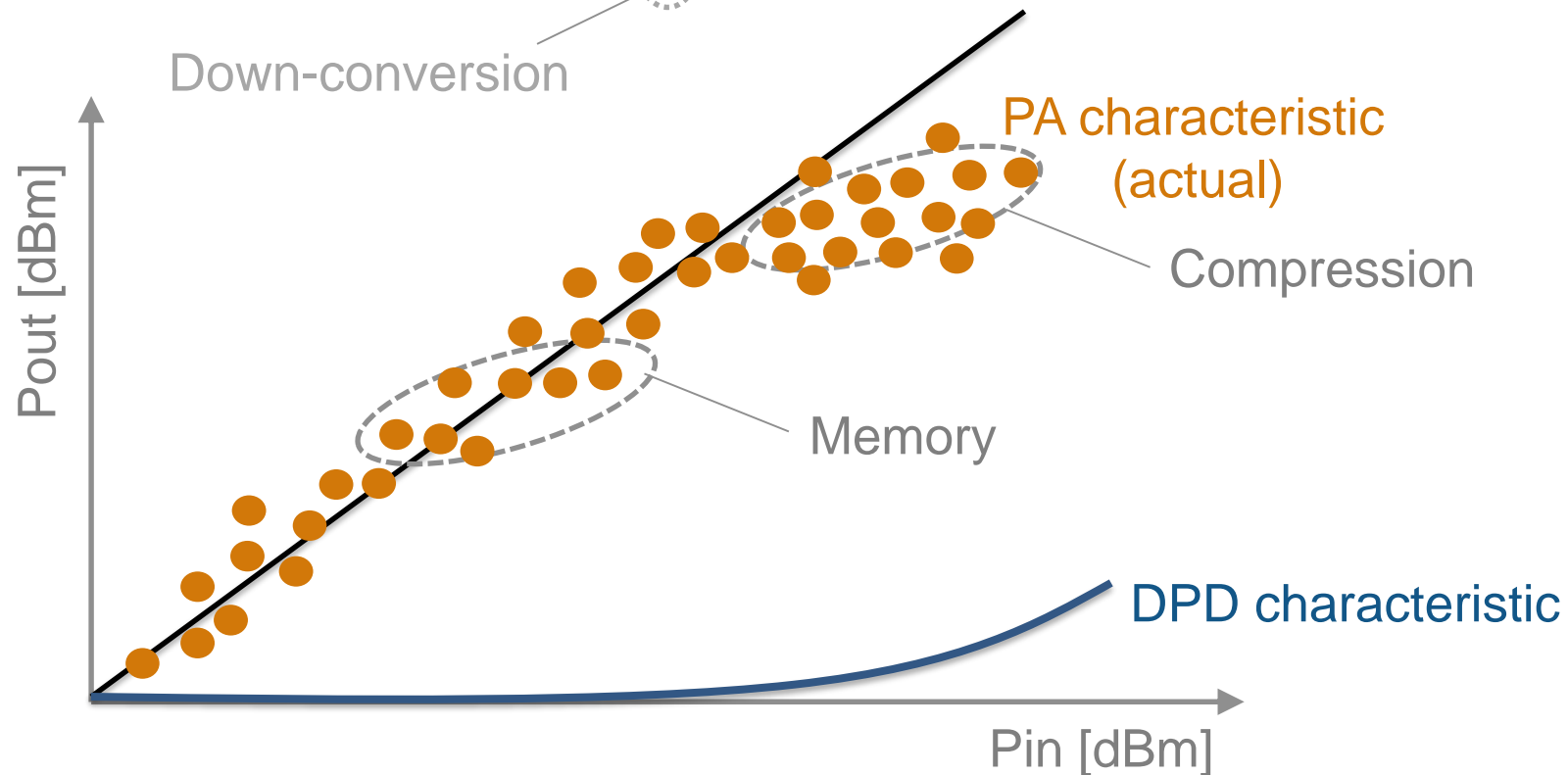
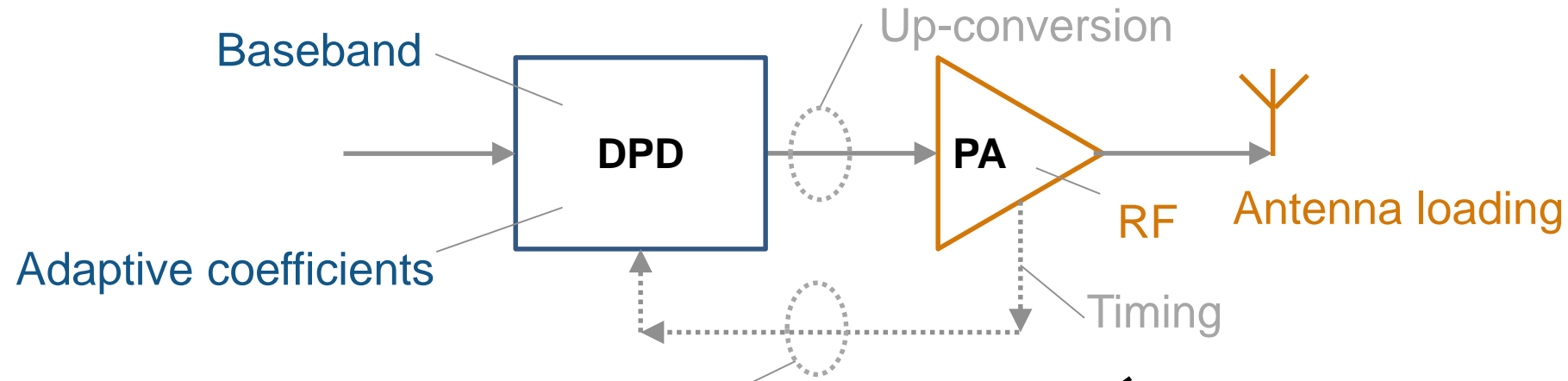

What resources are available to characterize a PA Model?

PA Data

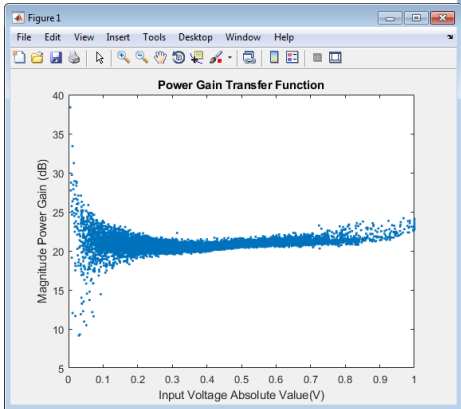
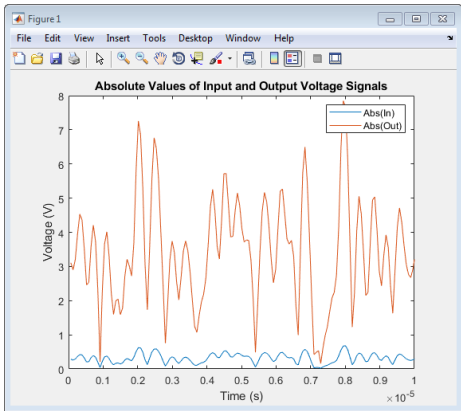

MATLAB fitting procedure (White box)

```
function a_coef = fit_memory_poly_model(x,y,memLen,degLen,modType)
% FIT_MEMORY_POLY_MODEL
% Procedure to compute a coefficient matrix given input and output
% signals, memory length, nonlinearity degree, and model type.
%
% Copyright 2017 MathWorks, Inc.

x = x(:);
y = y(:);
xLen = length(x);

switch modType
case 'memPoly' % Memory polynomial
xrow = reshape((memLen:-1:1)' + (0:xLen:xLen*(degLen-1)),1,[]);
xVec = (0:xLen-memLen)' + xrow;
xPow = x.*(abs(x).^(0:degLen-1));
xVec = xPow(xVec);
case 'ctMemPoly' % Cross-term memory polynomial
absPow = (abs(x).^(1:degLen-1));
partTop1 = reshape((memLen:-1:1)' + (0:xLen:xLen*(degLen-2)),1,[]);
topPlane = reshape(
[ones(xLen-memLen+1,1),absPow((0:xLen-memLen)' + partTop1)].', ...
1,memLen*(degLen-1)+1,xLen-memLen+1);
sidePlane = reshape(x((0:xLen-memLen)' + (memLen:-1:1)).', ...
memLen,1,xLen-memLen+1);
cube = sidePlane.*topPlane;
xVec = reshape(cube,memLen*(memLen*(degLen-1)+1),xLen-memLen+1).';
end

coef = xVec\y(memLen:xLen);
a_coef = reshape(coef,memLen,numel(coef)/memLen);
```

PA model coefficients

	1	2	3	4	5	6	7	8	9	10	11	12	13	14	
1	7.1756 + 1.1238i	57.1783 - 12.3324i	10.5876 - 7.5994i	-2.423... - 4.379... - 1.125... 24.61... 1.461... 4.390... -94.35... -2.338... -8.825... 1.934... 1.8...											
2	3.2336 - 0.7538i	-25.2834 + 7.1506i	-4.4593 + 13.8723i	-9.675... 2.191... 2.847... 1.131... -8.420... -9.565... -4.801... 1.563... 2.309... 9.079... -1.4...											
3	-1.6834 + 1.1150i	12.5544 - 6.4201i	-4.6721 - 4.7128i	16.98... -1.006... 51.69... -1.516... 3.683... -2.068... 5.637... -6.580... 3.495... -9.910... 5.7...											
4															
5															
6															
7															
8															

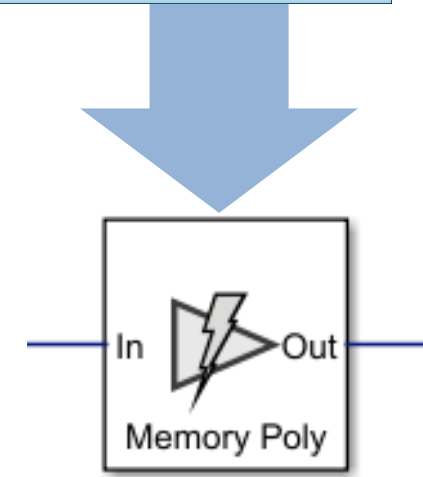
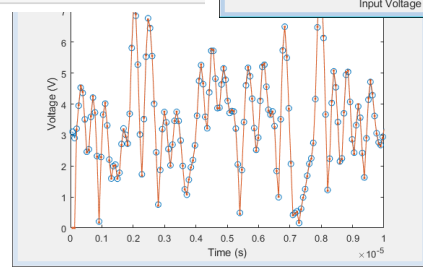
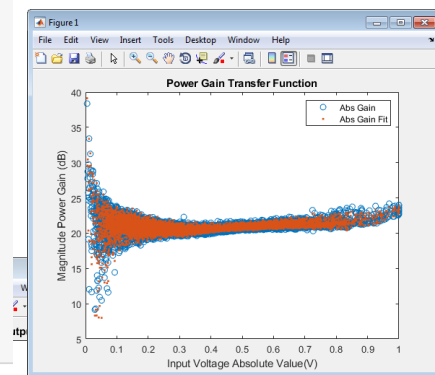
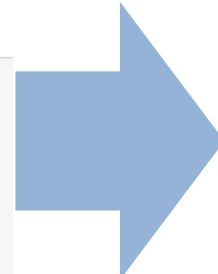

PA model for circuit envelope simulation

PA + DPD Simulation

- Circuit Envelope for fast RF simulation
- Low-power RF and analog components
 - Up-conversion / down-conversion
 - Antenna load
- Digital signal processing algorithm: DPD

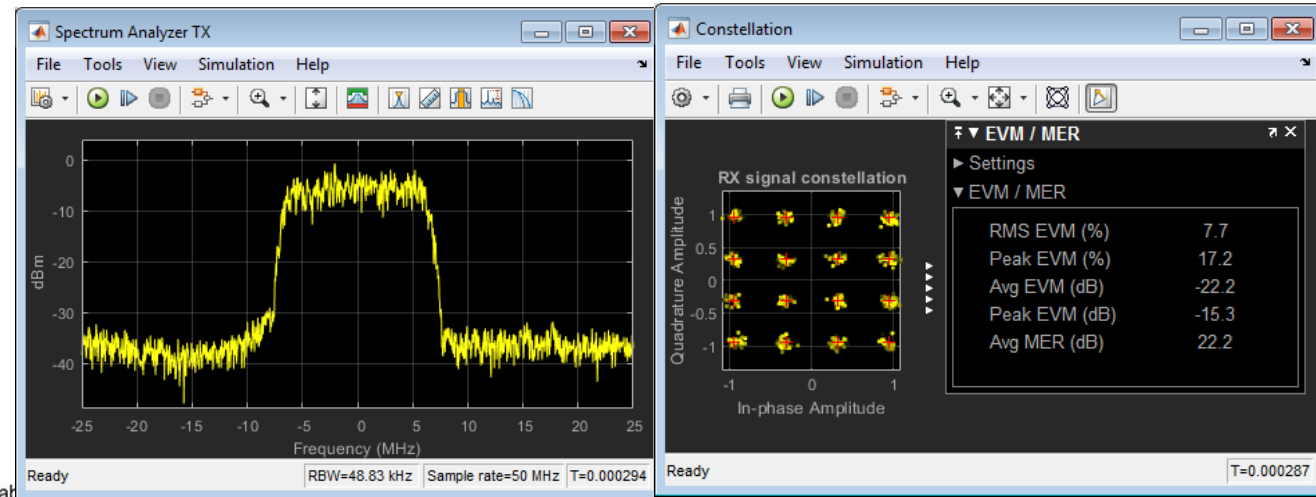

Block Parameters: DPD

DPD
Pre-distort a complex baseband signal using a memory polynomial to compensate for nonlinearities in a power amplifier.

[Source code](#)

Parameters

Polynomial type: Memory polynomial

Coefficient source: Input port

Simulate using: Code generation

Block Parameters: DPD Coefficient Estimator

DPD Coefficient Estimator
Estimate the coefficients of a memory polynomial of a nonlinear power amplifier.

[Source code](#)

Parameters

Desired amplitude gain (dB): 8

Polynomial type: Memory polynomial

Degree: 5

Memory depth: 5

Algorithm: Recursive least squares

Forgetting factor source: Recursive least squares

Forgetting factor: 0.99

Initial coefficient estimate: []

Simulate using: Code generation

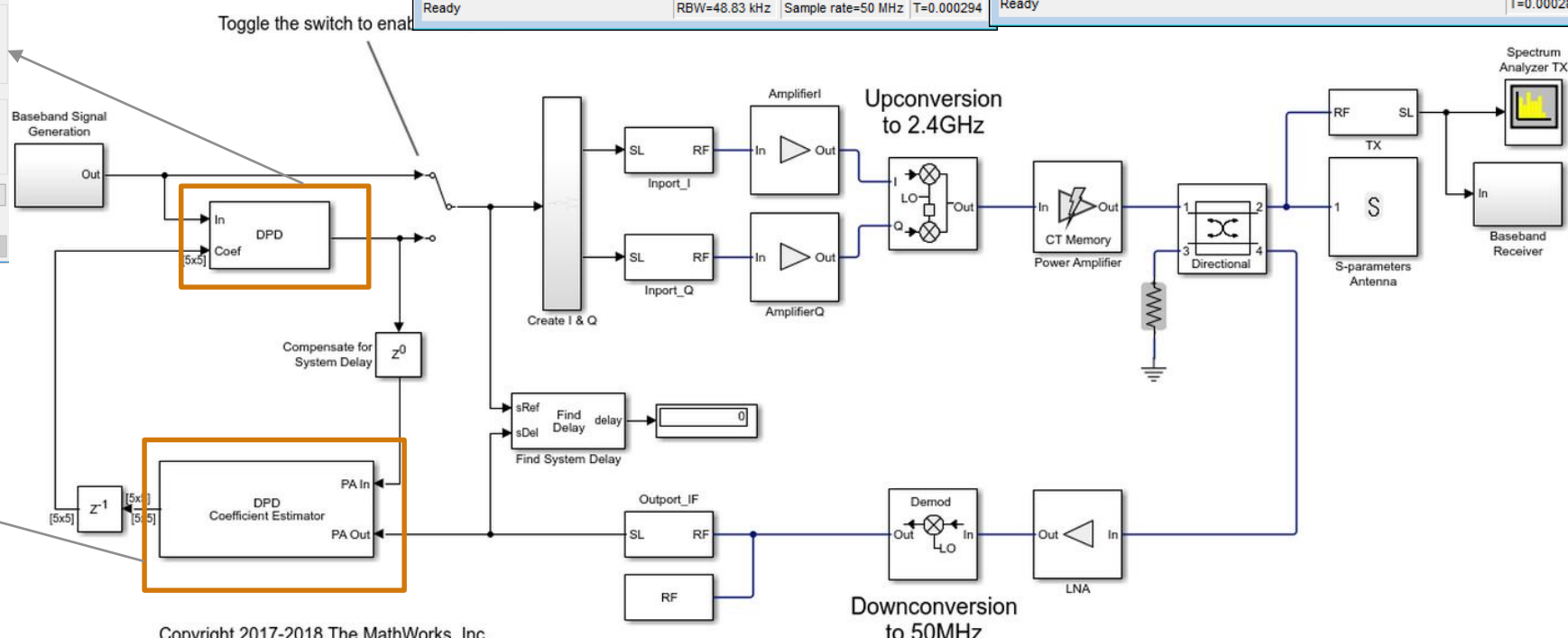

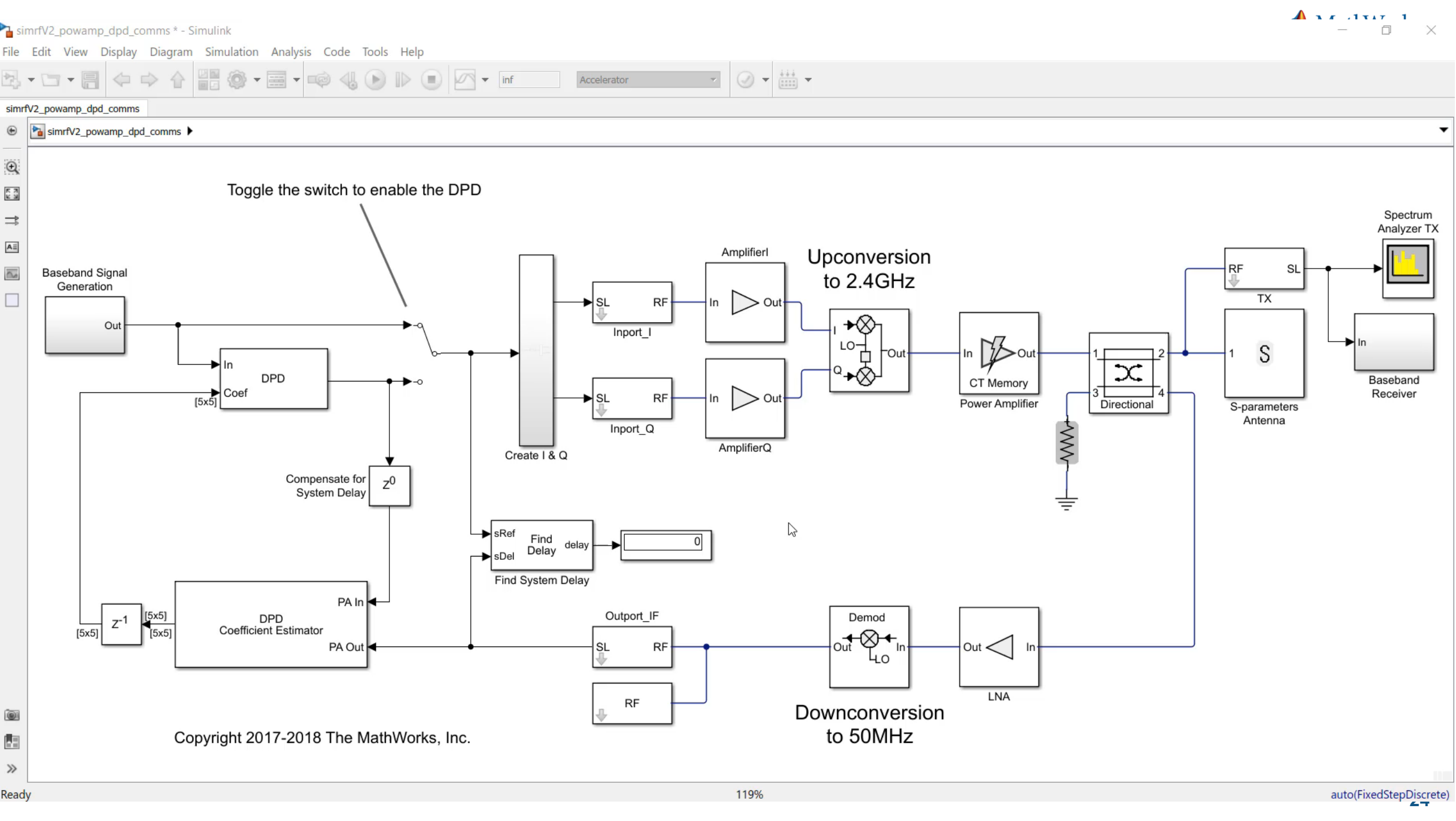

RF System Simulation Must Be Fast

RF Blockset allows you to deal with RF complexity with:

- Models at high levels of abstraction
- Solvers that use larger time-step

Deeper understanding of:

- Non-linear effects
- Noise generation
- Sources of signal distortion
- Impedance mismatches

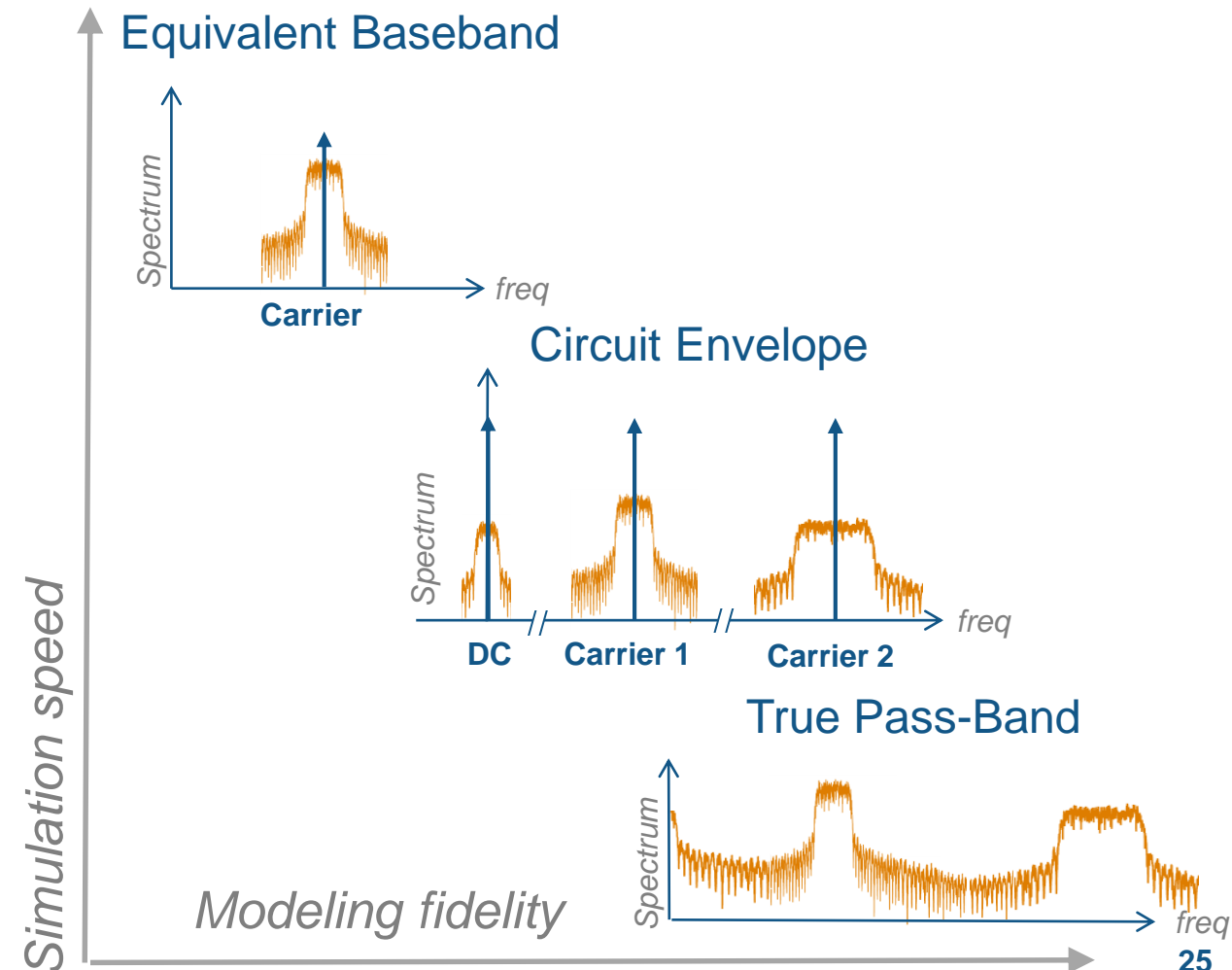

Developing a Radio Frequency System for Wireless at Huawei

Erni Zhu, Huawei

Huawei, in collaboration with MathWorks, developed an intermediate frequency (IF) and radio frequency (RF) system for 5G wireless base stations to achieve greater capacity, higher speed, lower latency, and more energy efficiency.

MATLAB® and Simulink® help Huawei address design and verification challenges including modeling and analysis of hybrid analog-digital systems, accelerating algorithm implementation with code generation, and automating verification. Huawei saved development time by efficiently creating designs early in R&D, which reduced debugging and verification effort.

Advantages of using MATLAB:

- Perform closed-loop simulation of designs containing both analog/RF and digital components, such as digital predistortion (DPD) for RF power amplifiers
- Quickly develop a flexible, high-performance hardware development platform at the beginning of the R&D process using a seamless interface to RF instruments
- Quickly build an automatic verification platform between software and hardware
- Use a single platform for hardware development, including reference models, fixed-point conversion, and automatic C and RTL code generation
- Reuse models for bit-true verification of floating-point, fixed-point, and RTL code



MATLAB and Simulink provide a **unified and efficient** system development platform to **bridge** between analog and digital; software and hardware; and algorithm, implementation, and verification.



DPD Algorithm Testing on Hardware-in-the-Loop

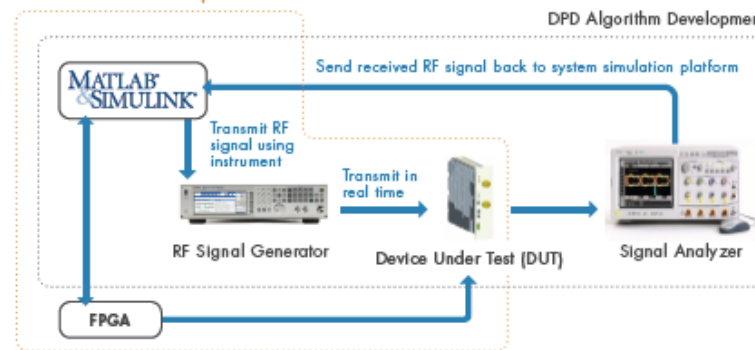

» Learn more about 5G wireless technology solutions

Presented at MATLAB EXPO 2017 China

▶ Watch video (in Chinese) 28:11

Wireless System Overview

MATLAB & Simulink as a Unified Platform

Algorithms, Waveforms, Measurements

- Communications Toolbox
- Phased Array System Toolbox
- LTE, WLAN & 5G Toolbox

```

Establish the number of component carriers.
numCC = length(NDLRB);

% Create transmission for each component carrier
enb = cell(1,numCC);
for i = 1:numCC
    enb{i} = lteRMCDL('R.5');
    enb{i}.NDLRB = NDLRB(i);

```

TRANSMITTER

RF Front End

- RF Toolbox
- RF Blockset

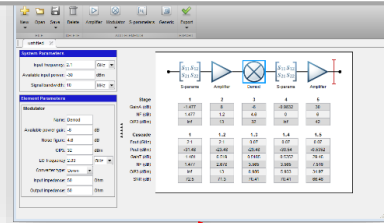

Antennas, Antenna Arrays

- Antenna Toolbox
- Phased Array System Toolbox

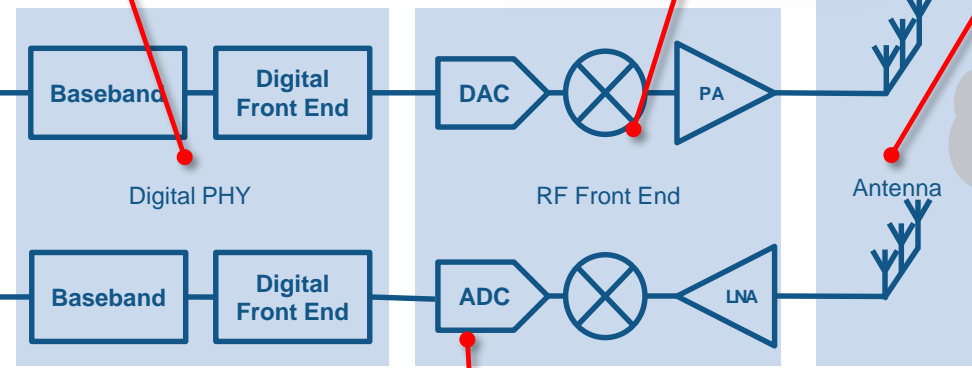
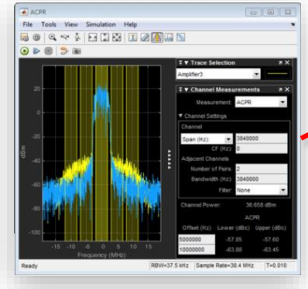
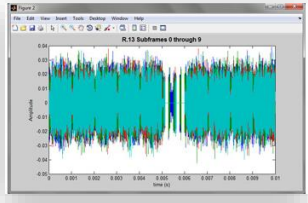
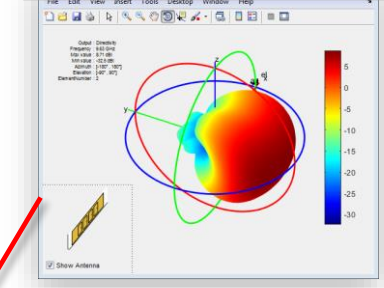

RECEIVER

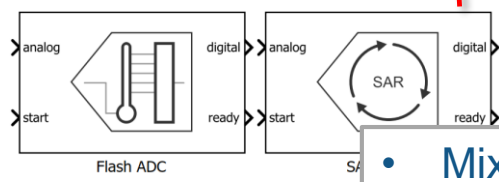

Mixed-Signal Design

- Mixed-Signal Blockset

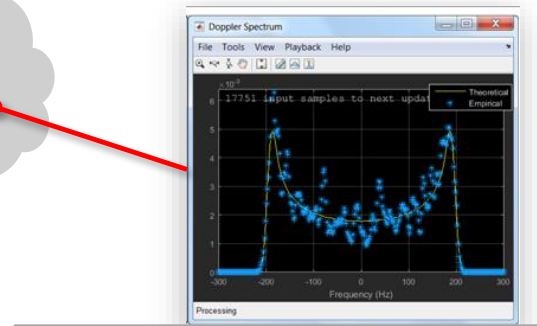
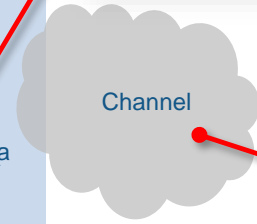

- Communications Toolbox
- Phased Array System Toolbox
- LTE, WLAN & 5G Toolbox

Channel Modeling

Resources to Help You Get Started

View web resources

[Mapping RF Propagation for Wireless Communications](#) (webinar)

[Modeling RF Power Amplifiers and Increasing Wireless Transmitter Linearity with DPD Using MATLAB](#) (webinar)

Read eBook and white papers

[5G Development with MATLAB](#) (eBook)

[Hybrid Beamforming for Massive MIMO Phased Array Systems](#) (white paper)

[Four Steps to Building Smarter RF Systems with MATLAB](#) (white paper)

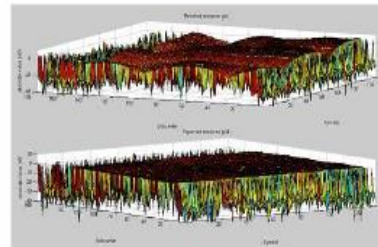

Conformance Testing

Ensure your designs comply with the supported 3GPP LTE standard releases.

» Learn more

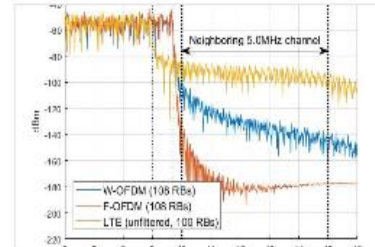

5G Library

Simulate 3GPP 5G new radio technologies.

» Learn more

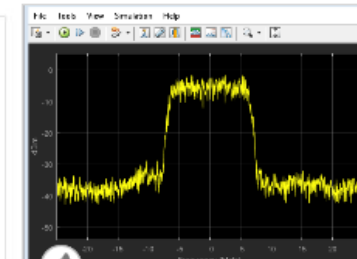

Power Amplifier Characterization with DPD for Reduced Signal

Provides a methodology for characterizing a nonlinear RF Blockset™ power amplifier (PA) with memory and an adaptive DPD

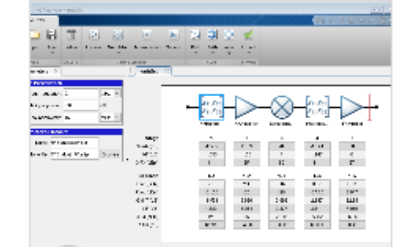

Visualizing RF Budget Analysis Over Bandwidth

Programmatically perform an RF budget analysis of an RF receiver system and visualize computed budget results across the bandwidth

R2018a

R2018a

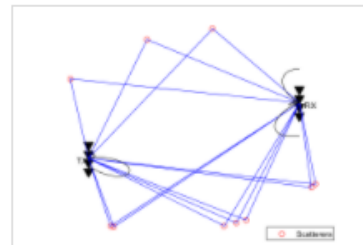

Improve SNR and Capacity of Wireless Communication Using...

The goal of a wireless communication system is to serve as many users with the highest possible data rate given constraints

Open Script

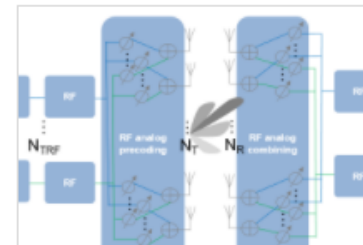

Introduction to Hybrid Beamforming

Introduces the basic concept of hybrid beamforming and shows how to simulate such a system.

Open Script

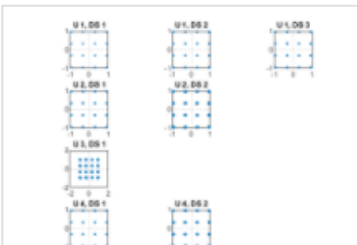

Massive MIMO Hybrid Beamforming

How hybrid beamforming is employed at the transmit end of a massive MIMO communications system, using techniques for both

R2018a



SINR Map for a 5G Urban Macro-Cell Test Environment

This example shows how to construct a 5G urban macro-cell test environment and visualize the signal-to-interference-plus-noise

R2018a

MathWorks® | Training Services

RF System Design using MathWorks Tools

- Introduction to RF simulation using MathWorks tools
- How do I model my RF system with RF Blockset?
- Importing S-Parameters and modeling linear operation
- Fundamentals of noise simulation
- Modeling non-linear devices
- Developing custom models

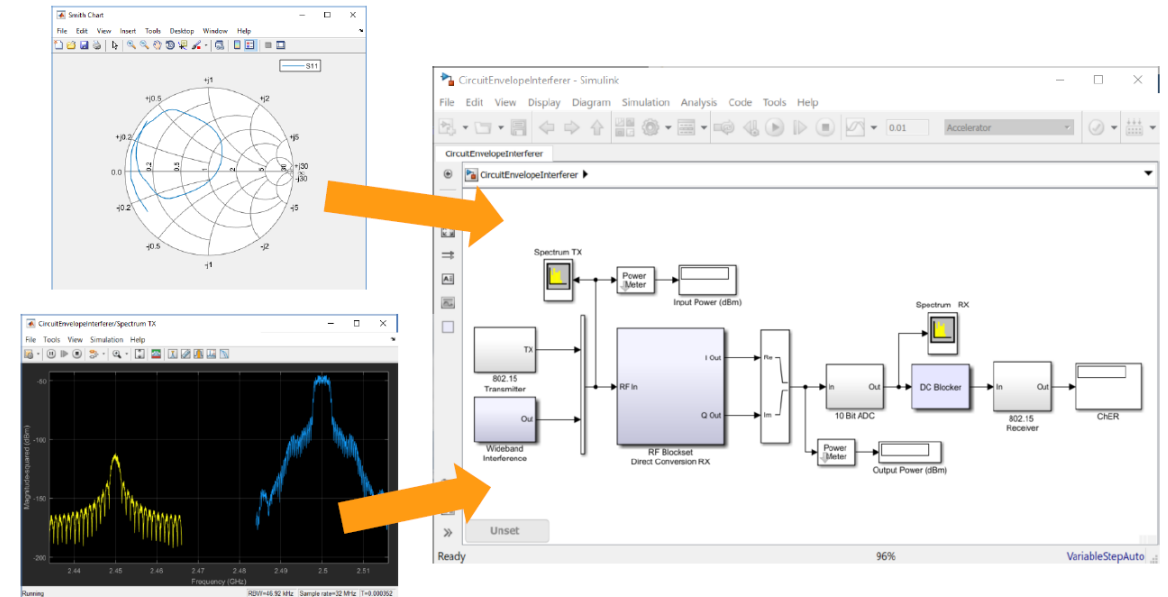

Please provide feedback for this block of sessions

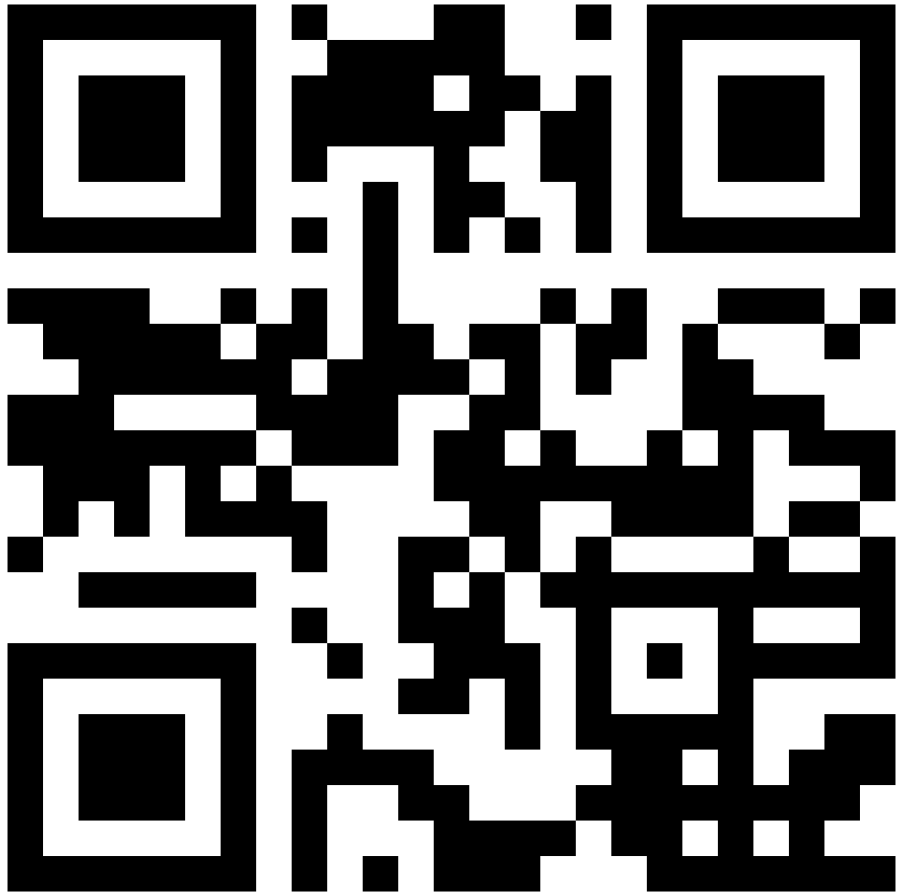

- Scan this QR Code or log onto link below (link also sent to your phone and email)
- <http://bit.ly/expo19-feedback>
- Enter the registration id number displayed on your badge
- Provide feedback for this session

Email: vidyav@mathworks.com

LinkedIn: www.linkedin.com/in/vidyaviswanathan