

Simulation & Predictive Maintenance Application

28-May-2019



Key Takeaways

- **Listening and Pivoting**
- **Collaboration**
- **Flexibility**



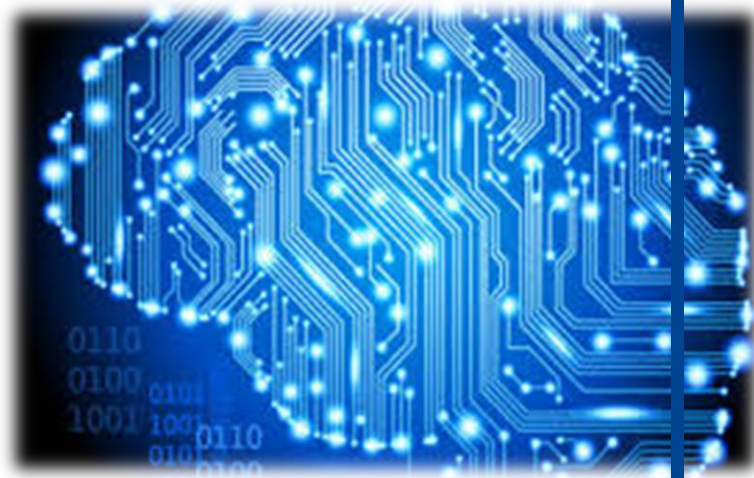

SIMULATION & PREDICTIVE MAINTENANCE

SAFRAN APPROACH

SAFRAN – Simulation History

2015 Q1.

First Artificial Neural Network (ANN) to solve Structural Health Monitoring SHM problem

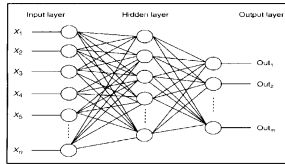

2016 Q1.

Assessment of random noise effect in SHM
EWSHM-2016 – Congress Bilbao (Spain)

2017 Q2.

ANN approach to predictive analysis of rotary industrial machines

2018 Q1.

Marketing development & Customer seeking

Hydraulic Press
Hydro-electric generator
Variable Frequency Generator (VFG)
Automotive tire vulcanizing furnace applications



Today

First bench-markings with potential customers and collaborators

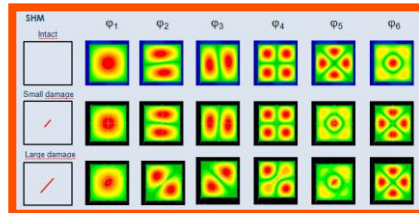

Collaboration

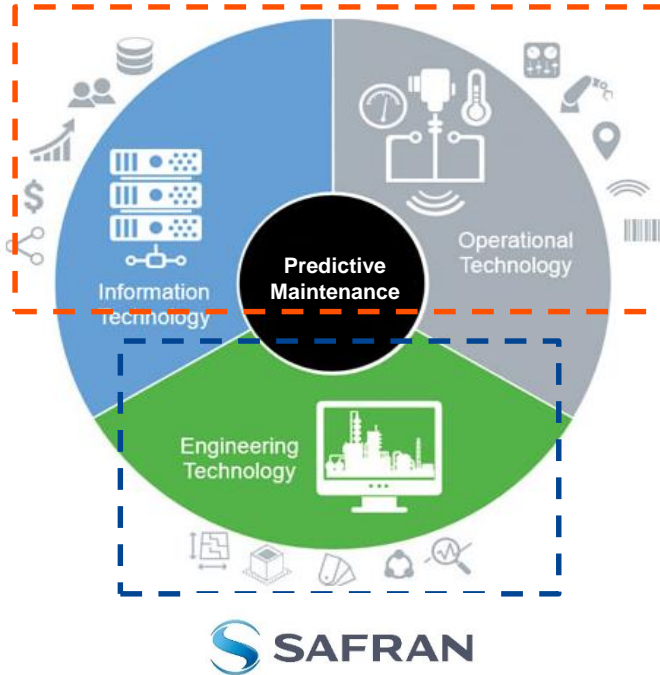

Smart Predictive Maintenance requires for three different Technologies: IT, OT and ET.

1. Information Technology to analyze historical Big Data.
2. Operation Technology to obtain data in streaming from real process.
3. Engineering Technology to identify physical behaviors and simulate run-to-failure data.

Engineering Technology – Digital Twin



1. Due to traditional Maintenance Cycles, run-to-failure data are normally missing from collected Data Base.
2. Run-to-failure data are necessary for Smart Prediction.
3. Digital Twins simulate anomalies to generate these data.
4. Digital Twins follow Physical Responses.

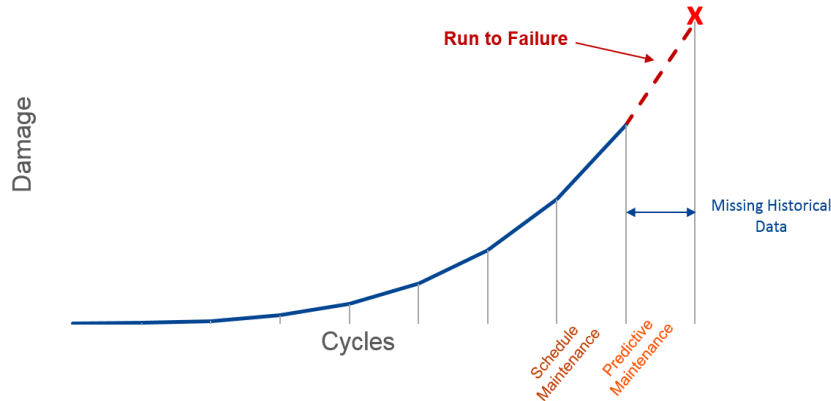

Engineering Technology – Engineering Taxonomy

- Digital Twins are applicable to any level of taxonomy.
- The whole corporation can be connected by using Simulated Process.
- Digital Transformation is mandatory for any company for future developments.

Engineering Taxonomy

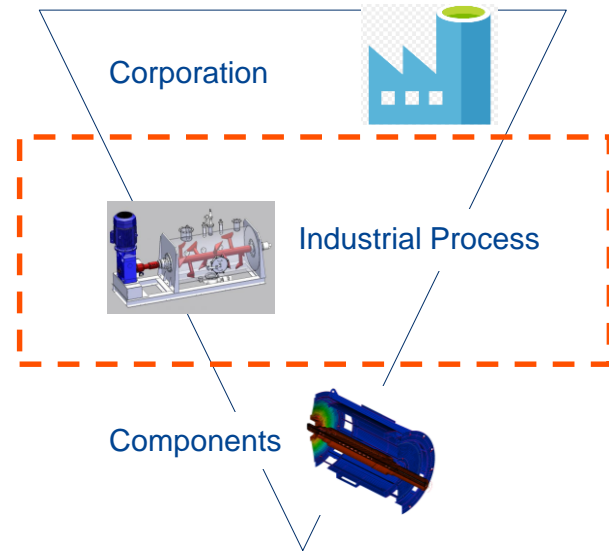

INDUSTRIAL PROCESS APPLICATION

Hydraulic Press



Application – Hydraulic Press

Methodology

1. Preliminary analysis:

- Monitor for collecting calibration data.

2. Simulation model:

- Create Parametric Virtual Model with Simulink.
- Correlate with calibration data.
- Generate anomalies (Data Base).

3. Neural Network supervised training:

- ANN generation/training with Deep Learning Toolbox.

4. Implementation of the predictive model:

- Synchronize active monitoring and predictive maintenance model.
- Develop interface for friendly user experience with GUI Layout Toolbox.



Application – Hydraulic Press

1. Model of the hydraulic press

- Hydraulic double acting cylinder
- 4 ways - 2 positions valve
- Pump
- Safety valve

2. Control

- Controlled by a variable time signal, piloting the main valve.

3. Monitoring

- Only 3 sensors: Position, Up-press, Down-press.

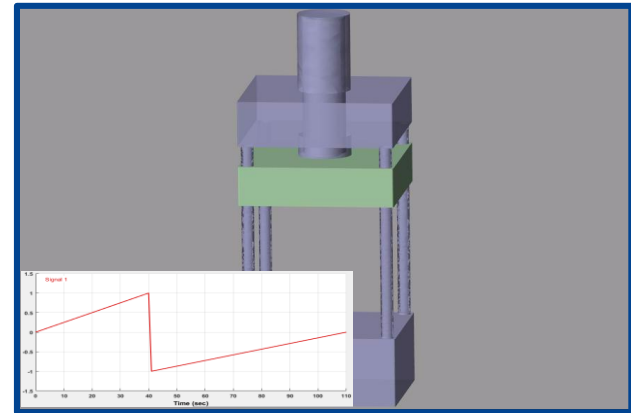
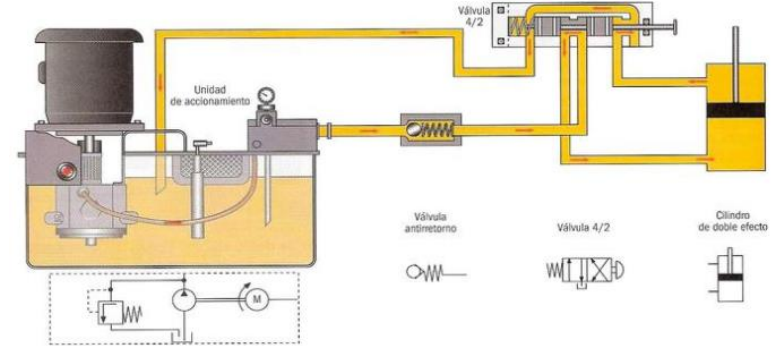

Application – Hydraulic Press

Simulink - 1D Virtual Model

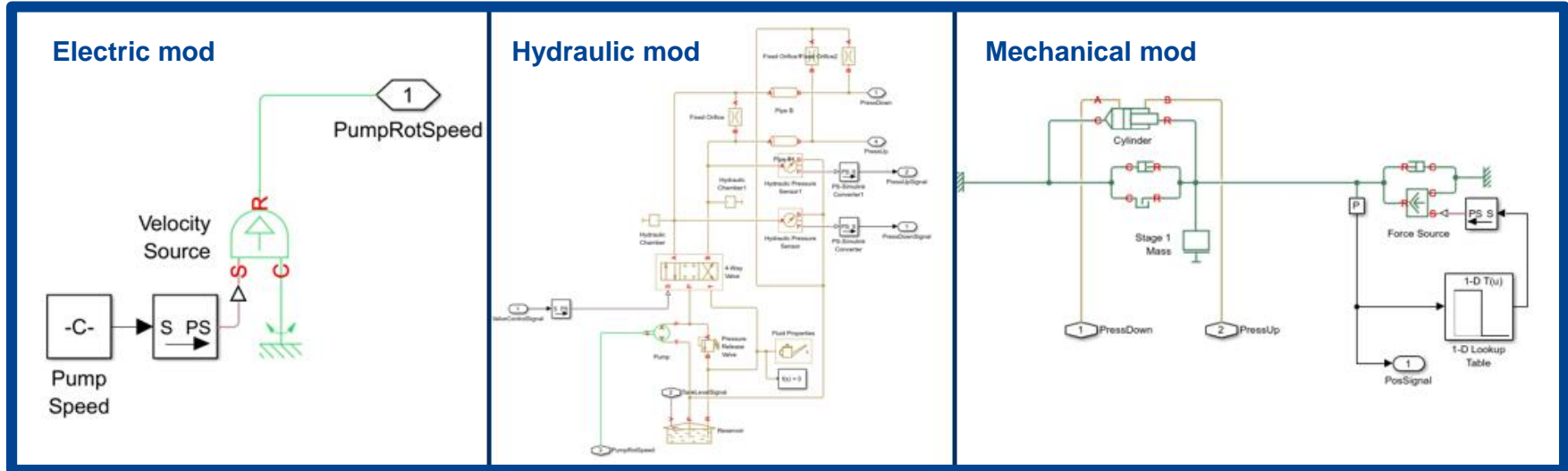

Application – Hydraulic Press

1. Anomalies simulation

- Parametric model → scenarios (anomalies progressive growth or abrupt).

2. Anomalies list

- Decrease of Pump rotation speed.
- Delay of the control valve.
- Pressure of the safety valve.
- Valves leakages.
- Bypass between up and down circuits.
- Hydraulic lines leakages.

3. Sensitivity analysis of anomalies

- Sensor impact.

4. Damage Qualification

- Determine damage boundaries for alerts.

Anomalies



```
input.pumprotatingfactor=1; % Pump rotating speed modification factor speed*factor
input.sequencedelayfactor=1; % Delay factor to multiply on the valve actuating sequence time*factor
input.pressreleasesettingfactor=1; % Release valve pressure activation modification factor press*factor
input.pressreleaseregulationfactor=1; % Release valve pressure range modification factor press_range*factor
input.pressreleaseleakagefactor=1; % Release valve leakage area modification factor area*factor
input.valveleakagefactor=1; % Actuating valve leakage area modification factor area*factor
input.valvederivativefactor=1; % Actuating valve derivation area modification factor area*factor
input.pressdownleakagefactor=1; % Pressure down line leakage area modification factor area*factor
input.pressupleakagefactor=1; % Pressure up line leakage area modification factor area*factor
```

+ 2500 scenarios!!

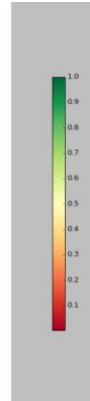
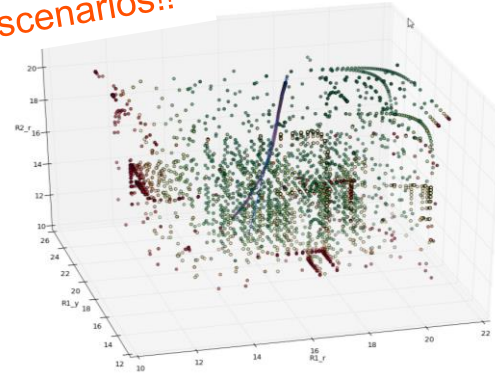

Application – Hydraulic Press

1. Data base

- NN Dataset & Training is developing by switching Input-Output.

2. ANN Generation

- Build the ANN architecture with Deep Learning Toolbox.

3. Training

- Adjust relative neural parameters to reach desired values.

4. Validation

- Iterative process using physical inputs to validate ANN and Virtual Model.

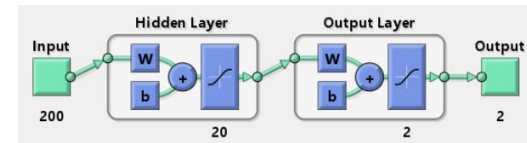
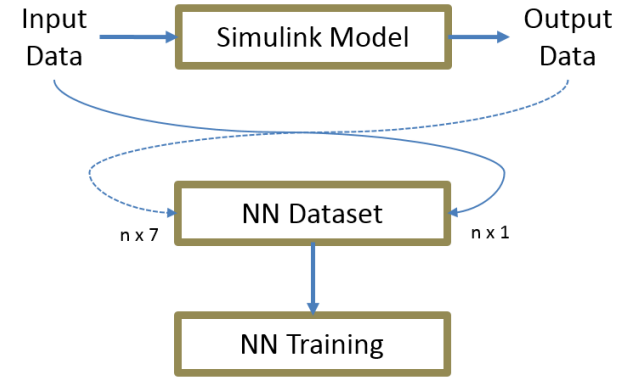

Supervised learning
process

Application – Hydraulic Press

GUI Layout Toolbox



Measure Id	Die Position Mean (m)	Max Die Position (m)	Die Velocity Mean (m/s)	Die Acceleration Mean (m/s ²)	Pressure Down Mean (Pa)	Pressure Up Mean (Pa)	Pressure Diff Mean (Pa)
1	0.23887042	0.84838813	-1.06516E-06	1.41305E-06	1158562	3602790	-2444228
2	0.23889914	0.84838824	-1.06437E-06	1.42052E-06	1161152	3605468	-2444316
3	0.23892845	0.84838834	-1.06359E-06	1.41794E-06	1164127	3608195	-2444408
4	0.23894948	0.79627293	0.00274152	-4.54182E-17	2156149	3096192	-930042
5	0.19327594	0.82691477	-1.3889E-06	2.48222E-07	804838	3587715	-2782878
6	0.42341755	0.84832075	0.00350513	2.04229E-05	1604374	2702123	-1097749

Predictive Maintenance -preview- v0.1.3

Predictive Maintenance
AEROSPACE DEFENCE SEC

Current State

Load Data
Calculate

Magnified view

Failure detection result: Failure detected: P = 100%
Failure classification not determined: possibilities:
fn5: Release valve leakage: P = 53.09%

v0.1.3

Predict

Load Data
Prediction
Generate report

0% 20% 40% 60% 80% 100%

Save Exit

Login -preview- v0.0.7

SAFRAI
AEROSPACE DEFENCE SEC

Please log in to continue:

User: _____
Dev: _____
Password: _____

Login
Cancel

Predictive Maintenance

Failure detection result: Failure detected: P = 100%
Failure classification not determined: possibilities:
fn5: Release valve leakage: P = 53.09%

Predictive Maintenance

Predictive Maintenance

Predictive Maintenance

SAFRAN SIMULATION APPLICATIONS

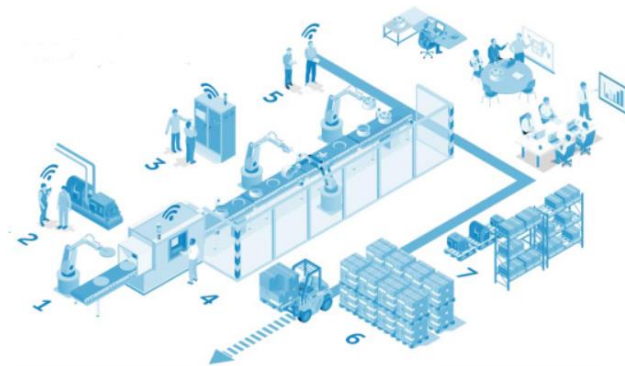

Application – Work Load Distribution

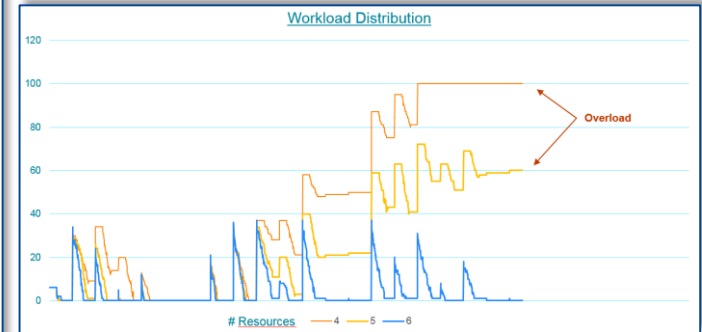
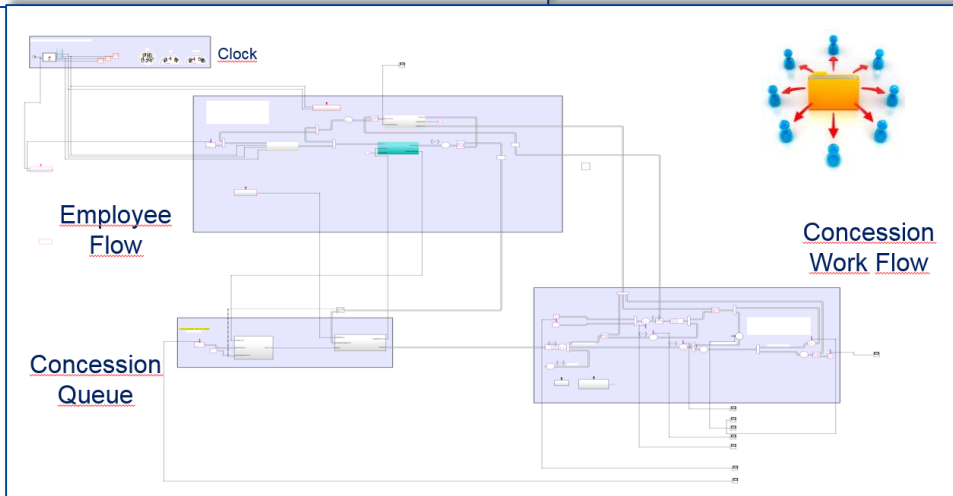
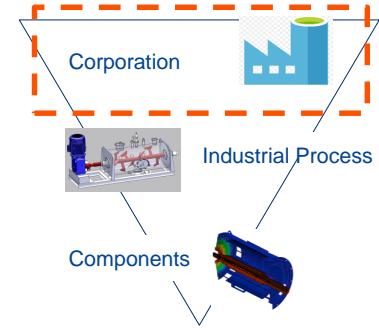
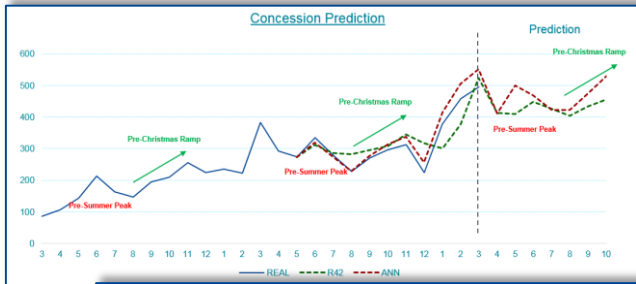

Application – Tire Vulcanizing Furnace

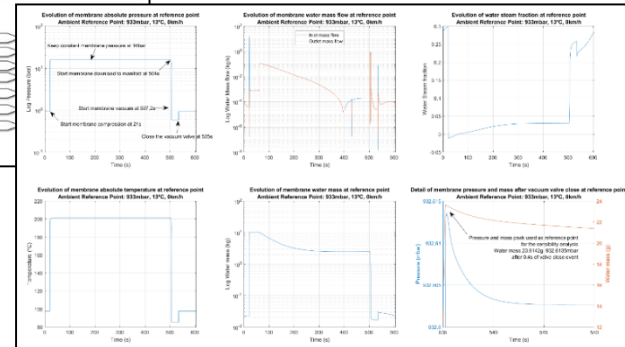
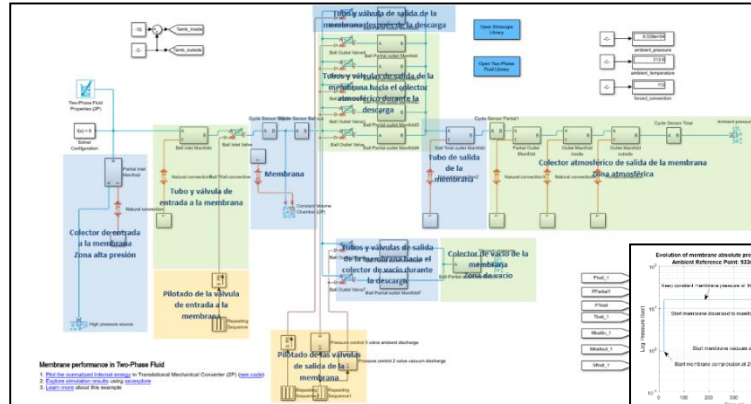
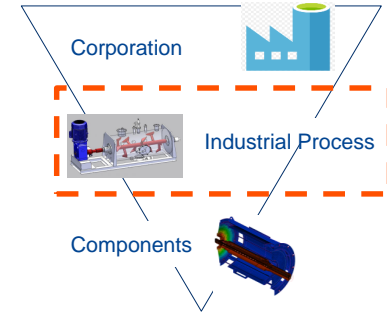
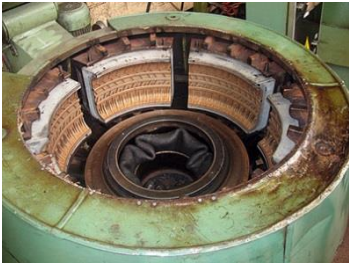

Application – Electric Generator

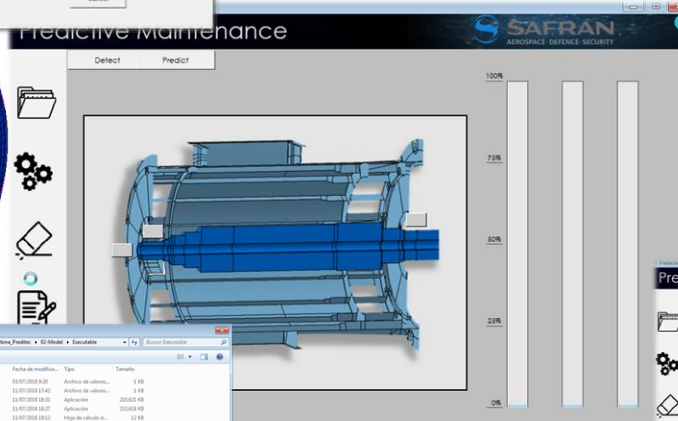
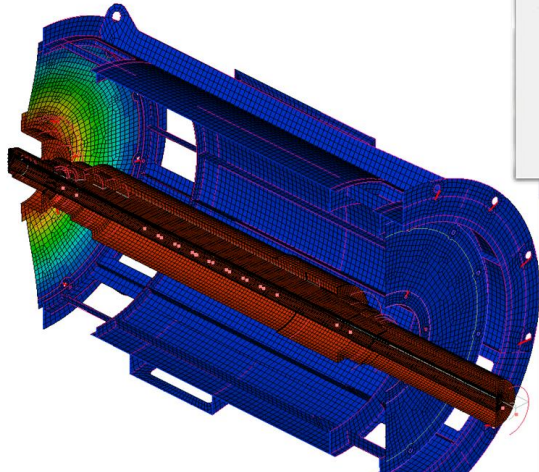

Windows Explorer window showing a file tree for 'Mantenimiento Predictivo' and a 'Excel Escalador' spreadsheet.

	A	B	C	D	E	F	G
1	1	18.4517	18.5281	19.3763	41.7484	45.0457	45.742
2	2	19.374	19.9948	20.0946	41.7484	45.6689	46.3604
3	3	18.8027	31.7452	32.2639	41.7484	62.6329	63.4403
4	4	19.3169	31.8448	32.3685	41.7484	63.0428	63.8623

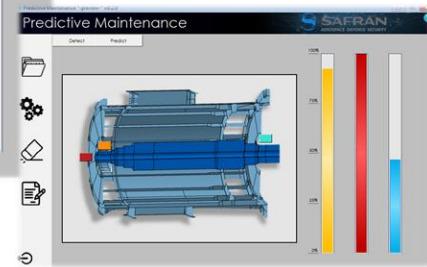
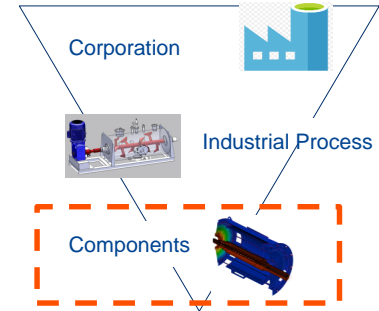

LESSONS LEARNT

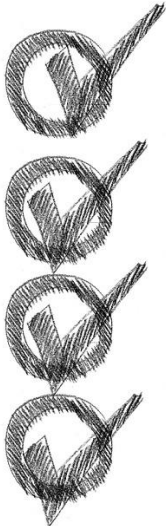

Lessons learnt

- **Listening customers to pivot from SHM to Simulation & Predictive Maintenance.**
- **Finding collaboration to keep growing knowledge and portfolio.**
- **Adapt processes to be flexible for customer demands.**



**POWERED
BY TRUST**



Iván Pérez



ivan.perez-salido@safrangroup.com